

SCMS SCHOOL OF ENGINEERING AND TECHNOLOGY, KARUKUTTY

ACADEMIC YEAR MAY 2019-JUNE 2020

3.5.1. Number of functional MoUs/linkages with institutions/ industries in India and abroad for internship, on-the-job training, project work, student / faculty exchange and collaborative research during the last five years

Sl. No	Name of the MoU / linkage	Name of the institution / industry with whom the MoU / linkage is made, with contact details	Year of signing MoU / linkage	Purpose of the MoU/Linkage (nternship, on-the-job training, project work, student / faculty exchange and collaborative research)	Duration of MoU / linkage	List the actual activities under each MOU/ Linkage and web -links year-wise
1	MoU	Hungkuang University, Taiwan R.O.C, Dr. Yueh-guey Huang, President, Hungkuang University,	2018	Academic and cultural exchange between two countries	2018-2025	Student exchange, Faculty development, Academic programmes
2	MoU	Shimane University, Japan , Yasunao Hattori President Shimane University	2018	Student exchange and to promot research. education and academic culture	2018-2025	Student exchange as part of intership
3	MoU	Daffodil International University, Yousuff Mahbubul, Vice chancellor	2018	Academic aad cultural exch	2018-2023	Other Academic Activities
4	MoU	Kochi Metro Rail Limited, Managing Director, Kochi Metro Rail	2018	FIELD PROJECT	2018-2021	Field Project
5	MoU	Furtwangen University of Applied Sciences, Germany	2015	Joint conferences, Joint teaching	2015-tiil date	Interaction with B.Tech students

6	MoU	Hermann Sewerin GmbH	2015	Providing of qualified project support and support and training of staff or students	2015-till date	Organized workshop on leak detection and pipe locating were conducted at SSET
	MoU	LimCo International GmbH, Germany	2015	For developing and applying new technologies and to adapt approved technologies to the specific tropical conditions	2015-till date	Student training at LimCo ,Germany
7	MoU	University of Applied Sciences Ravensburg-Weingarten, Germany	2015	Cultural exchange and exchange of undergraduate and graduate students as well as faculty	2015-2020	Student excgane and collaborative research
8	MoU	NIVUS GmbH	2015	For developing and applying new technologies and to adapt approved technologies to the specific tropical conditions	2015-till date	NIVUS provided equipment's worth several lakhs for SCMS Water Institute for technical teaching, demonstration and training
10	Research collaboration leading to publication of a paper	Technical University Bulgaria	2019	Collaborative research work	2019-2020	Published a paper with collaboration with Technical University Bulgaria



DR. PRAVEENSAL C.J.
PRINCIPAL
SCMS SCHOOL OF ENGINEERING & TECHNOLOGY



Since 1967

HUNGKUANG
University



SCMS

GROUP OF EDUCATIONAL INSTITUTIONS

MEMORANDUM OF UNDERSTANDING

between

Hungkuang University (Taichung, Taiwan R.O.C)

and

SCMS Group of Educational Institutions (Kerala, India)

Hungkuang University, located at Taichung, Taiwan R.O.C. and SCMS Group of Educational Institutions, located at Cochin, Kerala, India wish to develop academic/cultural exchange between the two institutions in education, research and other areas, and agree to formally establish a collaborative relationship with each other. Subject to mutual consent, the provisions of the agreement are as follows:

Article I.

The areas of collaboration include any program offered by either university in which the two institutions believe collaboration is feasible and desirable and which would develop and enhance a mutually beneficial relationship between the two universities.

Article II.

Subject to the approval of the President of each institution and the availability of funding, assistance shall be carried out through any one or more of the following activities or programs as mutually agreed to by both parties:

- i. Student Exchange Program
- ii. Faculty Exchange Program
- iii. Special Short-term Academic Programs
- iv. Staff Development Projects
- v. Joint Research and Activities

Article III.

This cooperation agreement shall become effective as soon as the presidents of both institutions sign it, and will remain in force for a period of five years. This MOU will be automatically renewed on the same terms and conditions for another five years unless either party raises a written notification 6 months prior to the date of expiration. Either party reserves the right to terminate this agreement upon a one-year prior written declaration by the terminating party.

Article IV.

Any amendment to this MOU shall be based on the mutual consent and requires the written approval of the President of each institution that shall be appended hereto. This declaration will become effective with the agreement of both parties.

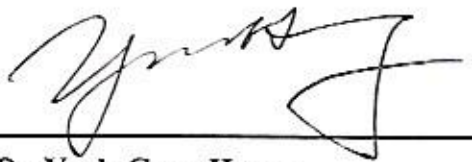

Dr. Yueh-Guey Huang
President
Hungkuang University



Prof. Pramod P. Thevannoor
Vice Chairman
SCMS Group of Educational
Institutions, India

Date: Mar. 22, 2019

Date: 22/03/2014.

MoU signings with International Universities

➤ **HUNG KUANG UNIVERSITY, TAIWAN**

SCMS Group of Educational Institutions signed a Memorandum of Understanding with Hung Kuang University, Taiwan on 22nd March 2019 for academic and research collaboration. Hung Kuang University is one of the top ranked Universities in the field of Health, Biomedical Engineering and Information Systems in Taiwan.



In the meeting held at Hung Kuang University Head Quarters in Taichung, Taiwan, Prof. Pramod P Thevannoor Vice Chairman SCMS Group and Dr. Laura Huang, President Hung Kuang University signed the MoU. During the discussions that followed, Dr. Sunil Jacob, Director SCMS Center for Robotics gave a presentation on the ongoing research projects at SCMS.

Based on the discussions, SCMS would provide necessary technology transfer and support for using the De-addiction electromagnetic coil developed at SCMS Center for Robotics in the ongoing research on bone Osteoporosis at Department of Biomedical Engineering, Hung Kuang University. SCMS would also provide necessary technology and assistance in the development of assistive technologies for the paralyzed persons. Both Institutions also agreed to collaborate on research projects such as IoT enabled flood detection systems and underwater Unmanned Aerial Vehicles. Based on the collaboration, students from SCMS would have an opportunity to do short term internships and Master Degree programs at Hung Kuang University.

Members present at the meeting:

Sitting (From Left): Prof. Sunil Jacob Director-SCMS Center for Robotics, Prof. Pramod P Thevannoor, Vice Chairman SCMS, Dr. Laura Huang, President Hung Kuang University and Dr. Shu Hung-Yee Executive Vice President Hung Kuang University.

Standing (From Left)

Mr. Jeffrey Lin International Relations Advisor Hung Kuang University, Prof. Tiger Tien Head of International Relations at Hung Kuang University, Dr. Varun G Menon, Associate Professor and International Relations-in charge at SCMS, Dr. Yeong-Yuh Xu, Director Department of Computer Science and Information Engineering, Dr. Taipau Chia Associate Professor Department of Safety, Health and Environmental Engineering and Dr. Ming-Tzu Tsai, Director Department of Biomedical Engineering

➤ **SHIMANE UNIVERSITY, JAPAN**

SCMS Group of Educational Institutions signed MoU with Shimane University, Japan on 18/12/2018 at SCMS campus, Kalamassery. As per the agreement, both institutions will collaborate on various areas in research and academics in Management and Engineering education sector. The MoU was signed between Prof. Pramod P Thevannoor, Vice Chairman of SCMS Group and Prof. Yasunano Hattori, President of Shimane University in a function held at SCMS campus in kalamassery. Five Students from SCMS Institutions have already done Internships at Shimane University in last two years. Three students from SCMS School of Engineering and Technology would be traveling to Shimane University in January 2019 for joining the Internship program. Based on the MoU more students from SCMS would be invited to Shimane University for Internships and training programs in subsequent years.

The MoU would also promote student and faculty exchange programs between the institutions. Both institutions would work on possible areas of research collaboration in robotics, environmental engineering, computer security and other engineering disciplines.



The delegation from Shimane University was led by Yasunano Hattori, President of Shimane University. Mr. Kouke Takahashi, International Student Center-in charge and Ms Miki Shimizu, Japanese Language Teacher at Shimane University was the other members of the delegation.

➤ **DAFFODIL INTERNATIONAL UNIVERSITY, BANGLADESH**

MoU signed by Prof. Dr. Yousuf Mahbubul Islam Vice Chancellor Daffodil International University (DIU) and Prof. Pramod, Vice Chairman SCMS. MoU signing was followed by discussions on possible collaborative programs between the two universities. Short term internship opportunities at SCMS for students from DIU was the major topic of discussion.





Varun Menon G <varunmenon@scmsgroup.org>

Arrangement of talk for Hungkuang University

2 messages

國際處李昭妮 <peyton5400@hk.edu.tw>

Mon, May 18, 2020 at 10:34 AM

To: vinodp@scmsgroup.org

Cc: 田其虎國際長 <tigert@hk.edu.tw>, varunmenon@scmsgroup.org, pramod@scmsgroup.org, gopakumars@scmsgroup.org, praveensal@scmsgroup.org, 醫工系蔡明慈主任 <anniemtt@sunrise.hk.edu.tw>, 環安系盧信忠主任 <hclu@sunrise.hk.edu.tw>, 國際處楊蜀瑜秘書 <gracetaiwan@hk.edu.tw>, Fannie Leung <fannie@hk.edu.tw>

Dear Dr. Vinod,

Greetings!

I'm Peyton Lee, a coordinator of Hungkuang University International Office responsible for global collaboration projects.

It is undeniable that education has been hit particularly hard by the COVID-19 pandemic. School closures in countries worldwide, universities switch to online courses and endless of international exchange programs being put on hold.

Under such circumstances, we'd like to grab this opportunity to thank you for agreeing to deliver a webinar to our students and faculty, so that our collaboration gets to continue in a different way. The honor is definitely ours.

For us 27th May 10.30a.m. to 12.00p.m. your time is perfect. We would very much appreciate it if you could kindly send me your CV and topic you'd like to present, I'll then share with our departments. Also, I'll help set up the meeting room and send you the webinar link right after we have it confirmed.

Till I hear from you, take care and be safe!

Best regards,

Peyton Lee 李昭妮

Coordinator, Office of International and Cross-Strait Affairs 國際暨兩岸事務處

Hungkuang University 弘光科技大學

886-4-26318652 ext. 2233

Vinod P <vinodp@scmsgroup.org>

Mon, May 18, 2020 at 11:31 AM

To: 國際處李昭妮 <peyton5400@hk.edu.tw>

Cc: 田其虎國際長 <tigert@hk.edu.tw>, Varun Menon G <varunmenon@scmsgroup.org>, pramod p thevannoor <pramod@scmsgroup.org>, Gopakumar S <gopakumars@scmsgroup.org>, "Dr. Praveensal C.J." <praveensal@scmsgroup.org>, 醫工系蔡明慈主任 <anniemtt@sunrise.hk.edu.tw>, 環安系盧信忠主任 <hclu@sunrise.hk.edu.tw>, 國際處楊蜀瑜秘書 <gracetaiwan@hk.edu.tw>, Fannie Leung <fannie@hk.edu.tw>

Good Morning

Thanks for inviting me to the talk. I am really excited to share my ideas regarding "Machine Learning Approaches for Detecting Malicious Code". In this talk I will discuss the following:

- [1] What is malware?
- [2] State of Art detection methods
- [3] Machine learning approaches for detecting malware
- [4] Attacks on machine learning-based malware scanners
- [5] Countermeasures
- [6] Ongoing Cybersecurity research at SCMS, Kerala, India

You can also suggest if something more needs to be discussed. I will share my CV and photograph by today evening.

Regards

Vinod

[Quoted text hidden]

--

"Be less curious about people and more curious about ideas" --Marie Curie

Dr. Vinod P.

Professor & Head - Department of Computer Science & Engineering

SCMS School of Engineering and Technology

Ernakulam, Kerala, India, Pin code- 683582



Varun Menon G <varunmenon@scmsgroup.org>

Certificate of Appreciation by Hungkuang University

1 message

國際處李昭妮 <peyton5400@hk.edu.tw>
To: "Dr. Varun G Menon" <varunmenon@scmsgroup.org>
Cc: 田其虎國際長 <tigert@hk.edu.tw>

Fri, Jul 31, 2020 at 8:44 AM

Dear Dr. Varun,

Hope this email finds you well.

Attached please find the certificate of appreciation presented by Hungkuang University on your effort and time to deliver the talk on June 15. :-)

In case you need the hard copy, kindly let me know, I'll then post it to you.

Best,

Peyton Lee 李昭妮

Coordinator, Office of International and Cross-Strait Affairs 國際暨兩岸事務處

Hungkuang University 弘光科技大學

886-4-26318652 ext. 2233

 **Dr. Varun G Menon.pdf**
599K



Varun Menon G <varunmenon@scmsgroup.org>

Research Collaboration between SCMS and Hung Kuang University

5 messages

Dr. Varun G Menon <varunmenon@scmsgroup.org>

Fri, Apr 5, 2019 at 6:49 PM

To: anniemtt@sunrise.hk.edu.tw

Cc: Sunil Jacob <suniljacob@scmsgroup.org>, Pramod <pramod@scmsgroup.org>, 國際長田其虎 <tigert@sunrise.hk.edu.tw>, Gopakumar S <gopakumars@scmsgroup.org>, "Dr. Praveensal C.J." <praveensal@scmsgroup.org>, 林敬宗 <lin.jeffrey@hk.edu.tw>, 黃月桂校長 <laura@hk.edu.tw>

Dear Dr. Ming Tzu Tsai,

Hope you are having a wonderful time at Hung Kuang University. We were discussing on possible research collaboration opportunities between the two Institutes. As discussed during our visit, research collaboration on the application of the magnetic coil could be a very good start in this regard.

I am keeping the copy of the email to Dr. Sunil Jacob. Request both of you to take forward the discussion.

Dr. Sunil Jacob, Director, Center for Robotics, Email: suniljacob@scmsgroup.org

Dr. Ming Tzu Tsai, Director, Department of Biomedical Engineering, Email: anniemtt@sunrise.hk.edu.tw

For any further information or help please feel free to contact me. We look forward to start the active partnership between the Institutes at the earliest.

Thanks and Regards,

Dr. Varun G Menon

Associate Professor, Computer Science Engineering

ACM Distinguished Speaker

Guest Editor Journal of Supercomputing (Cyberphysical Systems)

Corporate Relations and International Collaborations-in charge

SCMS School of Engineering and Technology

SCMS Group of Educational Institutions

Karukutty, Ernakulam, Kerala, India - 683 582

Office: +91-484-2450330 Mob: +91-8714504684

Web: <http://www.scmsgroup.org>



SCMS

GROUP OF EDUCATIONAL INSTITUTIONS

弘光醫工系-蔡明慈 Tsai MT <anniemtt@sunrise.hk.edu.tw>

Fri, Apr 12, 2019 at 4:35 PM

To: varunmenon@scmsgroup.org

Cc: Tiger <tigert@hk.edu.tw>, HK1醫工1-陳信介 <hcchen@sunrise.hk.edu.tw>, suniljacob@scmsgroup.org

Dear Prof. Menon,

Thank you for the email and we are delighted and looking forward to the research collaboration between the institutes.

Although I do not have any idea about how to start the collaboration, my colleagues and I would love to discuss if you have any thought or plan.

Sincerely,

MTT

Annie Ming-Tzu Tsai
Associated Professor, Director
Department of Biomedical Engineering
HUNGKUANG UNIVERSITY
1018, Sec. 6, Taiwan Boulevard, Shalu District
Taichung City 43302, TAIWAN

Mobile: 0928-634-434
TEL: 886-4-2631-8652 ext. 4300
FAX: 886-4-2631-3871
E-mail: anniemtt@sunrise.hk.edu.tw
anniemtt@gmail.com

From: Tiger [<mailto:tigert@hk.edu.tw>]
Sent: Tuesday, April 09, 2019 12:43 PM
To: anniemtt@sunrise.hk.edu.tw
Subject: Fwd: Research Collaboration between SCMS and Hung Kuang University

----- Forwarded message -----

From: **Dr. Varun G Menon** <varunmenon@scmsgroup.org>
Date: Fri, Apr 5, 2019 at 21:19
Subject: Research Collaboration between SCMS and Hung Kuang University
To: <anniemtt@sunrise.hk.edu.tw>
CC: Sunil Jacob <suniljacob@scmsgroup.org>, Pramod <pramod@scmsgroup.org>, 國際長田其虎 <tigert@sunrise.hk.edu.tw>, Gopakumar S <gopakumars@scmsgroup.org>, Dr. Praveensal C.J. <praveensal@scmsgroup.org>, 林敬宗 <lin.jeffrey@hk.edu.tw>, 黃月桂校長 <laura@hk.edu.tw>

Dear Dr. Ming Tzu Tsai,

Hope you are having a wonderful time at Hung Kuang University. We were discussing on possible research collaboration opportunities between the two Institutes. As discussed during our visit, research collaboration on the application of the magnetic coil could be a very good start in this regard.

I am keeping the copy of the email to Dr. Sunil Jacob. Request both of you to take forward the discussion.

Dr. Sunil Jacob, Director, Center for Robotics, Email: suniljacob@scmsgroup.org

Dr. Ming Tzu Tsai, Director, Department of Biomedical Engineering, Email: anniemtt@sunrise.hk.edu.tw

For any further information or help please feel free to contact me. We look forward to start the active partnership between the Institutes at the earliest.

Thanks and Regards,

Dr. Varun G Menon

Associate Professor, Computer Science Engineering

ACM Distinguished Speaker

Guest Editor Journal of Supercomputing (Cyberphysical Systems)

Corporate Relations and International Collaborations-in charge

SCMS School of Engineering and Technology

SCMS Group of Educational Institutions

Karukutty, Ernakulam, Kerala, India - 683 582

Office: +91-484-2450330 Mob: +91-8714504684

Web: <http://www.scmsgroup.org>



SCMS
GROUP OF EDUCATIONAL INSTITUTIONS

--

Tiger田其虎

弘光科技大學國際暨兩岸事務處國際長

Dean, Office of International and Cross-Strait Affairs

台灣台中市沙鹿區台灣大道六段1018號

No. 1018, Sec. 6, Taiwan Boulevard, Shalu District, Taichung City 43302, Taiwan (R.O.C.)

tigert@hk.edu.tw

+886-4-22363663 EX 7300

+886-921892821

Sunil Jacob <suniljacob@scmsgroup.org>

Tue, Apr 16, 2019 at 10:41 AM

To: 弘光醫工系-蔡明慈 Tsai MT <anniemtt@sunrise.hk.edu.tw>

Cc: Varun Menon G <varunmenon@scmsgroup.org>, Tiger <tigert@hk.edu.tw>, HK1醫工1-陳信介 <hcchen@sunrise.hk.edu.tw>, Pramod P Thevannoor <pramod@scmsgroup.org>, Gopakumar S <gopakumars@scmsgroup.org>, "Dr. Praveensal C.J." <praveensal@scmsgroup.org>

Dear Annie Ming-Tzu Tsai

Thank you for your mail.

Hope you all are doing well.

As discussed I would like to detail about our project Smart EM coil for the study of Osteoporosis, or porous bone, It is a disease characterized by low bone mass and structural deterioration of bone tissue, leading to bone fragility and an increased risk of fractures of the hip, spine, and wrist. Men as well as women are affected by osteoporosis, a disease that can be prevented and treated.

We can make the smart EM coil for the required value of Tesla which u can use to test and validate the result for the above mentioned cause.

The device is modeled and we are testing it for Rejuvenation of the human cell.
 The technical detail schematic, PCB layout and the device model is attached for your reference.
 After validating the result we can publish our research collaboration in peer reviewed journals.
 The international patent can be filled and the product can be released in the market.
 Thank you Varun Sir for initiating the process.

Regards,
 Dr. Sunil Jacob
 Director SCMS Centre for Robotics
 Professor Electronics and Communication Engineering Department



SCMS School of Engineering & Technology
 Karukutty, Cochin - 683 582
 Kerala
 India

[Quoted text hidden]

--

3 attachments

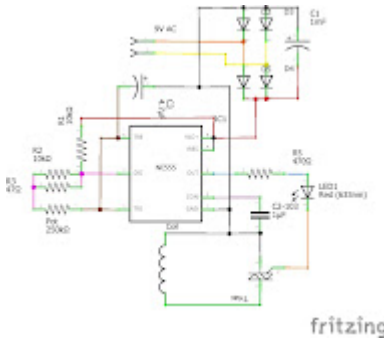

ROC Schematics_Taiwan_schem.jpg
133K



Smart Magnetic coil.jpg
2023K



弘光醫工系-蔡明慈 Tsai MT <anniemtt@sunrise.hk.edu.tw>

Mon, Apr 22, 2019 at 1:23 PM

To: Sunil Jacob <suniljacob@scmsgroup.org>

Cc: Varun Menon G <varunmenon@scmsgroup.org>, Tiger <tigert@hk.edu.tw>, HK1醫工1-陳信介 <hcchen@sunrise.hk.edu.tw>, Pramod P Thevannoor <pramod@scmsgroup.org>, Gopakumar S <gopakumars@scmsgroup.org>, "Dr. Praveensal C.J." <praveensal@scmsgroup.org>

Dear Prof. Jacob,

I hope you are doing well and thank you for your kindness for providing the details and research information to this work.

My previous study was to determine the effect of PEMF with the extremely low frequency (ELF) on osteoblasts and osteoclasts for the inhibition of osteoporosis.

The parameters we used were: 7.5 Hz and 0.13 mT .

I am not sure the magnetic intensity produced by PEMF coil has similar effect to the Helmholtz coils. It need to be further confirmed or tested.

I am very glad that we have did a good start of the research collaboration. To well perform this project, I suggest we could go through it individually. Based on Prof. Jacob's expertise, your team could modify the EMF producer as a "smart EMF," and the in vitro stud could be done in my Lab. Or my colleagues could be joined to this project to develop the EMF producer. We can have further discussion if you have any thought about this project or the way how we are going to do.

Best regards,

MTT

Sunil Jacob <suniljacob@scmsgroup.org> 於 2019年4月16日 週二 下午1:11寫道:

[Quoted text hidden]

--

Best regards,

Tsai MT

Annie Ming-Tzu Tsai
Associated Professor, Director
Department of Biomedical Engineering
HUNGKUANG UNIVERSITY
1018, Sec. 6, Taiwan Boulevard, Shalu District
Taichung City 43302, TAIWAN
TEL: 886-4-2631-8652 ext. 4310 / 4316
FAX: 886-4-2631-3871
E-mail: anniemtt@sunrise.hk.edu.tw
anniemtt@hk.edu.tw

Sunil Jacob <suniljacob@scmsgroup.org>

Wed, Apr 24, 2019 at 12:48 PM

To: 弘光醫工系-蔡明慈 Tsai MT <anniemtt@sunrise.hk.edu.tw>

Cc: Varun Menon G <varunmenon@scmsgroup.org>, Tiger <tigert@hk.edu.tw>, HK1醫工1-陳信介 <hcchen@sunrise.hk.edu.tw>, Pramod P Thevannoor <pramod@scmsgroup.org>, Gopakumar S <gopakumars@scmsgroup.org>, "Dr. Praveensal C.J." <praveensal@scmsgroup.org>

Dear Dr Annie,

Thank you for your mail and hope you all are doing great

Yes definitely we can work in this direction.

We in fact will modify and develop the device for variable duty cycle.

It will work for variable frequency from 0Hz to 50 Hz.

The advantage is that we can study the effect at different frequencies.

The coil for different turns ratio can be designed.

Regarding Helmholtz coil generating PEMF.

I got a reference link

https://www.drjohn1.com/wp-content/uploads/2016/11/018_PERIODONTITIS_jbpe-4-83.pdf

Please go thru it. We can easily model it depending on the variable turn ratio, frequency and the distance between the coil.

Yes dear Annie you can definitely test and validate the device in your lab.

While developing the coil you can connect me with your colleagues who would like to work in this direction.

So I am on the design of the smart PEMF coil for variable frequency and Tesla. In July when u will be at SCMS with your team

I will demonstrate the same with your mentioned specification.

Thank you for all your valuable inputs

It was great we feel the collaboration will work.

Thank you all

[Quoted text hidden]

--

[Quoted text hidden]

弘光科技大學
HUNGKUANG
University

Certificate of Appreciation

This is presented to

DR. Varun G Menon

For imparting his valuable wisdom and expertise as a speaker in a

webinar entitled,

“COVID-19 Impact and Opportunities for Students”

Held on June 15, 2020.

校長 黃月桂

President

Yueh Guey Huang

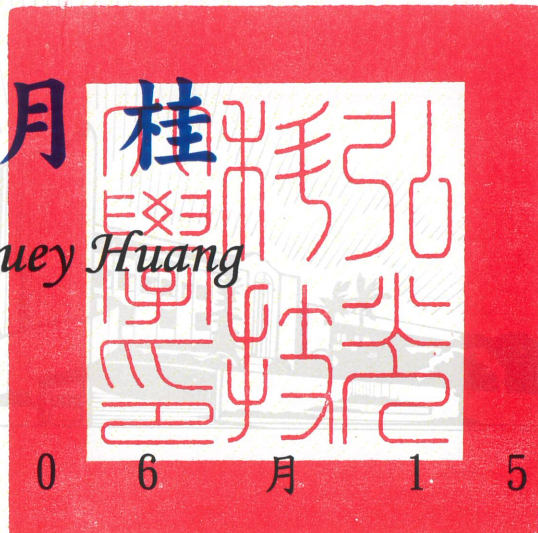

2 0 2 0 年 0 6 月 1 5 日

**AGREEMENT OF COOPERATION
BETWEEN
SCMS
AND
SHIMANE UNIVERSITY**

SCMS, INDIA and Shimane University, JAPAN herewith agree on the following:

1. SCMS and Shimane University will try to cooperate in the spirit of mutual understanding to establish close friendly relations.
2. SCMS and Shimane University will promote the exchange of students, faculty, research, education and academic culture. The details necessary to promote these exchanges will be worked out separately.
3. Through the above activities, SCMS and Shimane University endeavor to improve the educational and academic cultures of both countries, while at the same time promoting greater friendship and contributing to international understanding, goodwill, and peace.
4. This Agreement shall take effect upon the date of the signatures of the Vice Chairman of SCMS and the President of Shimane University, and shall remain in effect for five years from the date of the signatures. For the renewal of this Agreement, SCMS and Shimane University shall enter into negotiations within six months of its expiration.
5. This Agreement may be pre-terminated upon written notice to the other party without prejudice to the completion of any existing exchange and joint program.
6. This Agreement is to be executed in English and each party shall retain a copy.

(Signature)



Pramod Prathapachandran Thevannoor
Vice Chairman
SCMS



Yasunao Hattori
President
Shimane University

Date 18/12/2018

Date 18/12/2018

**A SUPPLEMENTARY AGREEMENT FOR STUDENT EXCHANGE
BETWEEN
SCMS
AND
SHIMANE UNIVERSITY**

SCMS, INDIA and Shimane University, JAPAN herewith agree to the following provision of cooperation on the basis of article 2 of the Principal Agreement for the purpose of promoting student exchange between the two parties.

(Exemption of the Tuition of Students)

1. SCMS and Shimane University shall waive the examination fee, the entrance fee and the tuition of the students who are accepted on the basis of this Supplementary Agreement.

(Exchange Student Number and Period of Exchange)

2. On the basis of the above provision 1, SCMS and Shimane University may send up to two students each year, making an effort to balance the number of students.
3. SCMS and Shimane University shall send students to the other party for a period of six months or no more than one full academic year at the beginning of a semester of the host party.

(Selection of Students)

4. SCMS and Shimane University shall take reasonable care to ensure the students to be recommended are capable of having sufficient knowledge in their academic fields and language ability necessary to study at the host party.

(Student Status)

5. SCMS and Shimane University shall allow students to be enrolled as non-degree students (Special Auditing Students or Special Research Students).

(Credits)

6. University credits earned at the host party may be honored by the student's home party.

(Financing)

7. Travel expenses, living expenses, books and supplies, and all other personal necessary expenses are the responsibility of individual students. Exchange students will be required to purchase health insurance valid in the host country and insurance for accidents especially designed for foreign students before their travel to the host country.

(Terms of Supplementary Agreement)

8. This Supplementary Agreement shall come into effect upon the latter date of the signatures below and shall remain in effect for five years on the condition that any amendments in that period must be agreed upon in writing by SCMS and Shimane University.

(Extension of Supplementary Agreement)

9. For the renewal of this Supplementary Agreement, SCMS and Shimane University shall enter into negotiations within six months of its expiration.

(Agreement Documents)

10. This Supplementary Agreement is executed in English and each party shall retain a copy.

(Signature)



Pramod Prathapachandran Thevannoor
Vice Chairman
SCMS

Date _____



Yasunao Hattori
President
Shimane University

Date 18/12/2018



Varun Menon G <varunmenon@scmsgroup.org>

Regarding the renewal of Agreement

15 messages

国際課国際連携G <ied-koryu@office.shimane-u.ac.jp>
To: "Dr. Varun G Menon" <varunmenon@scmsgroup.org>

Wed, Sep 13, 2023 at 8:23 AM

Dear Dr. Varun G Menon,
International Relations
SCMS School of Engineering and Technology,

Warmest greetings from Shimane University, Japan!

My name is KITAO Chiaki, an administrative staff of the International Division at Shimane University, Japan. I am responsible for managing our partnerships with other universities. Taking this opportunity, I would like to express our sincere appreciation for your valuable cooperation in maintaining our academic relationship over the years. I am pleased to inform you that the Academic Agreement between SCMS and Shimane University will expire in December, and it is time to discuss the renewal of the agreement. Shimane University is willing to continue our partnership for another 5 years, and we would be grateful if you could let us know your intentions regarding this matter.

Attached to this email, you will find the draft of the AOC and SEA for review.

Please feel free to contact me if you have any questions or concerns. We sincerely hope to receive your positive response soon.

Sincerely yours,

Chiaki,

--

KITAO Chiaki (Ms)
International Div.
SHIMANE UNIVERSITY
1060 Nishikawatsu, Matsue, Shimane
690-8504, JAPAN
tel:+81-(0)852-32-9735
fax:+81-(0)852-32-6481
[e-mail:ied-koryu@office.shimane-u.ac.jp](mailto:ied-koryu@office.shimane-u.ac.jp)

2 attachments

 **Draft_AOC_SCMS_SU.doc**
48K

 **Draft_SEA_SCMS_SU.doc**
35K

Dr. Varun G Menon <varunmenon@scmsgroup.org>
To: PRINCIPAL SSET <principalsset@scmsgroup.org>

Mon, Sep 18, 2023 at 11:26 AM

Ma'am,
Please find the request for renewal of collaboration from Shimane University. Looking forward to your approval

[Quoted text hidden]

--

Thanks and Regards,

Dr. Varun G Menon, Senior Member IEEE
Professor and Head
Department of Computer Science and Engineering
International Collaborations -in charge
SCMS School of Engineering and Technology
SCMS Group of Educational Institutions
Kerala, India - 683 576, Mob: +91 8714504684

Associate Editor - Physical Communications Journal, Elsevier
Series Editor - IEEE Transactions on Intelligent Transportation Systems
Series Editor - IEEE Communications Standards Magazine
Technical Editor - Computer Communications Journal, Elsevier
Associate Editor - Alexandria Engineering Journal, Elsevier
Associate Editor - IET Networks
Editorial Member - IEEE Future Directions Newsletter

2 attachments

 **Draft_AOC_SCMS_SU.doc**
48K

 **Draft_SEA_SCMS_SU.doc**
35K

Dr. Varun G Menon <varunmenon@scmsgroup.org>
To: 国際課国際連携G <ied-koryu@office.shimane-u.ac.jp>
Cc: PRINCIPAL SSET <principalsset@scmsgroup.org>

Mon, Sep 18, 2023 at 11:27 AM

Dear Ms. KITAO Chiaki,

Thank you very much for the email. I will get back to you as soon as possible.

Regards

[Quoted text hidden]

[Quoted text hidden]

PRINCIPAL SSET <principalsset@scmsgroup.org>
To: "Dr. Varun G Menon" <varunmenon@scmsgroup.org>

Mon, Sep 18, 2023 at 1:33 PM

Noted. Will revert. Let me know the period (from and to) of last agreement.

Regards,

Dr. Anitha G. Pillai |

Principal



SCMS
School of Engineering & Technology

SCMS School of Engineering & Technology (SSET)
Vidya Nagar, Palissery, Karukutty - 683 576, Kerala, India.
Tel: 91-484-2882901
Mob: 9497775295
e-mail: principalsset@scmsgroup.org
anithagpillai@scmsgroup.org

[Quoted text hidden]

Dr. Varun G Menon <varunmenon@scmsgroup.org>
To: PRINCIPAL SSET <principalsset@scmsgroup.org>

Mon, Sep 18, 2023 at 1:40 PM

Ma'am,
Please find the attached signed MoU(previous).

Regards

[Quoted text hidden]



Shimane University - Agreement of Cooperation.pdf
507K

PRINCIPAL SSET <principalsset@scmsgroup.org>
To: "Dr. Varun G Menon" <varunmenon@scmsgroup.org>

Mon, Sep 18, 2023 at 1:51 PM

Noted
Regards,

Dr. Anitha G. Pillai |

Principal



SCMS

School of Engineering & Technology

SCMS School of Engineering & Technology (SSET)
Vidya Nagar, Palissery, Karukutty - 683 576, Kerala, India.
Tel: 91-484-2882901
Mob: 9497775295
e-mail: principalsset@scmsgroup.org
anithagpillai@scmsgroup.org

[Quoted text hidden]

PRINCIPAL SSET <principalsset@scmsgroup.org>
To: "Dr. Varun G Menon" <varunmenon@scmsgroup.org>, HOD Computer Science Engineering Department <hodcssset@scmsgroup.org>, HOD Artificial Intelligence and Data Science <hoddsaisset@scmsgroup.org>

Tue, Sep 19, 2023 at 9:50 AM

Do needful to get the new agreement signed.

Regards,

Dr. Anitha G. Pillai |

Principal



SCMS

School of Engineering & Technology

SCMS School of Engineering & Technology (SSET)
Vidya Nagar, Palissery, Karukutty - 683 576, Kerala, India.
Tel: 91-484-2882901
Mob: 9497775295
e-mail: principalsset@scmsgroup.org
anithagpillai@scmsgroup.org

[Quoted text hidden]

Dr. Varun G Menon <varunmenon@scmsgroup.org>
To: PRINCIPAL SSET <principalsset@scmsgroup.org>
Cc: HOD Computer Science Engineering Department <hodcssset@scmsgroup.org>, HOD Artificial Intelligence and Data Science <hoddsaisset@scmsgroup.org>

Tue, Sep 19, 2023 at 10:00 AM

Noted ma'am.
Will do the needful and update you

[Quoted text hidden]

Dr. Varun G Menon <varunmenon@scmsgroup.org>
To: 国際課国際連携G <ied-koryu@office.shimane-u.ac.jp>

Tue, Sep 19, 2023 at 1:31 PM

Cc: PRINCIPAL SSET <principalsset@scmsgroup.org>, HOD Computer Science Engineering Department <hodcssset@scmsgroup.org>

Dear Ms. KIATO Chiaki,

We have gone through the draft AOC and are happy to proceed with the collaboration for the next 5 years. Please let me know the next steps required.

Regards,
Varun

[Quoted text hidden]

[Quoted text hidden]

国際課国際連携G <ied-koryu@office.shimane-u.ac.jp>

Wed, Sep 20, 2023 at 6:42 AM

To: "Dr. Varun G Menon" <varunmenon@scmsgroup.org>

Cc: PRINCIPAL SSET <principalsset@scmsgroup.org>, HOD Computer Science Engineering Department <hodcssset@scmsgroup.org>

Dear Dr. Varun G Menon,

Thank you for your response. We are pleased to know that SCMS has agreed to update our Agreement.

However, we would like to inform you that we need to obtain approval from our university committee before renewing the agreement. Once we receive the approval, we can proceed to the signing step.

Therefore, we kindly request a few months to complete our internal process. We will keep you updated on any progress made.

We apologize for any inconvenience caused and appreciate your patience and understanding.

Thank you and have a great day!

Sincerely,

Chiaki,

KITAO Chiaki,
International Div.
Shimane University

On 2023/09/19 17:01, Dr. Varun G Menon wrote:

Dear Ms. KIATO Chiaki,

We have gone through the draft AOC and are happy to proceed with the collaboration for the next 5 years. Please let me know the next steps required.

Regards,
Varun

[Quoted text hidden]

<mailto:e-mail%3Aied-koryu@office.shimane-u.ac.jp>

--

Thanks and Regards,

*

*

*Dr. Varun G Menon, */Senior //Member IEEE/

[Quoted text hidden]

Dr. Varun G Menon <varunmenon@scmsgroup.org>

Wed, Sep 20, 2023 at 10:45 AM

To: 国際課国際連携G <ied-koryu@office.shimane-u.ac.jp>
Cc: PRINCIPAL SSET <principalsset@scmsgroup.org>, HOD Computer Science Engineering Department <hodcssset@scmsgroup.org>

Dear Ms. KITAO Chiaki,

Thank you for the reply. Looking forward to further updates from you.

Regards,
Varun

[Quoted text hidden]

--

Thanks and Regards,

Dr. Varun G Menon, Senior Member IEEE

[Quoted text hidden]

国際課国際連携G <ied-koryu@office.shimane-u.ac.jp> Thu, Dec 7, 2023 at 8:16 AM
To: "Dr. Varun G Menon" <varunmenon@scmsgroup.org>
Cc: PRINCIPAL SSET <principalsset@scmsgroup.org>, HOD Computer Science Engineering Department <hodcssset@scmsgroup.org>

Dear Dr. Varun G Menon,

Greetings from Shimane University!

I am sorry to have kept you waiting so long, but I am pleased to inform you that we have got approval from the internal meeting to renew our agreement, and now we are ready to sign.

I am arranging to have our president signature first, and would like to send the signed documents to you for your president's signature.

Could you please let me know your mailing address?

Thank you for your kind patience.
Looking forward to hearing from you.

Sincerely,

Chiaki,

KITAO Chiaki,
International Div.
Shimane University

[Quoted text hidden]

Dr. Varun G Menon <varunmenon@scmsgroup.org> Fri, Dec 8, 2023 at 3:26 PM
To: 国際課国際連携G <ied-koryu@office.shimane-u.ac.jp>
Cc: PRINCIPAL SSET <principalsset@scmsgroup.org>

Dear Chiaki,

Thank you for sharing the wonderful news. Please find the mailing address below. If possible, please send me the document tracking ID once you post it.

Dr. Varun G Menon,
Deputy Dean (Research & Development)
Professor - Computer Science and Engineering
International Collaborations -in charge
SCMS School of Engineering and Technology, Kerala,
India - 683 576

MOBILE: +91 8714504684

Regards,
Varun

[Quoted text hidden]

--

Thanks and Regards,

Dr. Varun G Menon, *Senior Member IEEE*
Deputy Dean (Research & Development)
Professor - Computer Science and Engineering
International Collaborations -in charge
SCMS School of Engineering and Technology
SCMS Group of Educational Institutions, Kerala, India - 683 576

Area Editor - Physical Communications Journal, Elsevier

[Quoted text hidden]

国際課国際連携G <ied-koryu@office.shimane-u.ac.jp>
To: "Dr. Varun G Menon" <varunmenon@scmsgroup.org>
Cc: PRINCIPAL SSET <principalsset@scmsgroup.org>

Tue, Dec 12, 2023 at 5:46 AM

Dear Dr. Varun G Menon,

Thank you for your reply.

I will post the signed agreement via EMS today and it's tracking number is "EN289370901JP".

Once your president sign the agreement, I would like to ask you to send one copy back to us the following address for our record.

KITAO CHIAKI
International Division, Shimane University
1060 Nishikawatsu-cho, Matsue, Shimane 690-8504, JAPAN
TEL:+81-852-32-9735

Thank you for your cooperation.

Sincerely,

Chiaki,

KITAO Chiaki
International Div.
Shimane University

On 2023/12/08 18:56, Dr. Varun G Menon wrote:

Dear Chiaki,

Thank you for sharing the wonderful news. Please find the mailing address below. If possible, please send me the document tracking ID once you post it.

*Dr. Varun G Menon, *
Deputy Dean (Research & Development)
Professor - Computer Science and Engineering
International Collaborations -in charge
SCMS School of Engineering and Technology, Kerala,
India - 683 576

MOBILE: +91 8714504684

*

*

Regards,
Varun

[Quoted text hidden]

>> <<mailto:ied-koryu@office.shimane-u.ac.jp>>

[Quoted text hidden]

>> <<mailto:e-mail%3Aied-koryu@office.shimane-u.ac.jp>>

<<mailto:e-mail%253Aied-koryu@office.shimane-u.ac.jp>>>

[Quoted text hidden]

[Quoted text hidden]

Dr. Varun G Menon <varunmenon@scmsgroup.org>

Tue, Dec 12, 2023 at 5:48 AM

To: 国際課国際連携G <ied-koryu@office.shimane-u.ac.jp>

Cc: PRINCIPAL SSET <principalsset@scmsgroup.org>

Dear Chiaki,

Thank you for the EMS details. Once received I will update you.

Regards

[Quoted text hidden]

--

Thanks and Regards,

Dr. Varun G Menon, *Senior Member IEEE*

[Quoted text hidden]



Varun Menon G <varunmenon@scmsgroup.org>

Invitation of Applications from SCMS for MATSUE INTERNSHIP PROGRAM - JAN 28 - FEB 10 , 2024 in Matsue city, JAPAN - Deadline: MAY 31, 2023

18 messages

Asa Kerala <asanipponkerala@gmail.com>

Fri, Apr 28, 2023 at 10:54 PM

To: Varun Menon SCMS <varunmenon@scmsgroup.org>

Cc: Gopakumar S <meenagopan1984@gmail.com>, T J Thomas <tjthomas.6125@gmail.com>, Subhash T J <tjsubhash@gmail.com>, bebymathew@gmail.com, MADHU S NAIR <cmd@cochinshipyard.com>, Edgar Morris <edgarfmorris@gmail.com>, Hudson Peter <hudsonpeter4@gmail.com>

Dear Dr. Varun G Menon,

Greetings.

This has reference to the telephonic discussion we had last week on the invitation of Applications of candidates for Matsue Internship Program in Japan this year.

As you are aware, the formal name of the Program is Lake Nakaumi, Lake Shinji & Mt. Daisen Region Indian Human Resources Intake and Business Alliance Promotion Project. This Program is organized by Matsue City Authorities in association with AOTS, Tokyo and ASA Kerala. This time the Program will be in February 2024.

As usual, we have received the Program Announcement for this year from Matsue City Authorities. They are inviting the 3rd and 4th year Engineering students of 2023-24.

The following documents of the Program are attached.

1. Application Guidelines
2. Program Flyer
3. Application form

You may please note that as usual, they are inviting only a total of 6 (SIX) students from three Colleges, for this Internship. Further, they have included non-IT Branches of Engineering also.

This internship program will provide the participants an opportunity to get selected for employment in Japan.

Matsue City Authorities have separately indicated that they mostly prefer Pre-final year students, as the students have more time to plan and will be more inclined to accept opportunities in Japan.

Kindly make your recommendations as follows.

1. Four Applicants from Pre-Final Year students of IT, Computer Science and other Branches of Engineering
2. Two Applicants from Final Year students. Please select them based on their strong intention to take employment in Japan.

The Applicants should meet the qualifications specified in Para 3 of the Application Guidelines.

As instructed in Para 11 of the Guidelines, please send us the filled up Application forms both in EXCEL Format and PDF files along with scanned copies of the supporting documents. Also please attach copies of their passports.

Please take care to write the **Name of the Applicant as written in the Passport.**

APPLICATION DEADLINE: MAY 31, 2023 at Nippon Kerala Centre

The Candidates may have to appear for an Interview at Nippon Kerala Centre after submission. The Date of the Interview shall be informed later. We will be selecting two students from among them.

We will forward the Applications of the selected students to the Matsue city Authorities in Japan by the first week of June 2023.

Matsue will announce the names of the approved candidates by end June 2023.

The approved candidates will have to attend Online Japanese Language classes for 10 hours per week from July 2023 to January 2024.

Internship in Japan will be for a period of two weeks from JANUARY 28 to FEB 10, 2024.

The Participants on successful completion of the Internship, are eligible to become Associate Members of our Alumni Society.



Hope you will kindly do the needful. In case you need any further clarification, you may please contact my colleague in ASA Kerala, Mr. Hudson Peter (Mob: 9447169399).

Eagerly await your timely response.

Thanks and regards

Sincerely yours
Gopakumar S
President
ASA Kerala
Nippon Kerala Centre
KINFRA Hi-Tech Park
HMT Colony P.O.
Kalamassery-683503
Kerala, India
<http://www.asakerala.org/>
asanipponkerala@gmail.com
+91 75580 81097

3 attachments

-  **Application Guidelines - Matsue Internship-'23-'24.pdf**
423K
-  **Matsue Program Flyer - '23-'24.pdf**
955K
-  **Application form- Matsue Internship-'23-'24.xlsx**
152K

Dr. Varun G Menon <varunmenon@scmsgroup.org>

Tue, May 2, 2023 at 11:09 AM

To: Asa Kerala <asanipponkerala@gmail.com>

Cc: Gopakumar S <meenagopan1984@gmail.com>, T J Thomas <tjthomas.6125@gmail.com>, Subhash T J <tjsubhash@gmail.com>, Beby Mathew <bebymathew@gmail.com>, MADHU S NAIR <cmd@cochinshipyard.com>, Edgar Morris <edgarfmorris@gmail.com>, Hudson Peter <hudsonpeter4@gmail.com>

Dear Sir,

Thank you very much for the information. We will shortlist the students and update you at the earliest.
Thank you once again for the collaboration with SCMS.

Regards,
Varun

[Quoted text hidden]

--

Thanks and Regards,

Dr. Varun G Menon, *Senior Member IEEE*
Professor and Head

Department of Computer Science and Engineering
International Collaborations -in charge
SCMS School of Engineering and Technology
SCMS Group of Educational Institutions
Kerala, India - 683 576, Mob: +91 8714504684

Associate Editor - Physical Communications Journal, Elsevier
Series Editor - IEEE Transactions on Intelligent Transportation Systems
Series Editor - IEEE Communications Standards Magazine
Technical Editor - Computer Communications Journal, Elsevier
Associate Editor - Alexandria Engineering Journal, Elsevier
Associate Editor - IET Networks
Editorial Member - IEEE Future Directions Newsletter

Dr. Varun G Menon <varunmenon@scmsgroup.org>
To: PRINCIPAL SSET <principalsset@scmsgroup.org>

Tue, May 2, 2023 at 11:22 AM

Ma'am,
For your information.
[Quoted text hidden]

PRINCIPAL SSET <principalsset@scmsgroup.org>
To: "Dr. Varun G Menon" <varunmenon@scmsgroup.org>

Tue, May 2, 2023 at 11:23 AM

Noted
Regards,

Dr. Anitha G. Pillai |
Principal



SCMS

School of Engineering & Technology

SCMS School of Engineering & Technology (SSET)
Vidya Nagar, Palissery, Karukutty - 683 576, Kerala, India.
Tel: 91-484-2882901
Mob: 9497775295 | 7034780073
e-mail: principalsset@scmsgroup.org
anithagpillai@scmsgroup.org

[Quoted text hidden]

Mail Delivery Subsystem <mailer-daemon@googlemail.com>
To: varunmenon@scmsgroup.org

Wed, May 3, 2023 at 1:54 PM



Delivery incomplete

There was a temporary problem delivering your message to **cmd@cochinshipyard.com**. Gmail will retry for 45 more hours. You'll be notified if the delivery fails permanently.

[LEARN MORE](#)

The response was:

The recipient server did not accept our requests to connect. Learn more at <https://support.google.com/mail/answer/7720> [cochinshipyard.com 162.215.226.3: timed out]

Final-Recipient: rfc822; cmd@cochinshipyard.com

Action: delayed

Status: 4.4.1

Diagnostic-Code: smtp; The recipient server did not accept our requests to connect. Learn more at <https://support.google.com/mail/answer/7720>

[cochinshipyard.com 162.215.226.3: timed out]

Last-Attempt-Date: Wed, 03 May 2023 01:24:37 -0700 (PDT)

Will-Retry-Until: Thu, 04 May 2023 22:39:58 -0700 (PDT)

----- Forwarded message -----

From: "Dr. Varun G Menon" <varunmenon@scmsgroup.org>

To: Asa Kerala <asanipponkerala@gmail.com>

Cc: Gopakumar S <meenagopan1984@gmail.com>, T J Thomas <tjthomas.6125@gmail.com>, Subhash T J <tjsubhash@gmail.com>, Beby Mathew <bebymathew@gmail.com>, MADHU S NAIR <cmd@cochinshipyard.com>, Edgar Morris <edgarfmorris@gmail.com>, Hudson Peter <hudsonpeter4@gmail.com>

Bcc:

Date: Tue, 2 May 2023 11:09:46 +0530

Subject: Re: Invitation of Applications from SCMS for MATSUE INTERNSHIP PROGRAM - JAN 28 - FEB 10 , 2024 in Matsue city, JAPAN - Deadline: MAY 31, 2023

----- Message truncated -----

Mail Delivery Subsystem <mailer-daemon@googlemail.com>

Thu, May 4, 2023 at 3:26 PM

To: varunmenon@scmsgroup.org



Delivery incomplete

There was a temporary problem delivering your message to cmd@cochinshipyard.com. Gmail will retry for 19 more hours. You'll be notified if the delivery fails permanently.

[LEARN MORE](#)

The response was:

The recipient server did not accept our requests to connect. Learn more at <https://support.google.com/mail/answer/7720> [cochinshipyard.com 162.215.226.3: timed out]

Final-Recipient: rfc822; cmd@cochinshipyard.com

Action: delayed

Status: 4.4.1

Diagnostic-Code: smtp; The recipient server did not accept our requests to connect. Learn more at <https://support.google.com/mail/answer/7720>

[[cochinshipyard.com](https://support.google.com/mail/answer/7720) 162.215.226.3: timed out]

Last-Attempt-Date: Thu, 04 May 2023 02:56:49 -0700 (PDT)

Will-Retry-Until: Thu, 04 May 2023 22:39:58 -0700 (PDT)

----- Forwarded message -----

From: "Dr. Varun G Menon" <varunmenon@scmsgroup.org>

To: Asa Kerala <asanipponkerala@gmail.com>

Cc: Gopakumar S <meenagopan1984@gmail.com>, T J Thomas <tjthomas.6125@gmail.com>, Subhash T J <tjsubhash@gmail.com>, Beby Mathew <bebymathew@gmail.com>, MADHU S NAIR <cmd@cochinshipyard.com>, Edgar Morris <edgarfmorris@gmail.com>, Hudson Peter <hudsonpeter4@gmail.com>

Bcc:

Date: Tue, 2 May 2023 11:09:46 +0530

Subject: Re: Invitation of Applications from SCMS for MATSUE INTERNSHIP PROGRAM - JAN 28 - FEB 10 , 2024 in Matsue city, JAPAN - Deadline: MAY 31, 2023

----- Message truncated -----

Mail Delivery Subsystem <mailer-daemon@googlemail.com>

Fri, May 5, 2023 at 12:28 PM

To: varunmenon@scmsgroup.org



Message not delivered

There was a problem delivering your message to **cmd@cochinshipyard.com**. See the technical details below.

[LEARN MORE](#)

The response was:

The recipient server did not accept our requests to connect. Learn more at <https://support.google.com/mail/answer/7720> [[cochinshipyard.com](https://support.google.com/mail/answer/7720) 162.215.226.3: timed out]

Final-Recipient: rfc822; cmd@cochinshipyard.com

Action: failed

Status: 4.4.1

Diagnostic-Code: smtp; The recipient server did not accept our requests to connect. Learn more at <https://support.google.com/mail/answer/7720>

[[cochinshipyard.com](https://support.google.com/mail/answer/7720) 162.215.226.3: timed out]

Last-Attempt-Date: Thu, 04 May 2023 23:58:32 -0700 (PDT)

----- Forwarded message -----

From: "Dr. Varun G Menon" <varunmenon@scmsgroup.org>

To: Asa Kerala <asanipponkerala@gmail.com>

Cc: Gopakumar S <meenagopan1984@gmail.com>, T J Thomas <tjthomas.6125@gmail.com>, Subhash T J <tjsubhash@gmail.com>, Beby Mathew <bebymathew@gmail.com>, MADHU S NAIR <cmd@cochinshipyard.com>, Edgar Morris <edgarfmorris@gmail.com>, Hudson Peter <hudsonpeter4@gmail.com>

Bcc:

Date: Tue, 2 May 2023 11:09:46 +0530

Subject: Re: Invitation of Applications from SCMS for MATSUE INTERNSHIP PROGRAM - JAN 28 - FEB 10 , 2024 in

Matsue city, JAPAN - Deadline: MAY 31, 2023

----- Message truncated -----

Dr. Varun G Menon <varunmenon@scmsgroup.org>

Fri, May 26, 2023 at 1:20 PM

To: Asa Kerala <asanipponkerala@gmail.com>

Cc: Gopakumar S <meenagopan1984@gmail.com>, T J Thomas <tjthomas.6125@gmail.com>, Subhash T J <tjsubhash@gmail.com>, Beby Mathew <bebymathew@gmail.com>, MADHU S NAIR <cmd@cochinshipyard.com>, Edgar Morris <edgarfmorris@gmail.com>, Hudson Peter <hudsonpeter4@gmail.com>, PRINCIPAL SSET <principalsset@scmsgroup.org>

Dear Sir,

Please find the attached application forms and certificates of the six shortlisted students from SCMS School of Engineering and Technology for the Matsue internship program. Mr. Alan Varghese has applied for the passport today. The passport copies of all others have been attached. Please let me know any further information received.

1	Meenakshy R Nambiar	Semester 6 (CSE)
2	Alan Varghese Paul	Semester 6 (CSE)
3	Gasteena Laurianda Pess	Semester 4 (CSE)
4	Akash T S	Semester 4 (CSE)
5	Claris Isidore	Semester 4 (CSE)
6	Aina Arun	Semester 4 (CSE)

Google Drive Link of documents

 [SCMS_Students Application Forms.rar](#)

Thanks and Regards,
Varun

On Fri, Apr 28, 2023 at 10:55 PM Asa Kerala <asanipponkerala@gmail.com> wrote:

[Quoted text hidden]

[Quoted text hidden]

Mail Delivery Subsystem <mailer-daemon@googlemail.com>

Sat, May 27, 2023 at 1:30 PM

To: varunmenon@scmsgroup.org



Delivery incomplete

There was a temporary problem delivering your message to **cmd@cochinshipyard.com**. Gmail will retry for 47 more hours. You'll be notified if the delivery fails permanently.

[LEARN MORE](#)

The response was:

The recipient server did not accept our requests to connect. Learn more at <https://support.google.com/mail/answer/7720> [cochinshipyard.com 162.215.226.3: timed out]

Final-Recipient: rfc822; cmd@cochinshipyard.com

Action: delayed

Status: 4.4.1

Diagnostic-Code: smtp; The recipient server did not accept our requests to connect. Learn more at <https://support.google.com/mail/answer/7720>

[[cochinshipyard.com](mailto:cmd@cochinshipyard.com) 162.215.226.3: timed out]

Last-Attempt-Date: Sat, 27 May 2023 01:00:19 -0700 (PDT)

Will-Retry-Until: Mon, 29 May 2023 00:50:46 -0700 (PDT)

----- Forwarded message -----

From: "Dr. Varun G Menon" <varunmenon@scmsgroup.org>

To: Asa Kerala <asanipponkerala@gmail.com>

Cc: Gopakumar S <meenagopan1984@gmail.com>, T J Thomas <tjthomas.6125@gmail.com>, Subhash T J <tjsubhash@gmail.com>, Beby Mathew <bebymathew@gmail.com>, MADHU S NAIR <cmd@cochinshipyard.com>, Edgar Morris <edgarfmorris@gmail.com>, Hudson Peter <HUDSONPETER4@gmail.com>, PRINCIPAL SSET <principalssset@scmsgroup.org>

Bcc:

Date: Fri, 26 May 2023 13:20:34 +0530

Subject: Re: Invitation of Applications from SCMS for MATSUE INTERNSHIP PROGRAM - JAN 28 - FEB 10 , 2024 in Matsue city, JAPAN - Deadline: MAY 31, 2023

----- Message truncated -----

Mail Delivery Subsystem <mailer-daemon@googlemail.com>

Sun, May 28, 2023 at 3:49 PM

To: varunmenon@scmsgroup.org



Delivery incomplete

There was a temporary problem delivering your message to cmd@cochinshipyard.com. Gmail will retry for 21 more hours. You'll be notified if the delivery fails permanently.

[LEARN MORE](#)

The response was:

The recipient server did not accept our requests to connect. Learn more at <https://support.google.com/mail/answer/7720> [[cochinshipyard.com](mailto:cmd@cochinshipyard.com) 162.215.226.3: timed out]

Final-Recipient: rfc822; cmd@cochinshipyard.com

Action: delayed

Status: 4.4.1

Diagnostic-Code: smtp; The recipient server did not accept our requests to connect. Learn more at <https://support.google.com/mail/answer/7720>

[[cochinshipyard.com](mailto:cmd@cochinshipyard.com) 162.215.226.3: timed out]

Last-Attempt-Date: Sun, 28 May 2023 03:19:23 -0700 (PDT)

Will-Retry-Until: Mon, 29 May 2023 00:50:46 -0700 (PDT)

----- Forwarded message -----

From: "Dr. Varun G Menon" <varunmenon@scmsgroup.org>

To: Asa Kerala <asanipponkerala@gmail.com>

Cc: Gopakumar S <meenagopan1984@gmail.com>, T J Thomas <tjthomas.6125@gmail.com>, Subhash T J

<tjsubhash@gmail.com>, Beby Mathew <bebymathew@gmail.com>, MADHU S NAIR <cmd@cochinshipyard.com>, Edgar Morris <edgarfmorris@gmail.com>, Hudson Peter <hudsonpeter4@gmail.com>, PRINCIPAL SSET <principalsset@scmsgroup.org>

Bcc:

Date: Fri, 26 May 2023 13:20:34 +0530

Subject: Re: Invitation of Applications from SCMS for MATSUE INTERNSHIP PROGRAM - JAN 28 - FEB 10 , 2024 in Matsue city, JAPAN - Deadline: MAY 31, 2023

----- Message truncated -----

Mail Delivery Subsystem <mailer-daemon@googlemail.com>

Mon, May 29, 2023 at 1:27 PM

To: varunmenon@scmsgroup.org



Message not delivered

There was a problem delivering your message to **cmd@cochinshipyard.com**. See the technical details below.

[LEARN MORE](#)

The response was:

The recipient server did not accept our requests to connect. Learn more at <https://support.google.com/mail/answer/7720> [cochinshipyard.com 162.215.226.3: timed out]

Final-Recipient: rfc822; cmd@cochinshipyard.com

Action: failed

Status: 4.4.1

Diagnostic-Code: smtp; The recipient server did not accept our requests to connect. Learn more at <https://support.google.com/mail/answer/7720>

[cochinshipyard.com 162.215.226.3: timed out]

Last-Attempt-Date: Mon, 29 May 2023 00:57:14 -0700 (PDT)

----- Forwarded message -----

From: "Dr. Varun G Menon" <varunmenon@scmsgroup.org>

To: Asa Kerala <asanipponkerala@gmail.com>

Cc: Gopakumar S <meenagopan1984@gmail.com>, T J Thomas <tjthomas.6125@gmail.com>, Subhash T J <tjsubhash@gmail.com>, Beby Mathew <bebymathew@gmail.com>, MADHU S NAIR <cmd@cochinshipyard.com>, Edgar Morris <edgarfmorris@gmail.com>, Hudson Peter <hudsonpeter4@gmail.com>, PRINCIPAL SSET <principalsset@scmsgroup.org>

Bcc:

Date: Fri, 26 May 2023 13:20:34 +0530

Subject: Re: Invitation of Applications from SCMS for MATSUE INTERNSHIP PROGRAM - JAN 28 - FEB 10 , 2024 in Matsue city, JAPAN - Deadline: MAY 31, 2023

----- Message truncated -----

Dr. Varun G Menon <varunmenon@scmsgroup.org>

Mon, Jun 5, 2023 at 5:43 PM

To: HOD Computer Science Engineering Department <hodcssset@scmsgroup.org>

----- Forwarded message -----

From: **Dr. Varun G Menon** <varunmenon@scmsgroup.org>

Date: Fri, May 26, 2023 at 1:20 PM

Subject: Re: Invitation of Applications from SCMS for MATSUE INTERNSHIP PROGRAM - JAN 28 - FEB 10 , 2024 in Matsue city, JAPAN - Deadline: MAY 31, 2023

To: Asa Kerala <asanipponkerala@gmail.com>

[Quoted text hidden]

[Quoted text hidden]

[Quoted text hidden]

Thanks and Regards,

[Quoted text hidden]

[Quoted text hidden]

Dr. Varun G Menon <varunmenon@scmsgroup.org>

Sat, Jul 29, 2023 at 10:48 AM

To: Asa Kerala <asanipponkerala@gmail.com>

Cc: Gopakumar S <meenagopan1984@gmail.com>, T J Thomas <tjthomas.6125@gmail.com>, Subhash T J <tjsubhash@gmail.com>, Beby Mathew <bebymathew@gmail.com>, MADHU S NAIR <cmd@cochinshipyard.com>, Edgar Morris <edgarfmorris@gmail.com>, Hudson Peter <hudsonpeter4@gmail.com>, MEENAKSHY R NAMBIAR <meenakshynambiar12@gmail.com>, Alan Varghese Paul <alanvarghesepaul29@gmail.com>

Dear Sir,

I hope everything is going well. We just received the academic calendar for the semester from APJ Abdul Kalam Kerala Technological University. The commencement date of the end semester university examination for B.Tech S7 (Ms. Meenakshy and Mr. Alan) is given as 20th January. Kindly do the needful, and also, if we need to inform the same to Matsue authorities. Attaching the calendar for your perusal.

Thank you

On Fri, Apr 28, 2023 at 10:55 PM Asa Kerala <asanipponkerala@gmail.com> wrote:

[Quoted text hidden]

[Quoted text hidden]



BTech Academic Calendar.pdf

257K

Dr. Varun G Menon <varunmenon@scmsgroup.org>

Sat, Jul 29, 2023 at 11:07 AM

To: PRINCIPAL SSET <principalsset@scmsgroup.org>

Ma'am,

For your information. I forgot to keep a cc to you.

Thank you

----- Forwarded message -----

From: **Dr. Varun G Menon** <varunmenon@scmsgroup.org>

Date: Sat, Jul 29, 2023 at 10:48 AM

Subject: Re: Invitation of Applications from SCMS for MATSUE INTERNSHIP PROGRAM - JAN 28 - FEB 10 , 2024 in Matsue city, JAPAN - Deadline: MAY 31, 2023

To: Asa Kerala <asanipponkerala@gmail.com>

[Quoted text hidden]

[Quoted text hidden]

[Quoted text hidden]



BTech Academic Calendar.pdf

257K

Mail Delivery Subsystem <mailer-daemon@googlemail.com>

Sun, Jul 30, 2023 at 2:03 PM

To: varunmenon@scmsgroup.org



Delivery incomplete

There was a temporary problem delivering your message to **cmd@cochinshipyard.com**. Gmail will retry for 44 more hours. You'll be notified if the delivery fails permanently.

[LEARN MORE](#)

The response was:

The recipient server did not accept our requests to connect. Learn more at <https://support.google.com/mail/answer/7720> [cochinshipyard.com 162.215.226.3: timed out]

Final-Recipient: rfc822; cmd@cochinshipyard.com

Action: delayed

Status: 4.4.1

Diagnostic-Code: smtp; The recipient server did not accept our requests to connect. Learn more at <https://support.google.com/mail/answer/7720>

[cochinshipyard.com 162.215.226.3: timed out]

Last-Attempt-Date: Sun, 30 Jul 2023 01:33:07 -0700 (PDT)

Will-Retry-Until: Mon, 31 Jul 2023 22:18:45 -0700 (PDT)

----- Forwarded message -----

From: "Dr. Varun G Menon" <varunmenon@scmsgroup.org>

To: Asa Kerala <asanipponkerala@gmail.com>

Cc: Gopakumar S <meenagopan1984@gmail.com>, T J Thomas <tjthomas.6125@gmail.com>, Subhash T J <tjsubhash@gmail.com>, Beby Mathew <bebymathew@gmail.com>, MADHU S NAIR <cmd@cochinshipyard.com>, Edgar Morris <edgarfmorris@gmail.com>, Hudson Peter <hudsonpeter4@gmail.com>, MEENAKSHY R NAMBIAR <meenakshynambiar12@gmail.com>, Alan Varghese Paul <alanvarghesepaul29@gmail.com>

Bcc:

Date: Sat, 29 Jul 2023 10:48:32 +0530

Subject: Re: Invitation of Applications from SCMS for MATSUE INTERNSHIP PROGRAM - JAN 28 - FEB 10 , 2024 in Matsue city, JAPAN - Deadline: MAY 31, 2023

----- Message truncated -----

Mail Delivery Subsystem <mailer-daemon@googlemail.com>

To: varunmenon@scmsgroup.org

Mon, Jul 31, 2023 at 3:17 PM



Delivery incomplete

There was a temporary problem delivering your message to **cmd@cochinshipyard.com**. Gmail will retry for 19 more hours. You'll be notified if the delivery fails permanently.

[LEARN MORE](#)

The response was:

The recipient server did not accept our requests to connect. Learn more at <https://support.google.com/mail/answer/7720> [cochinshipyard.com 162.215.226.3: timed out]

Final-Recipient: rfc822; cmd@cochinshipyard.com

Action: delayed

Status: 4.4.1

Diagnostic-Code: smtp; The recipient server did not accept our requests to connect. Learn more at <https://support.google.com/mail/answer/7720> [cochinshipyard.com 162.215.226.3: timed out]

Last-Attempt-Date: Mon, 31 Jul 2023 02:47:47 -0700 (PDT)

Will-Retry-Until: Mon, 31 Jul 2023 22:18:45 -0700 (PDT)

----- Forwarded message -----

From: "Dr. Varun G Menon" <varunmenon@scmsgroup.org>

To: Asa Kerala <asanipponkerala@gmail.com>

Cc: Gopakumar S <meenagopan1984@gmail.com>, T J Thomas <tjthomas.6125@gmail.com>, Subhash T J <tjsubhash@gmail.com>, Beby Mathew <bebymathew@gmail.com>, MADHU S NAIR <cmd@cochinshipyard.com>, Edgar Morris <edgarfmorris@gmail.com>, Hudson Peter <HUDSONPETER4@gmail.com>, MEENAKSHY R NAMBIAR <meenakshynambiar12@gmail.com>, Alan Varghese Paul <alanvarghesepaul29@gmail.com>

Bcc:

Date: Sat, 29 Jul 2023 10:48:32 +0530

Subject: Re: Invitation of Applications from SCMS for MATSUE INTERNSHIP PROGRAM - JAN 28 - FEB 10 , 2024 in Matsue city, JAPAN - Deadline: MAY 31, 2023

----- Message truncated -----

Mail Delivery Subsystem <mailer-daemon@googlemail.com>

Tue, Aug 1, 2023 at 11:32 AM

To: varunmenon@scmsgroup.org



Message not delivered

There was a problem delivering your message to cmd@cochinshipyard.com. See the technical details below.

[LEARN MORE](#)

The response was:

The recipient server did not accept our requests to connect. Learn more at <https://support.google.com/mail/answer/7720> [cochinshipyard.com 162.215.226.3: timed out]

Final-Recipient: rfc822; cmd@cochinshipyard.com

Action: failed

Status: 4.4.1

Diagnostic-Code: smtp; The recipient server did not accept our requests to connect. Learn more at <https://support.google.com/mail/answer/7720>

[cochinshipyard.com 162.215.226.3: timed out]

Last-Attempt-Date: Mon, 31 Jul 2023 23:02:05 -0700 (PDT)

----- Forwarded message -----

From: "Dr. Varun G Menon" <varunmenon@scmsgroup.org>

To: Asa Kerala <asanipponkerala@gmail.com>

Cc: Gopakumar S <meenagopan1984@gmail.com>, T J Thomas <tjthomas.6125@gmail.com>, Subhash T J <tjsubhash@gmail.com>, Beby Mathew <bebymathew@gmail.com>, MADHU S NAIR <cmd@cochinshipyard.com>, Edgar Morris <edgarfmorris@gmail.com>, Hudson Peter <hudsonpeter4@gmail.com>, MEENAKSHY R NAMBIAR <meenakshynambiar12@gmail.com>, Alan Varghese Paul <alanvarghesepaul29@gmail.com>

Bcc:

Date: Sat, 29 Jul 2023 10:48:32 +0530

Subject: Re: Invitation of Applications from SCMS for MATSUE INTERNSHIP PROGRAM - JAN 28 - FEB 10 , 2024 in Matsue city, JAPAN - Deadline: MAY 31, 2023

----- Message truncated -----

Dr. Varun G Menon <varunmenon@scmsgroup.org>

Sat, Aug 19, 2023 at 12:25 PM

To: Asa Kerala <asanipponkerala@gmail.com>

Cc: Gopakumar S <meenagopan1984@gmail.com>, T J Thomas <tjthomas.6125@gmail.com>, Subhash T J <tjsubhash@gmail.com>, Beby Mathew <bebymathew@gmail.com>, Edgar Morris <edgarfmorris@gmail.com>, Hudson Peter <hudsonpeter4@gmail.com>, MEENAKSHY R NAMBIAR <meenakshynambiar12@gmail.com>, Alan Varghese Paul <alanvarghesepaul29@gmail.com>, PRINCIPAL SSET <principalsset@scmsgroup.org>, Sindhya K <sindhya@scmsgroup.org>, Arshey M <arsheym@scmsgroup.org>

Dear Sir,

I hope you are doing well. Please find the attached final academic calendar published by APJ Abdul Kalam Kerala Technological University. The commencement date of the end-semester university examination for B.Tech S7 (Ms. Meenakshy and Mr. Alan) has been changed to 5th January 2023. So we believe that all the examinations will be over before the commencement date of the Matsue internship. Just keeping you posted.

Regards,

Varun

[Quoted text hidden]



B. Tech Academic Calendar_S3_S5_S7 (Odd Semester 2023-24) (1).pdf

292K



**MEMORANDUM OF UNDERSTANDING (MoU)
AND ACADEMIC COLLABORATION**

BETWEEN

SCMS GROUP OF EDUCATIONAL INSTITUTIONS, COCHIN, INDIA

AND

DAFFODIL INTERNATIONAL UNIVERSITY, DHAKA, BANGLADESH

SCMS Group of Educational Institutions, Cochin, India and Daffodil International University, Dhaka, Bangladesh, aim to establish and develop a close partnership to promote academic and cultural exchanges between the two Institutions through mutual assistance, specially, in the areas of teaching and research.

This Agreement of Co-operation, upon approval of the Vice Chancellor of Daffodil International University and the Vice Chairman of SCMS Group of Educational Institutions will serve as a general framework for institutional co-operation. It will facilitate faculty members to discuss and develop specific programs of co-operation. Each University will designate a liaison officer to co-ordinate the application of this Agreement in the best interest of both Institutions. Co-operative relations shall be carried out through the activities such as:

- **Short Project Internships / Study Tours / Summer Program:** Students from partner universities will agree to participate in Short Project Internships / Study Tours / Summer Program in various research areas. The partner institution will circulate the notices and program plan among students and motivate them to attend the program for capacity building and cross cultural education.
- **Faculty Exchange:** The exchange of academic staff for short duration in order to share expertise and knowledge among staff and students of both institutions.
- **Resources Share:** The acquiescence of access to the Library database, Journal and other online resources for both staff and students of each university.
- **Blended Learning Courses:** Both Partner institutions may arrange blender learning courses/program for the students where students will study specific subjects in their home institution and rest of them will complete in the partner institution
- **Scholarship Opportunity:** Both Institution may arrange scholarship opportunity for meritorious students of partner institution and cooperate accordingly.

The provisions and activities specified in this Agreement are subjected to the availability of funds and the approval of the Authorized Officers of both Institutions. A separate financial agreement to be finalized prior to implementation of the program arrangement.

The Agreement shall take effect from the date of signing and shall be valid for an initial period of 5 (five) years. Any amendment and/or modification of this Agreement require the written approval of the Vice Chancellor of Daffodil International University and the Vice Chairman of SCMS Group of Educational Institutions and shall be appended hereto. Neither University shall take action relative to this Agreement without consultation with the partner in this Agreement.

**Signed on behalf of
SCMS Group of Educational Institutions
India**

**Signed on behalf of
Daffodil International University
Bangladesh**



Prof. Pramod P Thevanoor
Vice Chairman
SCMS Group of Educational Institutions

Date: 25/07/2018



Prof. Dr. Yousuf Mahbubul Islam
Vice Chancellor
Daffodil International University

Date: 25/07/2018



SCMS

GROUP OF EDUCATIONAL INSTITUTIONS

SCMS CAMPUS, PRATHAP NAGAR, MUTTOM, ALUVA, COCHIN - 683 106, INDIA
Phone: 91-484-2628000, 3231976 • Email: scms@scmsgroup.org • Website: www.scmsgroup.org

SSET/155/19/0638

14.05.2019

Mr. Ramit Arko
Student – ID 181-33-4450
Electrical and Electronics Engineering
Daffodil International University
Dattapara, Ashulia
Savar, Dhaka.

Dear Mr. Ramit Arko,

We have pleasure to invite you to our campus to participate in the Internship / Study Tour program for International students offered by Centre for Robotics, SCMS School of Engineering and Technology.

The objective of this programme is to impart knowledge in the field of robotics to students from all streams of engineering and help them build prototypes and make their innovative ideas come to reality. The program duration is two weeks - June 16 – July 1, 2019.

We look forward to your visit to our campus and we wish you all the best.

Yours sincerely,

PRAMOD P. THEVANNOOR
VICE CHAIRMAN – SCMS GROUP



MEMBER INSTITUTIONS

- ▶ SCMS COCHIN SCHOOL OF BUSINESS
- ▶ SCMS School of Technology and Management
- ▶ SCMS School of Engineering and Technology
- ▶ SCMS School of Architecture
- ▶ SCMS College of Polytechnics
- ▶ SCMS Institute for Bioscience and Biotechnology
- ▶ SCMS Water Institute
- ▶ SCMS Centre for Research, Consultancy and Training



SCMS

GROUP OF EDUCATIONAL INSTITUTIONS

SCMS CAMPUS, PRATHAP NAGAR, MUTTOM, ALUVA, COCHIN - 683 106, INDIA
Phone: 91-484-2628000, 3231976 • Email: scms@scmsgroup.org • Website: www.scmsgroup.org

SSET/155/19/0638

14.05.2019

Mr.Md. Sazzad Sarker (Passport No. EA0142391)

Student – ID 181-33-4594

Electrical and Electronics Engineering

Daffodil International University

Dattapara, Ashulia

Savar, Dhaka.

Dear Mr. Md. Sazzad Sarker,

We have pleasure to invite you to our campus to participate in the Internship / Study Tour program for International students offered by Centre for Robotics, SCMS School of Engineering and Technology.

The objective of this programme is to impart knowledge in the field of robotics to students from all streams of engineering and help them build prototypes and make their innovative ideas come to reality. The program duration is two weeks - June 16 – July 1, 2019.

We look forward to your visit to our campus and we wish you all the best.

Yours sincerely,

PRAMOD P. THEVANNOOR
VICE CHAIRMAN – SCMS GROUP



MEMBER INSTITUTIONS

- ▶ SCMS COCHIN SCHOOL OF BUSINESS
- ▶ SCMS School of Technology and Management
- ▶ SCMS School of Engineering and Technology
- ▶ SCMS School of Architecture
- ▶ SCMS College of Polytechnics
- ▶ SCMS Institute for Bioscience and Biotechnology
- ▶ SCMS Water Institute
- ▶ SCMS Centre for Research, Consultancy and Training



SCMS

GROUP OF EDUCATIONAL INSTITUTIONS

SCMS CAMPUS, PRATHAP NAGAR, MUTTOM, ALUVA, COCHIN - 683 106, INDIA
Phone: 91-484-2628000, 3231976 • Email: scms@scmsgroup.org • Website: www.scmsgroup.org

SSET/155/19/0638

14.05.2019

Mr.M.Atiq Faisal Rafi (Passport No. BY0667816)

Student – ID 172-15-10028

Computer Science and Engineering

Daffodil International University

Dattapara, Ashulia

Savar, Dhaka.

Dear Mr. Atiq Faisal Rafi,

We have pleasure to invite you to our campus to participate in the Internship / Study Tour program for International students offered by Centre for Robotics, **SCMS School of Engineering and Technology**.

The objective of this programme is to impart knowledge in the field of robotics to students from all streams of engineering and help them build prototypes and make their innovative ideas come to reality. The program duration is two weeks - **June 16 – July 1, 2019**.

We look forward to your visit to our campus and we wish you all the best.

Yours sincerely,

PRAMOD P.THEVANNOOR
VICE CHAIRMAN – SCMS GROUP



MEMBER INSTITUTIONS

- ▶ SCMS COCHIN SCHOOL OF BUSINESS
- ▶ SCMS School of Technology and Management
- ▶ SCMS School of Engineering and Technology
- ▶ SCMS School of Architecture
- ▶ SCMS College of Polytechnics
- ▶ SCMS Institute for Bioscience and Biotechnology
- ▶ SCMS Water Institute
- ▶ SCMS Centre for Research, Consultancy and Training



SCMS

GROUP OF EDUCATIONAL INSTITUTIONS

SCMS CAMPUS, PRATHAP NAGAR, MUTTOM, ALUVA, COCHIN - 683 106, INDIA
Phone: 91-484-2628000, 3231976 • Email: scms@scmsgroup.org • Website: www.scmsgroup.org

SSET/155/19/0638

14.05.2019

Mr. Nimai Chandra Das (Passport No. EA0270621)
Student – ID 143-33-2265
Electrical and Electronics Engineering
Daffodil International University
Dattapara, Ashulia
Savar, Dhaka.

Dear Mr. Nimai Chandra Das,

We have pleasure to invite you to our campus to participate in the Internship / Study Tour program for International students offered by Centre for Robotics, SCMS School of Engineering and Technology.

The objective of this programme is to impart knowledge in the field of robotics to students from all streams of engineering and help them build prototypes and make their innovative ideas come to reality. The program duration is two weeks - June 16 – July 1, 2019.

We look forward to your visit to our campus and we wish you all the best.

Yours sincerely,

PRAMOD P. THEVANNOOR
VICE CHAIRMAN – SCMS GROUP



MEMBER INSTITUTIONS

- ▶ SCMS COCHIN SCHOOL OF BUSINESS
- ▶ SCMS School of Technology and Management
- ▶ SCMS School of Engineering and Technology
- ▶ SCMS School of Architecture
- ▶ SCMS College of Polytechnics
- ▶ SCMS Institute for Bioscience and Biotechnology
- ▶ SCMS Water Institute
- ▶ SCMS Centre for Research, Consultancy and Training



SCMS

GROUP OF EDUCATIONAL INSTITUTIONS

SCMS CAMPUS, PRATHAP NAGAR, MUTTOM, ALUVA, COCHIN - 683 106, INDIA
Phone: 91-484-2628000, 3231976 • Email: scms@scmsgroup.org • Website: www.scmsgroup.org

SSET/155/19/0639

14.05.2019

Mr. Khandker M. Qaiduzzaman
Lecturer
Department of Software Engineering
Daffodil International University
Dattapara, Ashulia
Savar, Dhaka.

Dear Mr. Khandker Qaiduzzaman,

We have pleasure to invite you to our campus to engage in sessions for our students and faculty as part of the Exchange Programme between our institutions.

The objective of the association between **SCMS Group of Educational Institutions and Daffodil International University, Dhaka, Bangladesh**, is to establish and develop a close partnership to promote academic and cultural exchanges between the two Institutions through mutual assistance, specially, in the areas of teaching and research.

We look forward to your visit to our campus.

Yours sincerely,

PRAMOD P. THEVANNOOR
VICE CHAIRMAN – SCMS GROUP



MEMBER INSTITUTIONS

- ▶ SCMS COCHIN SCHOOL OF BUSINESS
- ▶ SCMS School of Technology and Management
- ▶ SCMS School of Engineering and Technology
- ▶ SCMS School of Architecture
- ▶ SCMS College of Polytechnics
- ▶ SCMS Institute for Bioscience and Biotechnology
- ▶ SCMS Water Institute
- ▶ SCMS Centre for Research, Consultancy and Training



Varun Menon G <varunmenon@scmsgroup.org>

Academic Collaboration with Daffodil International University

50 messages

Dr. Varun G Menon <varunmenon@scmsgroup.org>
To: morsalin.a@daffodilvarsity.edu.bd

Tue, Jun 19, 2018 at 11:09 AM

Respected Mr. Salahuddin Morsalin

Thank you for your time and consideration. Let me introduce as Dr. Varun G Menon, in charge of International Collaborations at SCMS Group of Educational Institutions, India.

We are interested in having academic collaboration with Daffodil International University. Collaboration could be in the areas of student exchange programs, faculty exchange programs, research collaborations, joint seminars and conferences.

We have a dedicate team of faculty and students working in areas like Robotics, Brain Signal Analysis, Computational fluid dynamics. Water Quality Monitoring and Assessment, Limnology, Water Audit, Environmental Remote Sensing , Android Malware Analysis. Research collaborations in these areas is another possibility.

We have academic collaborations with leading international universities like Vrije University-Brussels, Furtwangen University-Germany, University of Applied Sciences Ravensburg Weingarten- Germany, Shimane University-Japan and more.

Please let me know if we could discuss and take forward this initiative.

For your information we are the No 1 ranked private educational institutions in the state. You can find more information about our institutions in www.scmsgroup.org and about out Engineering Institute in www.scmsgroup.org/sset/

Have a Great Day.

Thanks and Regards,

Dr. Varun G Menon

Associate Professor-Computer Science Engineering

Exe. Officer-Corporate Relations & International Collaborations

SCMS School of Engineering and Technology

Kerala, India-683582

Office: +91-484-2450330 Mob: +91-8714504684

Web: <http://www.scmsgroup.org/sset/computer-science-engineering/dr-varun-g-menon>



SCMS

School of Engineering & Technology

International Affairs, DIU <int@daffodilvarsity.edu.bd>

Sat, Jun 23, 2018 at 6:42 PM

To: varunmenon@scmsgroup.org

Cc: "Office of the International Affairs, DIU" <mobility@daffodilvarsity.edu.bd>, Scholarship News <scholarship@daffodilvarsity.edu.bd>, "International, DIU" <international@daffodilvarsity.edu.bd>

Dear Dr. Varun G Menon,

Greetings from DIU!

Thanks for your email and showing interest in the academic partnership. Yes, we can Ccollaborate in the areas of student exchange programs, faculty exchange programs, summer school research collaborations, joint seminars and conferences.

I have attached here the sample agreement copy of DIU, Could you please check and fill it with your information. Besides, I have attached here the fact sheet of DIU where you can check our common details and department.

Your CSE, ECE and EEE Department can be a good prospect between both universities. Let us know your observation

Looking forward to hearing from you soon.

- With best regards

Syed Raihan-UI-Islam

Senior Administrative Officer, International Affairs

Daffodil International University

102/1, Shukrabad, Dhanmondi, Dhaka-1207, Bangladesh.

Tel: +88 02 9138234 (Ext: 237) | Mob: +88-01811458865

WhatsApp/Viber/Wechat: +88-01920012744

[Quoted text hidden]

2 attachments

 **MOU Draft_Between DIU and Other University (1).doc**
213K

 **Fact Sheet about Daffodil International University.doc**
263K

Dr. Varun G Menon <varunmenon@scmsgroup.org>

Sun, Jun 24, 2018 at 12:05 AM

To: "International Affairs, DIU" <int@daffodilvarsity.edu.bd>

Cc: "Office of the International Affairs, DIU" <mobility@daffodilvarsity.edu.bd>, Scholarship News <scholarship@daffodilvarsity.edu.bd>, "International, DIU" <international@daffodilvarsity.edu.bd>

Dear Mr. Syed Raihan-UI-Islam,

Thank you for the information about Daffodil International University. Will complete the agreement copy and send you at the earliest.

We have 5 active research groups in our Engineering College that include Centre for Robotics, Centre for Cyber Security, Hydrodynamics and Computational Fluid Dynamics, Antennas and Radiation, Centre for Sustainable Water Technology and Management. Students from your University can do summer internships and short term projects with these project groups.

Besides we also have one of the leading Management Institute in India and also Biotechnology Research Centre.

Thank you for the collaboration. Will send you the document soon.

Regards,

Dr. Varun G Menon

Associate Professor-Computer Science Engineering

Exe. Officer-Corporate Relations & International Collaborations

SCMS School of Engineering and Technology

Kerala, India-683582

Office: +91-484-2450330 Mob: +91-8714504684

Web: <http://www.scmsgroup.org/sset/computer-science-engineering/dr-varun-g-memon>



SCMS
School of Engineering & Technology

[Quoted text hidden]

International Affairs, DIU <int@daffodilvarsity.edu.bd>

Sun, Jun 24, 2018 at 12:17 AM

To: "Dr. Varun G Menon" <varunmenon@scmsgroup.org>

Cc: "Office of the International Affairs, DIU" <mobility@daffodilvarsity.edu.bd>, Scholarship News

<scholarship@daffodilvarsity.edu.bd>, "International, DIU" <international@daffodilvarsity.edu.bd>, Emran Hossain <emran@daffodilvarsity.edu.bd>

Dear Dr, Varun

Thank you very much for your quick response.

It would be great if you can share any proposal or program plan with all details, course plan, costing etc of the Summer internships based on Cyber Security and Robotics so that we could check and show t our students for interest.

Hope to receive the agreement and the program proposals soon. Have a great day !

- With best regards

Syed Raihan-UI-Islam

Senior Administrative Officer, International Affairs

Daffodil International University

102/1, Shukrabad, Dhanmondi, Dhaka-1207, Bangladesh.

Tel: **+88 02 9138234 (Ext: 237)** | Mob: **+88-01811458865**

WhatsApp/Viber/Wechat: **+88-01920012744**

[Quoted text hidden]

Dr. Varun G Menon <varunmenon@scmsgroup.org>

Sun, Jun 24, 2018 at 12:56 AM

To: "International Affairs, DIU" <int@daffodilvarsity.edu.bd>

Cc: "Office of the International Affairs, DIU" <mobility@daffodilvarsity.edu.bd>, Scholarship News

<scholarship@daffodilvarsity.edu.bd>, "International, DIU" <international@daffodilvarsity.edu.bd>, Emran Hossain

<emran@daffodilvarsity.edu.bd>

Dear Mr. Syed Raihan-UI-Islam,

Thank you for the email. Will inform the Professor's in charge of the Cyber Security and Robotics research centers about the program plan.

Will sent you the documents soon.

Have a Great Day.

Thanks and Regards,

Dr. Varun G Menon

Associate Professor-Computer Science Engineering

Exe. Officer-Corporate Relations & International Collaborations

SCMS School of Engineering and Technology

Kerala, India-683582

Office: +91-484-2450330 Mob: +91-8714504684

Web: <http://www.scmsgroup.org/sset/computer-science-engineering/dr-varun-g-menon>



SCMS
School of Engineering & Technology

[Quoted text hidden]

Dr. Varun G Menon <varunmenon@scmsgroup.org>

Mon, Jun 25, 2018 at 3:44 PM

To: "International Affairs, DIU" <int@daffodilvarsity.edu.bd>

Cc: "Office of the International Affairs, DIU" <mobility@daffodilvarsity.edu.bd>, Scholarship News

<scholarship@daffodilvarsity.edu.bd>, "International, DIU" <international@daffodilvarsity.edu.bd>, Emran Hossain

<emran@daffodilvarsity.edu.bd>

Dear Mr. Syed Raihan-UI-Islam,

Thank you for the collaboration with SCMS. I have presented the MoU with the Vice Chairman for approval. Once the approval is obtained, I will send back the approved soft copy of the MoU.

I have discussed about the Short Term Internships for students from DIU at the Centre for Robotics, SCMS with the Director, Robotics Lab. He has promised to send me The Best Plan for DIU students within two days. I will send you the same at the earliest.

Thanks and Regards,

Dr. Varun G Menon

Associate Professor-Computer Science Engineering

Exe. Officer-Corporate Relations & International Collaborations

SCMS School of Engineering and Technology

Kerala, India-683582

Office: +91-484-2450330 Mob: +91-8714504684

Web: <http://www.scmsgroup.org/sset/computer-science-engineering/dr-varun-g-menon>



SCMS
School of Engineering & Technology

[Quoted text hidden]

International Affairs, DIU <int@daffodilvarsity.edu.bd>

Mon, Jun 25, 2018 at 3:55 PM

To: "Dr. Varun G Menon" <varunmenon@scmsgroup.org>

Cc: "Office of the International Affairs, DIU" <mobility@daffodilvarsity.edu.bd>, Scholarship News

<scholarship@daffodilvarsity.edu.bd>, "International, DIU" <international@daffodilvarsity.edu.bd>, Emran Hossain <emran@daffodilvarsity.edu.bd>

Dear Dr. Varun

Thank you so much for your email and letting us know the update.

- With best regards

Syed Raihan-UI-Islam

Senior Administrative Officer, International Affairs

Daffodil International University

102/1, Shukrabad, Dhanmondi, Dhaka-1207, Bangladesh.

Tel: +88 02 9138234 (Ext: 237) | Mob: +88-01811458865

WhatsApp/Viber/Wechat: +88-01920012744

[Quoted text hidden]

Dr. Varun G Menon <varunmenon@scmsgroup.org>

Tue, Jun 26, 2018 at 6:31 PM

To: "International Affairs, DIU" <int@daffodilvarsity.edu.bd>

Cc: "Office of the International Affairs, DIU" <mobility@daffodilvarsity.edu.bd>, Scholarship News

<scholarship@daffodilvarsity.edu.bd>, "International, DIU" <international@daffodilvarsity.edu.bd>, Emran Hossain

<emran@daffodilvarsity.edu.bd>, Pramod <pramod@scmsgroup.org>, Indu Nair <indunair@scmsgroup.org>, "Dr. Praveensal C.J." <praveensal@scmsgroup.org>

Dear Mr. Syed Raihan-UI-Islam,

Thank you for the collaboration with SCMS. Please see the attached MoU draft approved by our Vice Chairman. Please let me know the remaining procedures including the signing of the MoU.

Thanks and Regards,

Dr. Varun G Menon

Associate Professor-Computer Science Engineering

Exe. Officer-Corporate Relations & International Collaborations

SCMS School of Engineering and Technology

Kerala, India-683582

Office: +91-484-2450330 Mob: +91-8714504684

Web: <http://www.scmsgroup.org/sset/computer-science-engineering/dr-varun-g-menon>



SCMS
School of Engineering & Technology

[Quoted text hidden]

 **MOU_SCMS and Daffodil University_26-6-18.doc**

90K

Dr. Varun G Menon <varunmenon@scmsgroup.org>
To: Varun Menon G <varunmenon@scmsgroup.org>

Tue, Jun 26, 2018 at 6:32 PM

[Quoted text hidden]

 **MOU_SCMS and Daffodil University_26-6-18.doc**
90K

International Affairs, DIU <int@daffodilvarsity.edu.bd>
To: "Dr. Varun G Menon" <varunmenon@scmsgroup.org>

Tue, Jun 26, 2018 at 6:54 PM

Cc: "Office of the International Affairs, DIU" <mobility@daffodilvarsity.edu.bd>, Scholarship News <scholarship@daffodilvarsity.edu.bd>, "International, DIU" <international@daffodilvarsity.edu.bd>, Emran Hossain <emran@daffodilvarsity.edu.bd>, Pramod <pramod@scmsgroup.org>, Indu Nair <indunair@scmsgroup.org>, "Dr. Praveensal C.J." <praveensal@scmsgroup.org>

Dear Dr. Varun

Thank you very much for the agreement final copy. It's fine

May I request you to sign the agreement and send the copies to me either scan copy in my email or 2 original copies in my address given in my email signature

- *With best regards*

Syed Raihan-UI-Islam

Senior Administrative Officer, International Affairs

Daffodil International University

102/1, Shukrabad, Dhanmondi, Dhaka-1207, Bangladesh.

Tel: **+88 02 9138234 (Ext: 237)** | Mob: **+88-01811458865**

WhatsApp/Viber/Wechat: **+88-01920012744**

[Quoted text hidden]

Dr. Varun G Menon <varunmenon@scmsgroup.org>
To: "International Affairs, DIU" <int@daffodilvarsity.edu.bd>

Tue, Jun 26, 2018 at 10:08 PM

Cc: "Office of the International Affairs, DIU" <mobility@daffodilvarsity.edu.bd>, Scholarship News <scholarship@daffodilvarsity.edu.bd>, "International, DIU" <international@daffodilvarsity.edu.bd>, Emran Hossain <emran@daffodilvarsity.edu.bd>, Pramod <pramod@scmsgroup.org>, Indu Nair <indunair@scmsgroup.org>, "Dr. Praveensal C.J." <praveensal@scmsgroup.org>

Dear Mr. Syed Raihan-UI-Islam,

Thank you for the collaboration with SCMS. We would like to visit the DIU campus on a favorable date and would like to sign the MoU with the Vice Chancellor at DIU.

We would be more than happy to host the DIU team with Vice Chancellor in our campus in future. Please let me know your thoughts.

Thanks and Regards,

Dr. Varun G Menon

Associate Professor-Computer Science Engineering

Exe. Officer-Corporate Relations & International Collaborations

SCMS School of Engineering and Technology

Kerala, India-683582

Office: +91-484-2450330 Mob: +91-8714504684

Web: <http://www.scmsgroup.org/sset/computer-science-engineering/dr-varun-g-menon>



SCMS
School of Engineering & Technology

[Quoted text hidden]

International Affairs, DIU <int@daffodilvarsity.edu.bd> Tue, Jun 26, 2018 at 10:12 PM
To: "Dr. Varun G Menon" <varunmenon@scmsgroup.org>
Cc: "Office of the International Affairs, DIU" <mobility@daffodilvarsity.edu.bd>, Scholarship News <scholarship@daffodilvarsity.edu.bd>, "International, DIU" <international@daffodilvarsity.edu.bd>, Emran Hossain <emran@daffodilvarsity.edu.bd>, Pramod <pramod@scmsgroup.org>, Indu Nair <indunair@scmsgroup.org>, "Dr. Praveensal C.J." <praveensal@scmsgroup.org>

Dear Dr. Varun

That is a good idea. Let us know your possible dates to visit us and sign the agreement between both of the universities.

- With best regards

Syed Raihan-UI-Islam

Senior Administrative Officer, International Affairs
Daffodil International University

102/1, Shukrabad, Dhanmondi, Dhaka-1207, Bangladesh.
Tel: **+88 02 9138234 (Ext: 237)** | Mob: **+88-01811458865**
WhatsApp/Viber/Wechat: **+88-01920012744**

[Quoted text hidden]

Dr. Varun G Menon <varunmenon@scmsgroup.org> Wed, Jun 27, 2018 at 10:25 AM
To: "International Affairs, DIU" <int@daffodilvarsity.edu.bd>
Cc: "Office of the International Affairs, DIU" <mobility@daffodilvarsity.edu.bd>, Scholarship News <scholarship@daffodilvarsity.edu.bd>, "International, DIU" <international@daffodilvarsity.edu.bd>, Emran Hossain <emran@daffodilvarsity.edu.bd>, Pramod <pramod@scmsgroup.org>, Indu Nair <indunair@scmsgroup.org>, "Dr. Praveensal C.J." <praveensal@scmsgroup.org>

Dear Mr. Syed Raihan-UI-Islam,

Thank you for the message. We would like to visit DIU between 10th and 14th July. Please let us know if the date is convenient at your end. Also it would be great if you could send us an Invitation letter which could be produced for the Visa.

Let me know any further details required.

Varun

[Quoted text hidden]

--

[Quoted text hidden]

International Affairs, DIU <int@daffodilvarsity.edu.bd> Wed, Jun 27, 2018 at 10:37 AM
To: "Dr. Varun G Menon" <varunmenon@scmsgroup.org>
Cc: "Office of the International Affairs, DIU" <mobility@daffodilvarsity.edu.bd>, Scholarship News <scholarship@daffodilvarsity.edu.bd>, "International, DIU" <international@daffodilvarsity.edu.bd>, Emran Hossain <emran@daffodilvarsity.edu.bd>, Pramod <pramod@scmsgroup.org>, Indu Nair <indunair@scmsgroup.org>, "Dr. Praveensal C.J." <praveensal@scmsgroup.org>

Dear Dr. Varun

Can we shift it to the next week I mean in between 15 to 20 July?

- With best regards

Syed Raihan-UI-Islam

Senior Administrative Officer, International Affairs
Daffodil International University

102/1, Shukrabad, Dhanmondi, Dhaka-1207, Bangladesh.
Tel: **+88 02 9138234 (Ext: 237)** | Mob: **+88-01811458865**
WhatsApp/Viber/Wechat: **+88-01920012744**

[Quoted text hidden]

Dr. Varun G Menon <varunmenon@scmsgroup.org> Wed, Jun 27, 2018 at 10:48 AM
To: "International Affairs, DIU" <int@daffodilvarsity.edu.bd>

Cc: "Office of the International Affairs, DIU" <mobility@daffodilvarsity.edu.bd>, Scholarship News <scholarship@daffodilvarsity.edu.bd>, "International, DIU" <international@daffodilvarsity.edu.bd>, Emran Hossain <emran@daffodilvarsity.edu.bd>, Pramod <pramod@scmsgroup.org>, Indu Nair <indunair@scmsgroup.org>, "Dr. Praveensal C.J." <praveensal@scmsgroup.org>

Dear Mr. Syed Raihan-UI-Islam,
Can we have the visit between July 24 and 27. Our Vice Chairman is traveling on other dates in July.
Please let me know.
Varun

[Quoted text hidden]
[Quoted text hidden]

International Affairs, DIU <int@daffodilvarsity.edu.bd> Wed, Jun 27, 2018 at 11:29 AM
To: "Dr. Varun G Menon" <varunmenon@scmsgroup.org>
Cc: "Office of the International Affairs, DIU" <mobility@daffodilvarsity.edu.bd>, Scholarship News <scholarship@daffodilvarsity.edu.bd>, "International, DIU" <international@daffodilvarsity.edu.bd>, Emran Hossain <emran@daffodilvarsity.edu.bd>, Pramod <pramod@scmsgroup.org>, Indu Nair <indunair@scmsgroup.org>, "Dr. Praveensal C.J." <praveensal@scmsgroup.org>, "VC Office-2, DIU" <vcoffice2@daffodilvarsity.edu.bd>

Dear Dr. Varun,

I have discussed with the Office of the Vice Chancellor

We can arrange the MoU Signing Ceremony and discussion session on **25 July 2018** from **3PM to 5PM**
We can also arrange to visit our Permanent Campus and Lunch on the on that day 9AM to 2PM too.

Let us know if the time and date is convenient for your visit

Looking forward to hearing from you.

- *With best regards*

Syed Raihan-UI-Islam
Senior Administrative Officer, International Affairs
Daffodil International University
102/1, Shukrabad, Dhanmondi, Dhaka-1207, Bangladesh.
Tel: **+88 02 9138234 (Ext: 237)** | Mob: **+88-01811458865**
WhatsApp/Viber/Wechat: **+88-01920012744**

[Quoted text hidden]

Dr. Varun G Menon <varunmenon@scmsgroup.org> Wed, Jun 27, 2018 at 11:42 AM
To: "International Affairs, DIU" <int@daffodilvarsity.edu.bd>
Cc: "Office of the International Affairs, DIU" <mobility@daffodilvarsity.edu.bd>, Scholarship News <scholarship@daffodilvarsity.edu.bd>, "International, DIU" <international@daffodilvarsity.edu.bd>, Emran Hossain <emran@daffodilvarsity.edu.bd>, Pramod <pramod@scmsgroup.org>, Indu Nair <indunair@scmsgroup.org>, "Dr. Praveensal C.J." <praveensal@scmsgroup.org>, "VC Office-2, DIU" <vcoffice2@daffodilvarsity.edu.bd>

Dear Mr. Syed Raihan-UI-Islam,
Thank you for the information. We will have the visit on 25th July. We will send the details of the members visiting the DIU campus at the earliest.
Regards

[Quoted text hidden]

Dr. Varun G Menon <varunmenon@scmsgroup.org> Wed, Jun 27, 2018 at 11:43 AM
To: "International Affairs, DIU" <int@daffodilvarsity.edu.bd>
Cc: "Office of the International Affairs, DIU" <mobility@daffodilvarsity.edu.bd>, Scholarship News <scholarship@daffodilvarsity.edu.bd>, "International, DIU" <international@daffodilvarsity.edu.bd>, Emran Hossain <emran@daffodilvarsity.edu.bd>, Pramod <pramod@scmsgroup.org>, Indu Nair <indunair@scmsgroup.org>, "Dr. Praveensal C.J." <praveensal@scmsgroup.org>, "VC Office-2, DIU" <vcoffice2@daffodilvarsity.edu.bd>

Dear Mr. Syed Raihan-UI-Islam,
Thank you for the information. We will have the visit on 25th July. We will send the details of the members visiting the DIU campus at the earliest.
Regards

[Quoted text hidden]

Dr. Varun G Menon <varunmenon@scmsgroup.org> Wed, Jun 27, 2018 at 11:43 AM
To: "International Affairs, DIU" <int@daffodilvarsity.edu.bd>
Cc: "Office of the International Affairs, DIU" <mobility@daffodilvarsity.edu.bd>, Scholarship News <scholarship@daffodilvarsity.edu.bd>, "International, DIU" <international@daffodilvarsity.edu.bd>, Emran Hossain <emran@daffodilvarsity.edu.bd>, Pramod <pramod@scmsgroup.org>, Indu Nair <indunair@scmsgroup.org>, "Dr. Praveensal C.J." <praveensal@scmsgroup.org>, "VC Office-2, DIU" <vcoffice2@daffodilvarsity.edu.bd>

Dear Mr. Syed Raihan-UI-Islam,
Thank you for the information. We will have the visit on 25th July. We will send the details of the members visiting the DIU campus at the earliest.
Regards
[Quoted text hidden]

Dr. Varun G Menon <varunmenon@scmsgroup.org> Wed, Jun 27, 2018 at 11:45 AM
To: "International Affairs, DIU" <int@daffodilvarsity.edu.bd>
Cc: "Office of the International Affairs, DIU" <mobility@daffodilvarsity.edu.bd>, Scholarship News <scholarship@daffodilvarsity.edu.bd>, "International, DIU" <international@daffodilvarsity.edu.bd>, Emran Hossain <emran@daffodilvarsity.edu.bd>, Pramod <pramod@scmsgroup.org>, Indu Nair <indunair@scmsgroup.org>, "Dr. Praveensal C.J." <praveensal@scmsgroup.org>, "VC Office-2, DIU" <vcoffice2@daffodilvarsity.edu.bd>

Dear Mr. Syed Raihan-UI-Islam,
Thank you for the information. We will have the visit on 25th July. We will send the details of the members visiting the DIU campus at the earliest.
Regards
[Quoted text hidden]

International Affairs, DIU <int@daffodilvarsity.edu.bd> Wed, Jun 27, 2018 at 11:48 AM
To: "Dr. Varun G Menon" <varunmenon@scmsgroup.org>
Cc: "Office of the International Affairs, DIU" <mobility@daffodilvarsity.edu.bd>, Scholarship News <scholarship@daffodilvarsity.edu.bd>, "International, DIU" <international@daffodilvarsity.edu.bd>, Emran Hossain <emran@daffodilvarsity.edu.bd>, Pramod <pramod@scmsgroup.org>, Indu Nair <indunair@scmsgroup.org>, "Dr. Praveensal C.J." <praveensal@scmsgroup.org>, "VC Office-2, DIU" <vcoffice2@daffodilvarsity.edu.bd>

Dear Dr. Varun

Thanks. I am looking forward.

- With best regards

Syed Raihan-UI-Islam
Senior Administrative Officer, International Affairs
Daffodil International University
102/1, Shukrabad, Dhanmondi, Dhaka-1207, Bangladesh.
Tel: +88 02 9138234 (Ext: 237) | Mob: +88-01811458865
WhatsApp/Viber/Wechat: +88-01920012744

[Quoted text hidden]

Dr. Varun G Menon <varunmenon@scmsgroup.org> Thu, Jun 28, 2018 at 7:50 AM
To: "International Affairs, DIU" <int@daffodilvarsity.edu.bd>
Cc: "Office of the International Affairs, DIU" <mobility@daffodilvarsity.edu.bd>, Scholarship News <scholarship@daffodilvarsity.edu.bd>, "International, DIU" <international@daffodilvarsity.edu.bd>, Emran Hossain <emran@daffodilvarsity.edu.bd>, "VC Office-2, DIU" <vcoffice2@daffodilvarsity.edu.bd>

Dear Mr. Syed Raihan-UI-Islam,

Please see below the details of members visiting DIU on 25th July 2018. Please send us the **invitation letter for the Visa** based on this information.

Names

Prof. **PRAMOD PRATHAPACHANDRAN THEVANNOOR**, Vice Chairman, SCMS Group of Educational Institutions.

Dr. **VARUN GIRIJAN MENON**, Associate Professor and International Relations in-charge, SCMS Group of Educational Institutions.

Address

SCMS Group of Educational Institutions
SCMS Campus, Prathap Nagar
Muttom, Aluva
Cochin – 683 106, Kerala, INDIA

Let me know any further information required.

Thanks and Regards,

Dr. Varun G Menon

Associate Professor-Computer Science Engineering
Exe. Officer-Corporate Relations & International Collaborations
SCMS School of Engineering and Technology
Kerala, India-683582
Office: +91-484-2450330 Mob: +91-8714504684
Web: <http://www.scmsgroup.org/sset/computer-science-engineering/dr-varun-g-memon>



SCMS
School of Engineering & Technology

[Quoted text hidden]

International Affairs, DIU <int@daffodilvarsity.edu.bd> Thu, Jun 28, 2018 at 1:09 PM
To: "Dr. Varun G Menon" <varunmenon@scmsgroup.org>
Cc: "Office of the International Affairs, DIU" <mobility@daffodilvarsity.edu.bd>, Scholarship News <scholarship@daffodilvarsity.edu.bd>, "International, DIU" <international@daffodilvarsity.edu.bd>, Emran Hossain <emran@daffodilvarsity.edu.bd>, "VC Office-2, DIU" <vcoffice2@daffodilvarsity.edu.bd>

Dear Dr. Varun

Please find the attached letter of Invitation for both of you to visit us for the purpose of the meeting and signing the agreement.

- *With best regards*

Syed Raihan-UI-Islam

Senior Administrative Officer, International Affairs
Daffodil International University
102/1, Shukrabad, Dhanmondi, Dhaka-1207, Bangladesh.
Tel: **+88 02 9138234 (Ext: 237)** | Mob: **+88-01811458865**
WhatsApp/Viber/Wechat: **+88-01920012744**

[Quoted text hidden]

2 attachments



Invitation letter for Prof. PRAMOD PRATHAPACHANDRAN THEVANNOOR.jpg
512K

Invitation letter for Dr. VARUN GIRIJAN MENON.jpg
507K



Dr. Varun G Menon <varunmenon@scmsgroup.org> Thu, Jun 28, 2018 at 1:32 PM
 To: "International Affairs, DIU" <int@daffodilvarsity.edu.bd>
 Cc: "Office of the International Affairs, DIU" <mobility@daffodilvarsity.edu.bd>, Scholarship News <scholarship@daffodilvarsity.edu.bd>, "International, DIU" <international@daffodilvarsity.edu.bd>, Emran Hossain <emran@daffodilvarsity.edu.bd>, "VC Office-2, DIU" <vcoffice2@daffodilvarsity.edu.bd>, Pramod <pramod@scmsgroup.org>

Dear Mr. Syed Raihan-UI-Islam,

Thank you for the invitation letter. Looking forward to the meeting. Will update our schedule once we confirm the flight tickets.

Thanks and Regards,

Dr. Varun G Menon

Associate Professor-Computer Science Engineering
 Exe. Officer-Corporate Relations & International Collaborations
 SCMS School of Engineering and Technology
 Kerala, India-683582
 Office: +91-484-2450330 Mob: +91-8714504684
 Web: <http://www.scmsgroup.org/sset/computer-science-engineering/dr-varun-g-menon>



SCMS
 School of Engineering & Technology

[Quoted text hidden]

Dr. Varun G Menon <varunmenon@scmsgroup.org> Sun, Jul 1, 2018 at 12:09 PM
 To: "International Affairs, DIU" <int@daffodilvarsity.edu.bd>
 Cc: "Office of the International Affairs, DIU" <mobility@daffodilvarsity.edu.bd>, Scholarship News <scholarship@daffodilvarsity.edu.bd>, "International, DIU" <international@daffodilvarsity.edu.bd>, Emran Hossain <emran@daffodilvarsity.edu.bd>, "VC Office-2, DIU" <vcoffice2@daffodilvarsity.edu.bd>, Pramod <pramod@scmsgroup.org>, Indu Nair <indunair@scmsgroup.org>, "Dr. Praveensal C.J." <praveensal@scmsgroup.org>

Dear Mr. Syed Raihan-UI-Islam,

Please let me know if you can arrange the MoU signing ceremony and discussion on collaboration at DIU on **25th July morning** as we have flight back to India in the evening.

Thank you,

Dr. Varun G Menon

Associate Professor-Computer Science Engineering
 Exe. Officer-Corporate Relations & International Collaborations
 SCMS School of Engineering and Technology
 Kerala, India-683582
 Office: +91-484-2450330 Mob: +91-8714504684
 Web: <http://www.scmsgroup.org/sset/computer-science-engineering/dr-varun-g-menon>



SCMS
School of Engineering & Technology

[Quoted text hidden]

Dr. Varun G Menon <varunmenon@scmsgroup.org> Tue, Jul 3, 2018 at 4:27 PM
To: "International Affairs, DIU" <int@daffodilvarsity.edu.bd>
Cc: "Office of the International Affairs, DIU" <mobility@daffodilvarsity.edu.bd>, Scholarship News <scholarship@daffodilvarsity.edu.bd>, "International, DIU" <international@daffodilvarsity.edu.bd>, Emran Hossain <emran@daffodilvarsity.edu.bd>, "VC Office-2, DIU" <vcoffice2@daffodilvarsity.edu.bd>, Pramod <pramod@scmsgroup.org>, Indu Nair <indunair@scmsgroup.org>, "Dr. Praveensal C.J." <praveensal@scmsgroup.org>

Dear Mr. Syed Raihan-UI-Islam

Thank you for the valuable time. Please confirm the schedule as discussed and agreed earlier. No need to change the schedule. Our flight is scheduled only in the night.

- MoU Signing Ceremony and discussion session on **25th July 2018** from **3PM to 5PM**
- Visit to DIU Permanent Campus and Lunch on the on that day **9AM to 2PM**

Thanks and Regards,

Dr. Varun G Menon

Associate Professor, Computer Science Engineering
Exe. Officer, Corporate Relations & International Collaborations
SCMS School of Engineering and Technology
Kerala, India-683582
Office: +91-484-2450330 Mob: +91-8714504684
Web: <http://www.scmsgroup.org/sset/computer-science-engineering/dr-varun-g-menon>



SCMS
School of Engineering & Technology

[Quoted text hidden]

International Affairs, DIU <int@daffodilvarsity.edu.bd> Tue, Jul 3, 2018 at 5:04 PM
To: "Dr. Varun G Menon" <varunmenon@scmsgroup.org>
Cc: "Office of the International Affairs, DIU" <mobility@daffodilvarsity.edu.bd>, Scholarship News <scholarship@daffodilvarsity.edu.bd>, "International, DIU" <international@daffodilvarsity.edu.bd>, Emran Hossain <emran@daffodilvarsity.edu.bd>, "VC Office-2, DIU" <vcoffice2@daffodilvarsity.edu.bd>, Pramod <pramod@scmsgroup.org>, Indu Nair <indunair@scmsgroup.org>, "Dr. Praveensal C.J." <praveensal@scmsgroup.org>

Dear Dr. Varun

Yes Confirm so far. Thank You

- *With best regards*

Syed Raihan-UI-Islam

Senior Administrative Officer, International Affairs
Daffodil International University
102/1, Shukrabad, Dhanmondi, Dhaka-1207, Bangladesh.
Tel: **+88 02 9138234 (Ext: 237)** | Mob: **+88-01811458865**
WhatsApp/Viber/Wechat: **+88-01920012744**

[Quoted text hidden]

Dr. Varun G Menon <varunmenon@scmsgroup.org> Thu, Jul 5, 2018 at 2:26 PM
To: "International Affairs, DIU" <int@daffodilvarsity.edu.bd>

Dear Syed,

Please let us know in which campus of DIU is the ceremony and visit arranged. We could see multiple campuses in website. Also let us know good hotel to reserve rooms for stay near the campus.

Regards,

Varun

[Quoted text hidden]

--

Thanks and Regards,

Dr. Varun G Menon

[Quoted text hidden]

Dr. Varun G Menon <varunmenon@scmsgroup.org>

Thu, Jul 5, 2018 at 4:55 PM

To: "International Affairs, DIU" <int@daffodilvarsity.edu.bd>

Cc: "Office of the International Affairs, DIU" <mobility@daffodilvarsity.edu.bd>, Scholarship News

<scholarship@daffodilvarsity.edu.bd>, "International, DIU" <international@daffodilvarsity.edu.bd>, Emran Hossain

<emran@daffodilvarsity.edu.bd>, "VC Office-2, DIU" <vcoffice2@daffodilvarsity.edu.bd>, Pramod <pramod@scmsgroup.org>,

Indu Nair <indunair@scmsgroup.org>, "Dr. Praveensal C.J." <praveensal@scmsgroup.org>, Anupama COK

<anupama@scmsgroup.org>

Dear Mr. Syed Raihan-UI-Islam,

Thank you for the collaboration with SCMS. Please let us know the campus address of DIU where the visit and MoU signing ceremony is planned so that we could arrange the stay in a hotel near the campus. We could see multiple campuses of DIU in the website. It would also be great if you could give the names of few good hotels near your campus.

Thanks and Regards,

Dr. Varun G Menon

Associate Professor, Computer Science Engineering

Exe. Officer, Corporate Relations & International Collaborations

SCMS School of Engineering and Technology

Kerala, India-683582

Office: +91-484-2450330 Mob: +91-8714504684

Web: <http://www.scmsgroup.org/sset/computer-science-engineering/dr-varun-g-menon>



SCMS

School of Engineering & Technology

[Quoted text hidden]

[Quoted text hidden]

[Quoted text hidden]

[Quoted text hidden]

[Quoted text hidden]

[Quoted text hidden]

[Quoted text hidden]

[Quoted text hidden]

[Quoted text hidden]

[Quoted text hidden]

[Quoted text hidden]

[Quoted text hidden]

[Quoted text hidden]

[Quoted text hidden]

[Quoted text hidden]

[Quoted text hidden]

[Quoted text hidden]

[Quoted text hidden]

[Quoted text hidden]

[Quoted text hidden]

[Quoted text hidden]

[Quoted text hidden]

[Quoted text hidden]

[Quoted text hidden]

[Quoted text hidden]

[Quoted text hidden]

[Quoted text hidden]

[Quoted text hidden]

Varun

[Quoted text hidden]

[Quoted text hidden]

[Quoted text hidden]

[Quoted text hidden]

[Quoted text hidden]

[Quoted text hidden]

[Quoted text hidden]

[Quoted text hidden]

[Quoted text hidden]

[Quoted text hidden]

[Quoted text hidden]

[Quoted text hidden]

[Quoted text hidden]

[Quoted text hidden]

[Quoted text hidden]

[Quoted text hidden]

[Quoted text hidden]

[Quoted text hidden]

[Quoted text hidden]

[Quoted text hidden]

[Quoted text hidden]

[Quoted text hidden]

[Quoted text hidden]

[Quoted text hidden]

[Quoted text hidden]

[Quoted text hidden]

[Quoted text hidden]

[Quoted text hidden]

[Quoted text hidden]

[Quoted text hidden]

[Quoted text hidden]

[Quoted text hidden]

[Quoted text hidden]

[Quoted text hidden]

[Quoted text hidden]

Respected Mr. Salahuddin Morsalin

Thank you for your time and consideration. Let me introduce as Dr. Varun G Menon, in charge of International Collaborations at SCMS Group of Educational Institutions, India.

We are interested in having academic collaboration with Daffodil International University. Collaboration could be in the areas of student exchange programs, faculty exchange programs, research collaborations, joint seminars and conferences.

We have a dedicate team of faculty and students working in areas like Robotics, Brain Signal Analysis, Computational fluid dynamics. Water Quality Monitoring and Assessment, Limnology, Water Audit, Environmental Remote Sensing , Android Malware Analysis. Research collaborations in these areas is another possibility.

We have academic collaborations with leading international universities like Vrije University-Brussels, Furtwangen University-Germany, University of Applied Sciences Ravensburg Weingarten- Germany, Shimane University-Japan and more.

Please let me know if we could discuss and take forward this initiative.

For your information we are the No 1 ranked private educational institutions in the state. You can find more information about our

institutions in www.scmsgroup.org and about our Engineering Institute in www.scmsgroup.org/sset/

Have a Great Day.

Thanks and Regards,

Dr. Varun G Menon

Associate Professor-Computer Science Engineering
Exe. Officer-Corporate Relations & International Collaborations
SCMS School of Engineering and Technology
Kerala, India-683582
Office: +91-484-2450330 Mob: +91-8714504684
Web: <http://www.scmsgroup.org/sset/computer-science-engineering/dr-varun-g-menon>



SCMS
School of Engineering & Technology

--
Thanks and Regards,

Dr. Varun G Menon

Associate Professor-Computer Science Engineering
Exe. Officer-Corporate Relations & International Collaborations
SCMS School of Engineering and Technology
Kerala, India-683582
Office: +91-484-2450330 Mob: +91-8714504684
Web: <http://www.scmsgroup.org/sset/computer-science-engineering/dr-varun-g-menon>



SCMS
School of Engineering & Technology

--
Thanks and Regards,

Dr. Varun G Menon

Associate Professor-Computer Science Engineering
Exe. Officer-Corporate Relations & International Collaborations
SCMS School of Engineering and Technology
Kerala, India-683582
Office: +91-484-2450330 Mob: +91-8714504684
Web: <http://www.scmsgroup.org/sset/computer-science-engineering/dr-varun-g-menon>



SCMS
School of Engineering & Technology

--
Thanks and Regards,

Dr. Varun G Menon

[Quoted text hidden]

International Affairs, DIU <int@daffodilvarsity.edu.bd> Mon, Jul 9, 2018 at 10:58 AM
To: "Dr. Varun G Menon" <varunmenon@scmsgroup.org>
Cc: "Office of the International Affairs, DIU" <mobility@daffodilvarsity.edu.bd>, Scholarship News <scholarship@daffodilvarsity.edu.bd>, "International, DIU" <international@daffodilvarsity.edu.bd>, Emran Hossain <emran@daffodilvarsity.edu.bd>, "VC Office-2, DIU" <vcoffice2@daffodilvarsity.edu.bd>, Pramod <pramod@scmsgroup.org>, Indu Nair <indunair@scmsgroup.org>, "Dr. Praveensal C.J." <praveensal@scmsgroup.org>, Anupama COK <anupama@scmsgroup.org>

Dear Dr. Varun,

Here is the address that i already gave you in whatsapp:

[Daffodil International University](#)
102/1, Shukrabad, Dhanmondi, Dhaka-1207
Bangladesh

some hotels nearby our campus:

<http://www.ambalainn.com>

<https://www.panpacific.com/en/hotels-and-resorts/pp-dhaka.html>

- With best regards

Syed Raihan-UI-Islam

Senior Administrative Officer, International Affairs

Daffodil International University

102/1, Shukrabad, Dhanmondi, Dhaka-1207, Bangladesh.

Tel: **+88 02 9138234 (Ext: 237)** | Mob: **+88-01811458865**

WhatsApp/Viber/Wechat: **+88-01920012744**

On Thu, Jul 5, 2018 at 5:25 PM, Dr. Varun G Menon <varunmenon@scmsgroup.org> wrote:

Dear Mr. Syed Raihan-UI-Islam,

Thank you for the collaboration with SCMS. Please let us know the campus address of DIU where the visit and MoU signing ceremony is planned so that we could arrange the stay in a hotel near the campus. We could see multiple campuses of DIU in the website. It would also be great if you could give the names of few good hotels near your campus.

Thanks and Regards,

Dr. Varun G Menon

Associate Professor, Computer Science Engineering

Exe. Officer, Corporate Relations & International Collaborations
SCMS School of Engineering and Technology
Kerala, India-683582
Office: +91-484-2450330 Mob: +91-8714504684
Web: <http://www.scmsgroup.org/sset/computer-science-engineering/dr-varun-g-menon>



SCMS
School of Engineering & Technology

On Tue, Jul 3, 2018 at 5:04 PM, International Affairs, DIU <int@daffodilvarsity.edu.bd> wrote:
Dear Dr. Varun

Yes Confirm so far. Thank You

- With best regards

Syed Raihan-UI-Islam

Senior Administrative Officer, International Affairs
Daffodil International University
102/1, Shukrabad, Dhanmondi, Dhaka-1207, Bangladesh.
Tel: **+88 02 9138234 (Ext: 237)** | Mob: **+88-01811458865**
WhatsApp/Viber/Wechat: **+88-01920012744**

On Tue, Jul 3, 2018 at 3:57 AM, Dr. Varun G Menon <varunmenon@scmsgroup.org> wrote:
Dear Mr. Syed Raihan-UI-Islam

Thank you for the valuable time. Please confirm the schedule as discussed and agreed earlier. No need to change the schedule. Our flight is scheduled only in the night.

- MoU Signing Ceremony and discussion session on **25th July 2018 from 3PM to 5PM**
- Visit to DIU Permanent Campus and Lunch on the on that day **9AM to 2PM**

Thanks and Regards,

Dr. Varun G Menon

Associate Professor, Computer Science Engineering
Exe. Officer, Corporate Relations & International Collaborations
SCMS School of Engineering and Technology
Kerala, India-683582
Office: +91-484-2450330 Mob: +91-8714504684
Web: <http://www.scmsgroup.org/sset/computer-science-engineering/dr-varun-g-menon>



SCMS
School of Engineering & Technology

On Sun, Jul 1, 2018 at 12:09 PM, Dr. Varun G Menon <varunmenon@scmsgroup.org> wrote:
Dear Mr. Syed Raihan-UI-Islam,

Please let me know if you can arrange the MoU signing ceremony and discussion on collaboration at DIU on **25th July morning** as we have flight back to India in the evening.

Thank you,

Dr. Varun G Menon

Associate Professor-Computer Science Engineering
Exe. Officer-Corporate Relations & International Collaborations
SCMS School of Engineering and Technology
Kerala, India-683582
Office: +91-484-2450330 Mob: +91-8714504684
Web: <http://www.scmsgroup.org/sset/computer-science-engineering/dr-varun-g-menon>



SCMS
School of Engineering & Technology

On Thu, Jun 28, 2018 at 1:32 PM, Dr. Varun G Menon <varunmenon@scmsgroup.org> wrote:

Dear Mr. Syed Raihan-UI-Islam,

Thank you for the invitation letter. Looking forward to the meeting. Will update our schedule once we confirm the flight tickets.

Thanks and Regards,

Dr. Varun G Menon

Associate Professor-Computer Science Engineering
Exe. Officer-Corporate Relations & International Collaborations
SCMS School of Engineering and Technology
Kerala, India-683582
Office: +91-484-2450330 Mob: +91-8714504684
Web: <http://www.scmsgroup.org/sset/computer-science-engineering/dr-varun-g-menon>



SCMS
School of Engineering & Technology

On Thu, Jun 28, 2018 at 1:09 PM, International Affairs, DIU <int@daffodilvarsity.edu.bd> wrote:

Dear Dr. Varun

Please find the attached letter of Invitation for both of you to visit us for the purpose of the meeting and signing the agreement.

- With best regards

Syed Raihan-UI-Islam

Senior Administrative Officer, International Affairs
Daffodil International University
102/1, Shukrabad, Dhanmondi, Dhaka-1207, Bangladesh.
Tel: **+88 02 9138234 (Ext: 237)** | Mob: **+88-01811458865**
WhatsApp/Viber/Wechat: **+88-01920012744**

On Thu, Jun 28, 2018 at 8:20 AM, Dr. Varun G Menon <varunmenon@scmsgroup.org> wrote:

Dear Mr. Syed Raihan-UI-Islam,

Please see below the details of members visiting DIU on 25th July 2018. Please send us the **invitation letter for the Visa** based on this information.

Names

Prof. **PRAMOD PRATHAPACHANDRAN THEVANNOOR**, Vice Chairman, SCMS Group of Educational Institutions.

Dr. **VARUN GIRIJAN MENON**, Associate Professor and International Relations in-charge, SCMS Group of Educational Institutions.

Address

SCMS Group of Educational Institutions
SCMS Campus, Prathap Nagar
Muttom, Aluva
Cochin – 683 106, Kerala, INDIA

Let me know any further information required.

Thanks and Regards,

Dr. Varun G Menon

Associate Professor-Computer Science Engineering
Exe. Officer-Corporate Relations & International Collaborations
SCMS School of Engineering and Technology
Kerala, India-683582
Office: +91-484-2450330 Mob: +91-8714504684
Web: <http://www.scmsgroup.org/sset/computer-science-engineering/dr-varun-g-menon>



SCMS
School of Engineering & Technology

On Wed, Jun 27, 2018 at 11:48 AM, International Affairs, DIU <int@daffodilvarsity.edu.bd> wrote:
Dear Dr. Varun

Thanks. I am looking forward.

- With best regards

Syed Raihan-UI-Islam

Senior Administrative Officer, International Affairs
Daffodil International University
102/1, Shukrabad, Dhanmondi, Dhaka-1207, Bangladesh.
Tel: **+88 02 9138234 (Ext: 237)** | Mob: **+88-01811458865**
WhatsApp/Viber/Wechat: **+88-01920012744**

On Wed, Jun 27, 2018 at 12:15 PM, Dr. Varun G Menon <varunmenon@scmsgroup.org> wrote:

Dear Mr. Syed Raihan-UI-Islam,
Thank you for the information. We will have the visit on 25th July. We will send the details of the members visiting the DIU campus at the earliest.
Regards
Varun

On Wednesday, June 27, 2018, International Affairs, DIU <int@daffodilvarsity.edu.bd> wrote:

Dear Dr. Varun,

I have discussed with the Office of the Vice Chancellor

We can arrange the MoU Signing Ceremony and discussion session on **25 July 2018** from **3PM to 5PM**

We can also arrange to visit our Permanent Campus and Lunch on the on that day 9AM to 2PM too.

Let us know if the time and date is convenient for your visit

Looking forward to hearing from you.

- With best regards

Syed Raihan-UI-Islam

Senior Administrative Officer, International Affairs
Daffodil International University
102/1, Shukrabad, Dhanmondi, Dhaka-1207, Bangladesh.
Tel: **+88 02 9138234 (Ext: 237)** | Mob: **+88-01811458865**
WhatsApp/Viber/Wechat: **+88-01920012744**

On Wed, Jun 27, 2018 at 11:18 AM, Dr. Varun G Menon <varunmenon@scmsgroup.org> wrote:

Dear Mr. Syed Raihan-UI-Islam,
Can we have the visit between July 24 and 27. Our Vice Chairman is traveling on other dates in July.
Please let me know.

Varun

On Wednesday, June 27, 2018, International Affairs, DIU <int@daffodilvarsity.edu.bd> wrote:
Dear Dr. Varun

Can we shift it to the next week I mean in between 15 to 20 July?

- With best regards

Syed Raihan-UI-Islam

Senior Administrative Officer, International Affairs

Daffodil International University

102/1, Shukrabad, Dhanmondi, Dhaka-1207, Bangladesh.

Tel: **+88 02 9138234 (Ext: 237)** | Mob: **+88-01811458865**

WhatsApp/Viber/Wechat: **+88-01920012744**

On Wed, Jun 27, 2018 at 10:55 AM, Dr. Varun G Menon <varunmenon@scmsgroup.org> wrote:

Dear Mr. Syed Raihan-UI-Islam,

Thank you for the message. We would like to visit DIU between 10th and 14th July. Please let us know if the date is convenient at your end. Also it would be great if you could send us an Invitation letter which could be produced for the Visa.

Let me know any further details required.

Varun

On Tuesday, June 26, 2018, International Affairs, DIU <int@daffodilvarsity.edu.bd> wrote:

Dear Dr. Varun

That is a good idea. Let us know your possible dates to visit us and sign the agreement between both of the universities.

- With best regards

Syed Raihan-UI-Islam

Senior Administrative Officer, International Affairs

Daffodil International University

102/1, Shukrabad, Dhanmondi, Dhaka-1207, Bangladesh.

Tel: **+88 02 9138234 (Ext: 237)** | Mob: **+88-01811458865**

WhatsApp/Viber/Wechat: **+88-01920012744**

On Tue, Jun 26, 2018 at 10:38 PM, Dr. Varun G Menon <varunmenon@scmsgroup.org> wrote:

Dear Mr. Syed Raihan-UI-Islam,

Thank you for the collaboration with SCMS. We would like to visit the DIU campus on a favorable date and would like to sign the MoU with the Vice Chancellor at DIU.

We would be more than happy to host the DIU team with Vice Chancellor in our campus in future. Please let me know your thoughts.

Thanks and Regards,

Dr. Varun G Menon

Associate Professor-Computer Science Engineering

Exe. Officer-Corporate Relations & International Collaborations

SCMS School of Engineering and Technology

Kerala, India-683582

Office: +91-484-2450330 Mob: +91-8714504684

Web: <http://www.scmsgroup.org/sset/computer-science-engineering/dr-varun-g-menon>



SCMS
School of Engineering & Technology

On Tue, Jun 26, 2018 at 6:54 PM, International Affairs, DIU <int@daffodilvarsity.edu.bd> wrote:

Dear Dr. Varun

Thank you very much for the agreement final copy. It's fine

May I request you to sign the agreement and send the copies to me either scan copy in my email or 2 original copies in my address given in my email signature

- With best regards

Syed Raihan-UI-Islam

Senior Administrative Officer, International Affairs
Daffodil International University

102/1, Shukrabad, Dhanmondi, Dhaka-1207, Bangladesh.

Tel: **+88 02 9138234 (Ext: 237)** | Mob: **+88-01811458865**

WhatsApp/Viber/Wechat: **+88-01920012744**

On Tue, Jun 26, 2018 at 7:01 PM, Dr. Varun G Menon <varunmenon@scmsgroup.org> wrote:

Dear Mr. Syed Raihan-UI-Islam,

Thank you for the collaboration with SCMS. Please see the attached MoU draft approved by our Vice Chairman. Please let me know the remaining procedures including the signing of the MoU.

Thanks and Regards,

Dr. Varun G Menon

Associate Professor-Computer Science Engineering

Exe. Officer-Corporate Relations & International Collaborations

SCMS School of Engineering and Technology

Kerala, India-683582

Office: +91-484-2450330 Mob: +91-8714504684

Web: <http://www.scmsgroup.org/sset/computer-science-engineering/dr-varun-g-menon>



SCMS

School of Engineering & Technology

On Mon, Jun 25, 2018 at 3:55 PM, International Affairs, DIU <int@daffodilvarsity.edu.bd> wrote:

Dear Dr. Varun

Thank you so much for your email and letting us know the update.

- With best regards

Syed Raihan-UI-Islam

Senior Administrative Officer, International Affairs
Daffodil International University

102/1, Shukrabad, Dhanmondi, Dhaka-1207, Bangladesh.

Tel: **+88 02 9138234 (Ext: 237)** | Mob: **+88-01811458865**

WhatsApp/Viber/Wechat: **+88-01920012744**

On Mon, Jun 25, 2018 at 4:14 PM, Dr. Varun G Menon <varunmenon@scmsgroup.org> wrote:

Dear Mr. Syed Raihan-UI-Islam,

Thank you for the collaboration with SCMS. I have presented the MoU with the Vice Chairman for approval. Once the approval is obtained, I will send back the approved soft copy of the MoU.

I have discussed about the Short Term Internships for students from DIU at the Centre for Robotics, SCMS with the Director, Robotics Lab. He has promised to

send me The Best Plan for DIU students within two days. I will send you the same at the earliest.

Thanks and Regards,

Dr. Varun G Menon

Associate Professor-Computer Science Engineering
Exe. Officer-Corporate Relations & International Collaborations
SCMS School of Engineering and Technology
Kerala, India-683582

Office: +91-484-2450330 Mob: +91-8714504684

Web: <http://www.scmsgroup.org/sset/computer-science-engineering/dr-varun-g-menon>



SCMS
School of Engineering & Technology

On Sun, Jun 24, 2018 at 12:56 AM, Dr. Varun G Menon
<varunmenon@scmsgroup.org> wrote:

Dear Mr. Syed Raihan-UI-Islam,

Thank you for the email. Will inform the Professor's in charge of the Cyber Security and Robotics research centers about the program plan. Will sent you the documents soon.

Have a Great Day.

Thanks and Regards,

Dr. Varun G Menon

Associate Professor-Computer Science Engineering
Exe. Officer-Corporate Relations & International Collaborations
SCMS School of Engineering and Technology
Kerala, India-683582

Office: +91-484-2450330 Mob: +91-8714504684

Web: <http://www.scmsgroup.org/sset/computer-science-engineering/dr-varun-g-menon>



SCMS
School of Engineering & Technology

On Sun, Jun 24, 2018 at 12:17 AM, International Affairs, DIU
<int@daffodilvarsity.edu.bd> wrote:

Dear Dr, Varun

Thank you very much for your quick response.

It would be great if you can share any proposal or program plan with all details, course plan, costing etc of the Summer internships based on Cyber Security and Robotics so that we could check and show t our students for interest.

Hope to receive the agreement and the program proposals soon. Have a great day !

- With best regards

Syed Raihan-UI-Islam

Senior Administrative Officer, International Affairs
Daffodil International University

102/1, Shukrabad, Dhanmondi, Dhaka-1207, Bangladesh.
Tel: **+88 02 9138234 (Ext: 237)** | Mob: **+88-01811458865**
WhatsApp/Viber/Wechat: **+88-01920012744**

On Sun, Jun 24, 2018 at 12:35 AM, Dr. Varun G Menon
<varunmenon@scmsgroup.org> wrote:

Dear Mr. Syed Raihan-UI-Islam,

Thank you for the information about Daffodil International University.
Will complete the agreement copy and send you at the earliest.

We have 5 active research groups in our Engineering College that include Centre for Robotics, Centre for Cyber Security, Hydrodynamics and Computational Fluid Dynamics, Antennas and Radiation, Centre for Sustainable Water Technology and Management. Students from your University can do summer internships and short term projects with these project groups.

Besides we also have one of the leading Management Institute in India and also Biotechnology Research Centre.

Thank you for the collaboration. Will send you the document soon.

Regards,

Dr. Varun G Menon

Associate Professor-Computer Science Engineering
Exe. Officer-Corporate Relations & International Collaborations
SCMS School of Engineering and Technology
Kerala, India-683582
Office: +91-484-2450330 Mob: +91-8714504684
Web: <http://www.scmsgroup.org/sset/computer-science-engineering/dr-varun-g-menon>



SCMS

School of Engineering & Technology

On Sat, Jun 23, 2018 at 6:42 PM, International Affairs, DIU
<int@daffodilvarsity.edu.bd> wrote:

Dear Dr. Varun G Menon,

Greetings from DIU!

Thanks for your email and showing interest in the academic partnership. Yes, we can collaborate in the areas of student exchange programs, faculty exchange programs, summer school research collaborations, joint seminars and conferences.

I have attached here the sample agreement copy of DIU, Could you please check and fill it with your information. Besides, I have attached here the fact sheet of DIU where you can check our common details and department.

Your CSE, ECE and EEE Department can be a good prospect between both universities. Let us know your observation

Looking forward to hearing from you soon.

- With best regards

Syed Raihan-UI-Islam

Senior Administrative Officer, International Affairs
Daffodil International University

102/1, Shukrabad, Dhanmondi, Dhaka-1207, Bangladesh.
Tel: **+88 02 9138234 (Ext: 237)** | Mob: **+88-01811458865**
WhatsApp/Viber/Wechat: **+88-01920012744**

Respected Mr. Salahuddin Morsalin

Thank you for your time and consideration. Let me introduce as Dr. Varun G Menon, in charge of International Collaborations at SCMS Group of Educational Institutions, India.

We are interested in having academic collaboration with Daffodil International University. Collaboration could be in the areas of student exchange programs, faculty exchange programs, research collaborations, joint seminars and conferences.

We have a dedicate team of faculty and students working in areas like Robotics, Brain Signal Analysis, Computational fluid dynamics. Water Quality Monitoring and Assessment, Limnology, Water Audit, Environmental Remote Sensing , Android Malware Analysis. Research collaborations in these areas is another possibility.

We have academic collaborations with leading international universities like Vrije University-Brussels, Furtwangen University-Germany, University of Applied Sciences Ravensburg Weingarten-Germany, Shimane University-Japan and more.

Please let me know if we could discuss and take forward this initiative.

For your information we are the No 1 ranked private educational institutions in the state. You can find more information about our institutions in www.scmsgroup.org and about our Engineering Institute in www.scmsgroup.org/sset/

Have a Great Day.

Thanks and Regards,

Dr. Varun G Menon

Associate Professor-Computer Science Engineering
Exe. Officer-Corporate Relations & International Collaborations
SCMS School of Engineering and Technology
Kerala, India-683582
Office: +91-484-2450330 Mob: +91-8714504684
Web: <http://www.scmsgroup.org/sset/computer-science-engineering/dr-varun-g-menon>



SCMS
School of Engineering & Technology

--
Thanks and Regards,

Dr. Varun G Menon

Associate Professor-Computer Science Engineering
Exe. Officer-Corporate Relations & International Collaborations
SCMS School of Engineering and Technology
Kerala, India-683582
Office: +91-484-2450330 Mob: +91-8714504684
Web: <http://www.scmsgroup.org/sset/computer-science-engineering/dr-varun-g-menon>



SCMS
School of Engineering & Technology

--
Thanks and Regards,

Dr. Varun G Menon
Associate Professor-Computer Science Engineering
Exe. Officer-Corporate Relations & International Collaborations
SCMS School of Engineering and Technology
Kerala, India-683582
Office: +91-484-2450330 Mob: +91-8714504684
Web: <http://www.scmsgroup.org/sset/computer-science-engineering/dr-varun-g-menon>



SCMS
School of Engineering & Technology

--
Thanks and Regards,

Dr. Varun G Menon
Associate Professor-Computer Science Engineering
Exe. Officer-Corporate Relations & International Collaborations
SCMS School of Engineering and Technology
Kerala, India-683582
Office: +91-484-2450330 Mob: +91-8714504684
Web: <http://www.scmsgroup.org/sset/computer-science-engineering/dr-varun-g-menon>



SCMS
School of Engineering & Technology

To: "International Affairs, DIU" <int@daffodilvarsity.edu.bd>
Cc: "Office of the International Affairs, DIU" <mobility@daffodilvarsity.edu.bd>, Scholarship News <scholarship@daffodilvarsity.edu.bd>, "International, DIU" <international@daffodilvarsity.edu.bd>, Emran Hossain <emran@daffodilvarsity.edu.bd>, "VC Office-2, DIU" <vcoffice2@daffodilvarsity.edu.bd>, Pramod <pramod@scmsgroup.org>, Anupama COK <anupama@scmsgroup.org>

Dear Mr. Syed Raihan-UI-Islam,
Thank you for the collaboration with SCMS.

Kindly see below the details of hotel reserved by us
Hotel Name: Best Western B/W La Vinci Hotel
Address: 54, Kawran Bazar, Dhaka, Bangladesh 1215

Please let me know if you would be arranging a pick up from the hotel to the DIU campus. We could start at 1.30 pm from the hotel to the DIU campus for the visit and signing of the MoU.

Thanks and Regards,

Dr. Varun G Menon
Associate Professor & Head of International Relations
SCMS Group of Educational Institutions
Cochin, Kerala, India-683106
Office: +91-484-2450330 Mob: +91-8714504684
Web: <http://www.scmsgroup.org>



On Mon, Jul 9, 2018 at 10:58 AM, International Affairs, DIU <int@daffodilvarsity.edu.bd> wrote:
Dear Dr. Varun,

Here is the address that i already gave you in whatsapp:

[Daffodil International University](#)
102/1, Shukrabad, Dhanmondi, Dhaka-1207
Bangladesh

some hotels nearby our campus:

<http://www.ambalainn.com>

<https://www.panpacific.com/en/hotels-and-resorts/pp-dhaka.html>

- *With best regards*

Syed Raihan-UI-Islam
Senior Administrative Officer, International Affairs
Daffodil International University
102/1, Shukrabad, Dhanmondi, Dhaka-1207, Bangladesh.
Tel: **+88 02 9138234 (Ext: 237)** | Mob: **+88-01811458865**
WhatsApp/Viber/Wechat: **+88-01920012744**

On Thu, Jul 5, 2018 at 5:25 PM, Dr. Varun G Menon <varunmenon@scmsgroup.org> wrote:

Dear Mr. Syed Raihan-UI-Islam,

Thank you for the collaboration with SCMS. Please let us know the campus address of DIU where the visit and MoU signing ceremony is planned so that we could arrange the stay in a hotel near the campus. We could see multiple campuses of DIU in the website. It would also be great if you could give the names of few good hotels near your campus.

Thanks and Regards,

Dr. Varun G Menon
Associate Professor, Computer Science Engineering
Exe. Officer, Corporate Relations & International Collaborations
SCMS School of Engineering and Technology

Kerala, India-683582

Office: +91-484-2450330 Mob: +91-8714504684

Web: <http://www.scmsgroup.org/sset/computer-science-engineering/dr-varun-g-menon>



SCMS
School of Engineering & Technology

On Tue, Jul 3, 2018 at 5:04 PM, International Affairs, DIU <int@daffodilvarsity.edu.bd> wrote:

Dear Dr. Varun

Yes Confirm so far. Thank You

- With best regards

Syed Raihan-UI-Islam

Senior Administrative Officer, International Affairs

Daffodil Internersity

102/1, Shukrabad, Dhanmondi, Dhaka-1207, Bangladesh.

Tel: **+88 02 9138234 (Ext: 237)** | Mob: **+88-01811458865**

WhatsApp/Viber/Wechat: **+88-01920012744**

On Tue, Jul 3, 2018 at 3:57 AM, Dr. Varun G Menon <varunmenon@scmsgroup.org> wrote:

Dear Mr. Syed Raihan-UI-Islam

Thank you for the valuable time. Please confirm the schedule as discussed and agreed earlier. No need to change the schedule. Our flight is scheduled only in the night.

- MoU Signing Ceremony and discussion session on **25th July 2018** from **3PM to 5PM**
- Visit to DIU Permanent Campus and Lunch on the on that day **9AM to 2PM**

Thanks and Regards,

Dr. Varun G Menon

Associate Professor, Computer Science Engineering

Exe. Officer, Corporate Relations & International Collaborations

SCMS School of Engineering and Technology

Kerala, India-683582

Office: +91-484-2450330 Mob: +91-8714504684

Web: <http://www.scmsgroup.org/sset/computer-science-engineering/dr-varun-g-menon>



SCMS
School of Engineering & Technology

On Sun, Jul 1, 2018 at 12:09 PM, Dr. Varun G Menon <varunmenon@scmsgroup.org> wrote:

Dear Mr. Syed Raihan-UI-Islam,

Please let me know if you can arrange the MoU signing ceremony and discussion on collaboration at DIU on **25th July morning** as we have flight back to India in the evening.

Thank you,

Dr. Varun G Menon

Associate Professor-Computer Science Engineering

Exe. Officer-Corporate Relations & International Collaborations

SCMS School of Engineering and Technology

Kerala, India-683582

Office: +91-484-2450330 Mob: +91-8714504684

Web: <http://www.scmsgroup.org/sset/computer-science-engineering/dr-varun-g-menon>



SCMS
School of Engineering & Technology

On Thu, Jun 28, 2018 at 1:32 PM, Dr. Varun G Menon <varunmenon@scmsgroup.org> wrote:

Dear Mr. Syed Raihan-UI-Islam,

Thank you for the invitation letter. Looking forward to the meeting. Will update our schedule once we confirm the flight tickets.

Thanks and Regards,

Dr. Varun G Menon

Associate Professor-Computer Science Engineering

Exe. Officer-Corporate Relations & International Collaborations

SCMS School of Engineering and Technology

Kerala, India-683582

Office: +91-484-2450330 Mob: +91-8714504684

Web: <http://www.scmsgroup.org/sset/computer-science-engineering/dr-varun-g-menon>



SCMS
School of Engineering & Technology

On Thu, Jun 28, 2018 at 1:09 PM, International Affairs, DIU <int@daffodilvarsity.edu.bd> wrote:

Dear Dr. Varun

Please find the attached letter of Invitation for both of you to visit us for the purpose of the meeting and signing the agreement.

- With best regards

Syed Raihan-UI-Islam

Senior Administrative Officer, International Affairs

Daffodil International University

102/1, Shukrabad, Dhanmondi, Dhaka-1207, Bangladesh.

Tel: **+88 02 9138234 (Ext: 237)** | Mob: **+88-01811458865**

WhatsApp/Viber/Wechat: **+88-01920012744**

On Thu, Jun 28, 2018 at 8:20 AM, Dr. Varun G Menon <varunmenon@scmsgroup.org> wrote:

Dear Mr. Syed Raihan-UI-Islam,

Please see below the details of members visiting DIU on 25th July 2018. Please send us the **invitation letter for the Visa** based on this information.

Names

Prof. **PRAMOD PRATHAPACHANDRAN THEVANNOOR**, Vice Chairman, SCMS Group of Educational Institutions.

Dr. **VARUN GIRIJAN MENON**, Associate Professor and International Relations in-charge, SCMS Group of Educational Institutions.

Address

SCMS Group of Educational Institutions

SCMS Campus, Prathap Nagar

Muttom, Aluva

Cochin – 683 106, Kerala, INDIA

Let me know any further information required.

Thanks and Regards,

Dr. Varun G Menon

Associate Professor-Computer Science Engineering
Exe. Officer-Corporate Relations & International Collaborations
SCMS School of Engineering and Technology
Kerala, India-683582
Office: +91-484-2450330 Mob: +91-8714504684
Web: <http://www.scmsgroup.org/sset/computer-science-engineering/dr-varun-g-menon>



SCMS
School of Engineering & Technology

On Wed, Jun 27, 2018 at 11:48 AM, International Affairs, DIU <int@daffodilvarsity.edu.bd> wrote:
Dear Dr. Varun

Thanks. I am looking forward.

- With best regards

Syed Raihan-UI-Islam

Senior Administrative Officer, International Affairs
Daffodil International University
102/1, Shukrabad, Dhanmondi, Dhaka-1207, Bangladesh.
Tel: **+88 02 9138234 (Ext: 237)** | Mob: **+88-01811458865**
WhatsApp/Viber/Wechat: **+88-01920012744**

On Wed, Jun 27, 2018 at 12:15 PM, Dr. Varun G Menon <varunmenon@scmsgroup.org> wrote:
Dear Mr. Syed Raihan-UI-Islam,
Thank you for the information. We will have the visit on 25th July. We will send the details of the members visiting the DIU campus at the earliest.
Regards
Varun

On Wednesday, June 27, 2018, International Affairs, DIU <int@daffodilvarsity.edu.bd> wrote:
Dear Dr. Varun,

I have discussed with the Office of the Vice Chancellor

We can arrange the MoU Signing Ceremony and discussion session on **25 July 2018** from **3PM to 5PM**
We can also arrange to visit our Permanent Campus and Lunch on the on that day 9AM to 2PM too.

Let us know if the time and date is convenient for your visit

Looking forward to hearing from you.

- With best regards

Syed Raihan-UI-Islam

Senior Administrative Officer, International Affairs
Daffodil International University
102/1, Shukrabad, Dhanmondi, Dhaka-1207, Bangladesh.
Tel: **+88 02 9138234 (Ext: 237)** | Mob: **+88-01811458865**
WhatsApp/Viber/Wechat: **+88-01920012744**

On Wed, Jun 27, 2018 at 11:18 AM, Dr. Varun G Menon <varunmenon@scmsgroup.org> wrote:
Dear Mr. Syed Raihan-UI-Islam,
Can we have the visit between July 24 and 27. Our Vice Chairman is traveling on other dates in July.
Please let me know.

Varun

On Wednesday, June 27, 2018, International Affairs, DIU <int@daffodilvarsity.edu.bd> wrote:
Dear Dr. Varun

Can we shift it to the next week I mean in between 15 to 20 July?

- *With best regards*

Syed Raihan-UI-Islam

Senior Administrative Officer, International Affairs

Daffodil International University

102/1, Shukrabad, Dhanmondi, Dhaka-1207, Bangladesh.

Tel: **+88 02 9138234 (Ext: 237)** | Mob: **+88-01811458865**

WhatsApp/Viber/Wechat: **+88-01920012744**

On Wed, Jun 27, 2018 at 10:55 AM, Dr. Varun G Menon <varunmenon@scmsgroup.org> wrote:

Dear Mr. Syed Raihan-UI-Islam,

Thank you for the message. We would like to visit DIU between 10th and 14th July. Please let us know if the date is convenient at your end. Also it would be great if you could send us an Invitation letter which could be produced for the Visa.

Let me know any further details required.

Varun

On Tuesday, June 26, 2018, International Affairs, DIU <int@daffodilvarsity.edu.bd> wrote:

Dear Dr. Varun

That is a good idea. Let us know your possible dates to visit us and sign the agreement between both of the universities.

- *With best regards*

Syed Raihan-UI-Islam

Senior Administrative Officer, International Affairs

Daffodil International University

102/1, Shukrabad, Dhanmondi, Dhaka-1207, Bangladesh.

Tel: **+88 02 9138234 (Ext: 237)** | Mob: **+88-01811458865**

WhatsApp/Viber/Wechat: **+88-01920012744**

On Tue, Jun 26, 2018 at 10:38 PM, Dr. Varun G Menon <varunmenon@scmsgroup.org> wrote:

Dear Mr. Syed Raihan-UI-Islam,

Thank you for the collaboration with SCMS. We would like to visit the DIU campus on a favorable date and would like to sign the MoU with the Vice Chancellor at DIU. We would be more than happy to host the DIU team with Vice Chancellor in our campus in future. Please let me know your thoughts.

Thanks and Regards,

Dr. Varun G Menon

Associate Professor-Computer Science Engineering

Exe. Officer-Corporate Relations & International Collaborations

SCMS School of Engineering and Technology

Kerala, India-683582

Office: +91-484-2450330 Mob: +91-8714504684

Web: <http://www.scmsgroup.org/sset/computer-science-engineering/dr-varun-g-menon>



SCMS

School of Engineering & Technology

On Tue, Jun 26, 2018 at 6:54 PM, International Affairs, DIU <int@daffodilvarsity.edu.bd> wrote:

Dear Dr. Varun

Thank you very much for the agreement final copy. It's fine

May I request you to sign the agreement and send the copies to me either scan copy in my email or 2 original copies in my address given in my email signature

- *With best regards*

Syed Raihan-UI-Islam

Senior Administrative Officer, International Affairs
Daffodil International University

102/1, Shukrabad, Dhanmondi, Dhaka-1207, Bangladesh.

Tel: **+88 02 9138234 (Ext: 237)** | Mob: **+88-01811458865**

WhatsApp/Viber/Wechat: **+88-01920012744**

On Tue, Jun 26, 2018 at 7:01 PM, Dr. Varun G Menon <varunmenon@scmsgroup.org> wrote:

Dear Mr. Syed Raihan-UI-Islam,

Thank you for the collaboration with SCMS. Please see the attached MoU draft approved by our Vice Chairman. Please let me know the remaining procedures including the signing of the MoU.

Thanks and Regards,

Dr. Varun G Menon

Associate Professor-Computer Science Engineering

Exe. Officer-Corporate Relations & International Collaborations

SCMS School of Engineering and Technology

Kerala, India-683582

Office: +91-484-2450330 Mob: +91-8714504684

Web: <http://www.scmsgroup.org/sset/computer-science-engineering/dr-varun-g-menon>



SCMS

School of Engineering & Technology

On Mon, Jun 25, 2018 at 3:55 PM, International Affairs, DIU <int@daffodilvarsity.edu.bd> wrote:

Dear Dr. Varun

Thank you so much for your email and letting us know the update.

- *With best regards*

Syed Raihan-UI-Islam

Senior Administrative Officer, International Affairs
Daffodil International University

102/1, Shukrabad, Dhanmondi, Dhaka-1207, Bangladesh.

Tel: **+88 02 9138234 (Ext: 237)** | Mob: **+88-01811458865**

WhatsApp/Viber/Wechat: **+88-01920012744**

On Mon, Jun 25, 2018 at 4:14 PM, Dr. Varun G Menon <varunmenon@scmsgroup.org> wrote:

Dear Mr. Syed Raihan-UI-Islam,

Thank you for the collaboration with SCMS. I have presented the MoU with the Vice Chairman for approval. Once the approval is obtained, I will send back the approved soft copy of the MoU.

I have discussed about the Short Term Internships for students from DIU at the Centre for Robotics, SCMS with the Director, Robotics Lab. He has promised to send me The Best Plan for DIU students within two days. I will send you the same at the earliest.

Thanks and Regards,

Dr. Varun G Menon

Associate Professor-Computer Science Engineering
Exe. Officer-Corporate Relations & International Collaborations
SCMS School of Engineering and Technology
Kerala, India-683582
Office: +91-484-2450330 Mob: +91-8714504684
Web: <http://www.scmsgroup.org/sset/computer-science-engineering/dr-varun-g-menon>



On Sun, Jun 24, 2018 at 12:56 AM, Dr. Varun G Menon
<varunmenon@scmsgroup.org> wrote:

Dear Mr. Syed Raihan-UI-Islam,

Thank you for the email. Will inform the Professor's in charge of the Cyber Security and Robotics research centers about the program plan. Will sent you the documents soon.

Have a Great Day.

Thanks and Regards,

Dr. Varun G Menon

Associate Professor-Computer Science Engineering
Exe. Officer-Corporate Relations & International Collaborations
SCMS School of Engineering and Technology
Kerala, India-683582
Office: +91-484-2450330 Mob: +91-8714504684
Web: <http://www.scmsgroup.org/sset/computer-science-engineering/dr-varun-g-menon>



On Sun, Jun 24, 2018 at 12:17 AM, International Affairs, DIU
<int@daffodilvarsity.edu.bd> wrote:

Dear Dr, Varun

Thank you very much for your quick response.

It would be great if you can share any proposal or program plan with all details, course plan, costing etc of the Summer internships based on Cyber Security and Robotics so that we could check and show t our students for interest.

Hope to receive the agreement and the program proposals soon. Have a great day !

- With best regards

Syed Raihan-UI-Islam

Senior Administrative Officer, International Affairs
Daffodil International University

102/1, Shukrabad, Dhanmondi, Dhaka-1207, Bangladesh.

Tel: +88 02 9138234 (Ext: 237) | Mob: +88-01811458865

WhatsApp/Viber/Wechat: +88-01920012744

On Sun, Jun 24, 2018 at 12:35 AM, Dr. Varun G Menon

<varunmenon@scmsgroup.org> wrote:

Dear Mr. Syed Raihan-UI-Islam,

Thank you for the information about Daffodil International University. Will complete the agreement copy and send you at the earliest.

We have 5 active research groups in our Engineering College that include Centre for Robotics, Centre for Cyber Security, Hydrodynamics and Computational Fluid Dynamics, Antennas and Radiation, Centre for Sustainable Water Technology and Management. Students from your University can do summer internships and short term projects with these project groups.

Besides we also have one of the leading Management Institute in India and also Biotechnology Research Centre.

Thank you for the collaboration. Will send you the document soon.

Regards,

Dr. Varun G Menon

Associate Professor-Computer Science Engineering

Exe. Officer-Corporate Relations & International Collaborations

SCMS School of Engineering and Technology

Kerala, India-683582

Office: +91-484-2450330 Mob: +91-8714504684

Web: <http://www.scmsgroup.org/sset/computer-science-engineering/dr-varun-g-menon>



SCMS

School of Engineering & Technology

On Sat, Jun 23, 2018 at 6:42 PM, International Affairs, DIU

<int@daffodilvarsity.edu.bd> wrote:

Dear Dr. Varun G Menon,

Greetings from DIU!

Thanks for your email and showing interest in the academic partnership. Yes, we can collaborate in the areas of student exchange programs, faculty exchange programs, summer school research collaborations, joint seminars and conferences.

I have attached here the sample agreement copy of DIU, Could you please check and fill it with your information. Besides, I have attached here the fact sheet of DIU where you can check our common details and department.

Your CSE, ECE and EEE Department can be a good prospect between both universities. Let us know your observation

Looking forward to hearing from you soon.

- With best regards

Syed Raihan-UI-Islam

Senior Administrative Officer, International Affairs

Daffodil International University

102/1, Shukrabad, Dhanmondi, Dhaka-1207, Bangladesh.

Tel: **+88 02 9138234 (Ext: 237)** | Mob: **+88-01811458865**
WhatsApp/Viber/Wechat: **+88-01920012744**

Respected Mr. Salahuddin Morsalin

Thank you for your time and consideration. Let me introduce as Dr. Varun G Menon, in charge of International Collaborations at SCMS Group of Educational Institutions, India.

We are interested in having academic collaboration with Daffodil International University. Collaboration could be in the areas of student exchange programs, faculty exchange programs, research collaborations, joint seminars and conferences.

We have a dedicate team of faculty and students working in areas like Robotics, Brain Signal Analysis, Computational fluid dynamics, Water Quality Monitoring and Assessment, Limnology, Water Audit, Environmental Remote Sensing , Android Malware Analysis. Research collaborations in these areas is another possibility.

We have academic collaborations with leading international universities like Vrije University-Brussels, Furtwangen University-Germany, University of Applied Sciences Ravensburg Weingarten-Germany, Shimane University-Japan and more.

Please let me know if we could discuss and take forward this initiative.

For your information we are the No 1 ranked private educational institutions in the state. You can find more information about our institutions in www.scmsgroup.org and about our Engineering Institute in www.scmsgroup.org/sset/

Have a Great Day.

Thanks and Regards,

Dr. Varun G Menon

Associate Professor-Computer Science Engineering
Exe. Officer-Corporate Relations & International
Collaborations

SCMS School of Engineering and Technology
Kerala, India-683582

Office: +91-484-2450330 Mob: +91-8714504684

Web: <http://www.scmsgroup.org/sset/computer-science-engineering/dr-varun-g-menon>



SCMS

School of Engineering & Technology

Thanks and Regards,

Dr. Varun G Menon

Associate Professor-Computer Science Engineering
Exe. Officer-Corporate Relations & International Collaborations
SCMS School of Engineering and Technology
Kerala, India-683582
Office: +91-484-2450330 Mob: +91-8714504684
Web: <http://www.scmsgroup.org/sset/computer-science-engineering/dr-varun-g-menon>



--
Thanks and Regards,

Dr. Varun G Menon

Associate Professor-Computer Science Engineering
Exe. Officer-Corporate Relations & International Collaborations
SCMS School of Engineering and Technology
Kerala, India-683582
Office: +91-484-2450330 Mob: +91-8714504684
Web: <http://www.scmsgroup.org/sset/computer-science-engineering/dr-varun-g-menon>



--
Thanks and Regards,

Dr. Varun G Menon

Associate Professor-Computer Science Engineering
Exe. Officer-Corporate Relations & International Collaborations
SCMS School of Engineering and Technology
Kerala, India-683582
Office: +91-484-2450330 Mob: +91-8714504684
Web: <http://www.scmsgroup.org/sset/computer-science-engineering/dr-varun-g-menon>



International Affairs, DIU <int@daffodilvarsity.edu.bd> Fri, Jul 13, 2018 at 1:21 PM
To: "Dr. Varun G Menon" <varunmenon@scmsgroup.org>
Cc: "Office of the International Affairs, DIU" <mobility@daffodilvarsity.edu.bd>, Scholarship News <scholarship@daffodilvarsity.edu.bd>, "International, DIU" <international@daffodilvarsity.edu.bd>, Emran Hossain <emran@daffodilvarsity.edu.bd>, "VC Office-2, DIU" <vcoffice2@daffodilvarsity.edu.bd>, Pramod <pramod@scmsgroup.org>, Anupama COK <anupama@scmsgroup.org>

Dear Dr. Varun

Yes we will arrange pick and drop for you and your Vice Chairman

- *With best regards*

Syed Raihan-UI-Islam

Senior Administrative Officer, International Affairs

Daffodil International University

102/1, Shukrabad, Dhanmondi, Dhaka-1207, Bangladesh.

Tel: **+88 02 9138234 (Ext: 237)** | Mob: **+88-01811458865**

WhatsApp/Viber/Wechat: **+88-01920012744**

On Thu, Jul 12, 2018 at 9:58 PM, Dr. Varun G Menon <varunmenon@scmsgroup.org> wrote:

Dear Mr. Syed Raihan-UI-Islam,

Thank you for the collaboration with SCMS.

Kindly see below the details of hotel reserved by us

Hotel Name: Best Western B/W La Vinci Hotel

Address: 54, Kawran Bazar, Dhaka, Bangladesh 1215

Please let me know if you would be arranging a pick up from the hotel to the DIU campus. We could start at 1.30 pm from the hotel to the DIU campus for the visit and signing of the MoU.

Thanks and Regards,

Dr. Varun G Menon

Associate Professor & Head of International Relations

SCMS Group of Educational Institutions

Cochin, Kerala, India-683106

Office: +91-484-2450330 Mob: +91-8714504684

Web: <http://www.scmsgroup.org>



SCMS

GROUP OF EDUCATIONAL INSTITUTIONS

On Mon, Jul 9, 2018 at 10:58 AM, International Affairs, DIU <int@daffodilvarsity.edu.bd> wrote:

Dear Dr. Varun,

Here is the address that i already gave you in whatsapp:

[Daffodil International University](#)
102/1, Shukrabad, Dhanmondi, Dhaka-1207
Bangladesh

some hotels nearby our campus:

<http://www.ambalainn.com>

<https://www.panpacific.com/en/hotels-and-resorts/pp-dhaka.html>

- *With best regards*

Syed Raihan-UI-Islam

Senior Administrative Officer, International Affairs
Daffodil International University
 102/1, Shukrabad, Dhanmondi, Dhaka-1207, Bangladesh.
 Tel: **+88 02 9138234 (Ext: 237)** | Mob: **+88-01811458865**
 WhatsApp/Viber/Wechat: **+88-01920012744**

On Thu, Jul 5, 2018 at 5:25 PM, Dr. Varun G Menon <varunmenon@scmsgroup.org> wrote:

Dear Mr. Syed Raihan-UI-Islam,

Thank you for the collaboration with SCMS. Please let us know the campus address of DIU where the visit and MoU signing ceremony is planned so that we could arrange the stay in a hotel near the campus. We could see multiple campuses of DIU in the website. It would also be great if you could give the names of few good hotels near your campus.

Thanks and Regards,

Dr. Varun G Menon

Associate Professor, Computer Science Engineering
 Exe. Officer, Corporate Relations & International Collaborations
 SCMS School of Engineering and Technology
 Kerala, India-683582
 Office: +91-484-2450330 Mob: +91-8714504684
 Web: <http://www.scmsgroup.org/sset/computer-science-engineering/dr-varun-g-menon>



SCMS
 School of Engineering & Technology

On Tue, Jul 3, 2018 at 5:04 PM, International Affairs, DIU <int@daffodilvarsity.edu.bd> wrote:

Dear Dr. Varun

Yes Confirm so far. Thank You

- With best regards

Syed Raihan-UI-Islam

Senior Administrative Officer, International Affairs
Daffodil International University
 102/1, Shukrabad, Dhanmondi, Dhaka-1207, Bangladesh.
 Tel: **+88 02 9138234 (Ext: 237)** | Mob: **+88-01811458865**
 WhatsApp/Viber/Wechat: **+88-01920012744**

On Tue, Jul 3, 2018 at 3:57 AM, Dr. Varun G Menon <varunmenon@scmsgroup.org> wrote:

Dear Mr. Syed Raihan-UI-Islam

Thank you for the valuable time. Please confirm the schedule as discussed and agreed earlier. No need to change the schedule. Our flight is scheduled only in the night.

- MoU Signing Ceremony and discussion session on **25th July 2018** from **3PM to 5PM**
- Visit to DIU Permanent Campus and Lunch on the on that day **9AM to 2PM**

Thanks and Regards,

Dr. Varun G Menon

Associate Professor, Computer Science Engineering
 Exe. Officer, Corporate Relations & International Collaborations
 SCMS School of Engineering and Technology
 Kerala, India-683582
 Office: +91-484-2450330 Mob: +91-8714504684
 Web: <http://www.scmsgroup.org/sset/computer-science-engineering/dr-varun-g-menon>



SCMS
 School of Engineering & Technology

On Sun, Jul 1, 2018 at 12:09 PM, Dr. Varun G Menon <varunmenon@scmsgroup.org> wrote:

Dear Mr. Syed Raihan-UI-Islam,

Please let me know if you can arrange the MoU signing ceremony and discussion on collaboration at DIU on **25th July morning** as we have flight back to India in the evening.

Thank you,

Dr. Varun G Menon

Associate Professor-Computer Science Engineering
Exe. Officer-Corporate Relations & International Collaborations
SCMS School of Engineering and Technology
Kerala, India-683582
Office: +91-484-2450330 Mob: +91-8714504684
Web: <http://www.scmsgroup.org/sset/computer-science-engineering/dr-varun-g-memon>



SCMS
School of Engineering & Technology

On Thu, Jun 28, 2018 at 1:32 PM, Dr. Varun G Menon <varunmenon@scmsgroup.org> wrote:

Dear Mr. Syed Raihan-UI-Islam,

Thank you for the invitation letter. Looking forward to the meeting. Will update our schedule once we confirm the flight tickets.

Thanks and Regards,

Dr. Varun G Menon

Associate Professor-Computer Science Engineering
Exe. Officer-Corporate Relations & International Collaborations
SCMS School of Engineering and Technology
Kerala, India-683582
Office: +91-484-2450330 Mob: +91-8714504684
Web: <http://www.scmsgroup.org/sset/computer-science-engineering/dr-varun-g-memon>



SCMS
School of Engineering & Technology

On Thu, Jun 28, 2018 at 1:09 PM, International Affairs, DIU <int@daffodilvarsity.edu.bd> wrote:

Dear Dr. Varun

Please find the attached letter of Invitation for both of you to visit us for the purpose of the meeting and signing the agreement.

- With best regards

Syed Raihan-UI-Islam

Senior Administrative Officer, International Affairs
Daffodil International University
102/1, Shukrabad, Dhanmondi, Dhaka-1207, Bangladesh.
Tel: **+88 02 9138234 (Ext: 237)** | Mob: **+88-01811458865**
WhatsApp/Viber/Wechat: **+88-01920012744**

On Thu, Jun 28, 2018 at 8:20 AM, Dr. Varun G Menon <varunmenon@scmsgroup.org> wrote:

Dear Mr. Syed Raihan-UI-Islam,

Please see below the details of members visiting DIU on 25th July 2018. Please send us the **invitation letter for the Visa** based on this information.

Names

Prof. **PRAMOD PRATHAPACHANDRAN THEVANNOOR**, Vice Chairman, SCMS Group of Educational Institutions.

Dr. **VARUN GIRIJAN MENON**, Associate Professor and International Relations in-charge, SCMS Group of Educational Institutions.

Address

SCMS Group of Educational Institutions
SCMS Campus, Prathap Nagar
Muttom, Aluva
Cochin – 683 106, Kerala, INDIA

Let me know any further information required.

Thanks and Regards,

Dr. Varun G Menon

Associate Professor-Computer Science Engineering
Exe. Officer-Corporate Relations & International Collaborations
SCMS School of Engineering and Technology
Kerala, India-683582
Office: +91-484-2450330 Mob: +91-8714504684
Web: <http://www.scmsgroup.org/sset/computer-science-engineering/dr-varun-g-menon>



SCMS
School of Engineering & Technology

On Wed, Jun 27, 2018 at 11:48 AM, International Affairs, DIU <int@daffodilvarsity.edu.bd> wrote:
Dear Dr. Varun

Thanks. I am looking forward.

- With best regards

Syed Raihan-UI-Islam

Senior Administrative Officer, International Affairs

Daffodil International University

102/1, Shukrabad, Dhanmondi, Dhaka-1207, Bangladesh.

Tel: **+88 02 9138234 (Ext: 237)** | Mob: **+88-01811458865**

WhatsApp/Viber/Wechat: **+88-01920012744**

On Wed, Jun 27, 2018 at 12:15 PM, Dr. Varun G Menon <varunmenon@scmsgroup.org> wrote:

Dear Mr. Syed Raihan-UI-Islam,

Thank you for the information. We will have the visit on 25th July. We will send the details of the members visiting the DIU campus at the earliest.

Regards

Varun

On Wednesday, June 27, 2018, International Affairs, DIU <int@daffodilvarsity.edu.bd> wrote:

Dear Dr. Varun,

I have discussed with the Office of the Vice Chancellor

We can arrange the MoU Signing Ceremony and discussion session on **25 July 2018** from **3PM to 5PM**

We can also arrange to visit our Permanent Campus and Lunch on the on that day 9AM to 2PM too.

Let us know if the time and date is convenient for your visit

Looking forward to hearing from you.

- With best regards

Syed Raihan-UI-Islam

Senior Administrative Officer, International Affairs

Daffodil International University

102/1, Shukrabad, Dhanmondi, Dhaka-1207, Bangladesh.

Tel: **+88 02 9138234 (Ext: 237)** | Mob: **+88-01811458865**

WhatsApp/Viber/Wechat: **+88-01920012744**

On Wed, Jun 27, 2018 at 11:18 AM, Dr. Varun G Menon <varunmenon@scmsgroup.org> wrote:

Dear Mr. Syed Raihan-UI-Islam,

Can we have the visit between July 24 and 27. Our Vice Chairman is traveling on other dates in July.

Please let me know.

Varun

On Wednesday, June 27, 2018, International Affairs, DIU <int@daffodilvarsity.edu.bd> wrote:

Dear Dr. Varun

Can we shift it to the next week I mean in between 15 to 20 July?

- With best regards

Syed Raihan-UI-Islam

Senior Administrative Officer, International Affairs

Daffodil International University

102/1, Shukrabad, Dhanmondi, Dhaka-1207, Bangladesh.

Tel: **+88 02 9138234 (Ext: 237)** | Mob: **+88-01811458865**

WhatsApp/Viber/Wechat: **+88-01920012744**

On Wed, Jun 27, 2018 at 10:55 AM, Dr. Varun G Menon <varunmenon@scmsgroup.org> wrote:

Dear Mr. Syed Raihan-UI-Islam,

Thank you for the message. We would like to visit DIU between 10th and 14th July. Please let us know if the date is convenient at your end. Also it would be great if you could send us an Invitation letter which could be produced for the Visa.

Let me know any further details required.

Varun

On Tuesday, June 26, 2018, International Affairs, DIU <int@daffodilvarsity.edu.bd> wrote:

Dear Dr. Varun

That is a good idea. Let us know your possible dates to visit us and sign the agreement between both of the universities.

- With best regards

Syed Raihan-UI-Islam

Senior Administrative Officer, International Affairs

Daffodil International University

102/1, Shukrabad, Dhanmondi, Dhaka-1207, Bangladesh.

Tel: **+88 02 9138234 (Ext: 237)** | Mob: **+88-01811458865**

WhatsApp/Viber/Wechat: **+88-01920012744**

On Tue, Jun 26, 2018 at 10:38 PM, Dr. Varun G Menon <varunmenon@scmsgroup.org> wrote:

Dear Mr. Syed Raihan-UI-Islam,

Thank you for the collaboration with SCMS. We would like to visit the DIU campus on a favorable date and would like to sign the MoU with the Vice Chancellor at DIU.

We would be more than happy to host the DIU team with Vice Chancellor in our campus in future. Please let me know your thoughts.

Thanks and Regards,

Dr. Varun G Menon

Associate Professor-Computer Science Engineering
Exe. Officer-Corporate Relations & International Collaborations
SCMS School of Engineering and Technology
Kerala, India-683582
Office: +91-484-2450330 Mob: +91-8714504684
Web: <http://www.scmsgroup.org/sset/computer-science-engineering/dr-varun-g-menon>



SCMS
School of Engineering & Technology

On Tue, Jun 26, 2018 at 6:54 PM, International Affairs, DIU
<int@daffodilvarsity.edu.bd> wrote:

Dear Dr. Varun

Thank you very much for the agreement final copy. It's fine

May I request you to sign the agreement and send the copies to me either scan copy in my email or 2 original copies in my address given in my email signature

- With best regards

Syed Raihan-UI-Islam

Senior Administrative Officer, International Affairs
Daffodil International University

102/1, Shukrabad, Dhanmondi, Dhaka-1207, Bangladesh.

Tel: **+88 02 9138234 (Ext: 237)** | Mob: **+88-01811458865**

WhatsApp/Viber/Wechat: **+88-01920012744**

On Tue, Jun 26, 2018 at 7:01 PM, Dr. Varun G Menon
<varunmenon@scmsgroup.org> wrote:

Dear Mr. Syed Raihan-UI-Islam,

Thank you for the collaboration with SCMS. Please see the attached MoU draft approved by our Vice Chairman. Please let me know the remaining procedures including the signing of the MoU.

Thanks and Regards,

Dr. Varun G Menon

Associate Professor-Computer Science Engineering
Exe. Officer-Corporate Relations & International Collaborations
SCMS School of Engineering and Technology
Kerala, India-683582

Office: +91-484-2450330 Mob: +91-8714504684

Web: <http://www.scmsgroup.org/sset/computer-science-engineering/dr-varun-g-menon>



SCMS
School of Engineering & Technology

On Mon, Jun 25, 2018 at 3:55 PM, International Affairs, DIU
<int@daffodilvarsity.edu.bd> wrote:

Dear Dr. Varun

Thank you so much for your email and letting us know the update.

- With best regards

Syed Raihan-UI-Islam

Senior Administrative Officer, International Affairs

Daffodil International University

102/1, Shukrabad, Dhanmondi, Dhaka-1207, Bangladesh.

Tel: +88 02 9138234 (Ext: 237) | Mob: +88-01811458865

WhatsApp/Viber/Wechat: +88-01920012744

On Mon, Jun 25, 2018 at 4:14 PM, Dr. Varun G Menon

<varunmenon@scmsgroup.org> wrote:

Dear Mr. Syed Raihan-UI-Islam,

Thank you for the collaboration with SCMS. I have presented the MoU with the Vice Chairman for approval. Once the approval is obtained, I will send back the approved soft copy of the MoU.

I have discussed about the Short Term Internships for students from DIU at the Centre for Robotics, SCMS with the Director, Robotics Lab. He has promised to send me The Best Plan for DIU students within two days. I will send you the same at the earliest.

Thanks and Regards,

Dr. Varun G Menon

Associate Professor-Computer Science Engineering

Exe. Officer-Corporate Relations & International Collaborations

SCMS School of Engineering and Technology

Kerala, India-683582

Office: +91-484-2450330 Mob: +91-8714504684

Web: <http://www.scmsgroup.org/sset/computer-science-engineering/dr-varun-g-menon>



SCMS

School of Engineering & Technology

On Sun, Jun 24, 2018 at 12:56 AM, Dr. Varun G Menon

<varunmenon@scmsgroup.org> wrote:

Dear Mr. Syed Raihan-UI-Islam,

Thank you for the email. Will inform the Professor's in charge of the Cyber Security and Robotics research centers about the program plan. Will sent you the documents soon.

Have a Great Day.

Thanks and Regards,

Dr. Varun G Menon

Associate Professor-Computer Science Engineering

Exe. Officer-Corporate Relations & International Collaborations

SCMS School of Engineering and Technology

Kerala, India-683582

Office: +91-484-2450330 Mob: +91-8714504684

Web: <http://www.scmsgroup.org/sset/computer-science-engineering/dr-varun-g-menon>



SCMS

School of Engineering & Technology

On Sun, Jun 24, 2018 at 12:17 AM, International Affairs, DIU

<int@daffodilvarsity.edu.bd> wrote:

Dear Dr, Varun

Thank you very much for your quick response.

It would be great if you can share any proposal or program plan with all details, course plan, costing etc of the Summer internships based on Cyber Security and Robotics so that we could check and show t our students for interest.

Hope to receive the agreement and the program proposals soon. Have a great day !

- With best regards

Syed Raihan-UI-Islam

Senior Administrative Officer, International Affairs

Daffodil International University

102/1, Shukrabad, Dhanmondi, Dhaka-1207, Bangladesh.

Tel: **+88 02 9138234 (Ext: 237)** | Mob: **+88-01811458865**

WhatsApp/Viber/Wechat: **+88-01920012744**

On Sun, Jun 24, 2018 at 12:35 AM, Dr. Varun G Menon

<varunmenon@scmsgroup.org> wrote:

Dear Mr. Syed Raihan-UI-Islam,

Thank you for the information about Daffodil International University. Will complete the agreement copy and send you at the earliest.

We have 5 active research groups in our Engineering College that include Centre for Robotics, Centre for Cyber Security, Hydrodynamics and Computational Fluid Dynamics, Antennas and Radiation, Centre for Sustainable Water Technology and Management. Students from your University can do summer internships and short term projects with these project groups.

Besides we also have one of the leading Management Institute in India and also Biotechnology Research Centre.

Thank you for the collaboration. Will send you the document soon.

Regards,

Dr. Varun G Menon

Associate Professor-Computer Science Engineering

Exe. Officer-Corporate Relations & International Collaborations

SCMS School of Engineering and Technology

Kerala, India-683582

Office: +91-484-2450330 Mob: +91-8714504684

Web: <http://www.scmsgroup.org/sset/computer-science-engineering/dr-varun-g-menon>



SCMS

School of Engineering & Technology

On Sat, Jun 23, 2018 at 6:42 PM, International Affairs, DIU

<int@daffodilvarsity.edu.bd> wrote:

Dear Dr. Varun G Menon,

Greetings from DIU!

Thanks for your email and showing interest in the academic partnership. Yes, we can Ccollaborate in the areas of student exchange programs, faculty exchange programs, summer school research collaborations, joint seminars and conferences.

I have attached here the sample agreement copy of DIU, Could you please check and fill it with your information. Besides, I have attached here the fact sheet of DIU where you can check our common details and department.

Your CSE, ECE and EEE Department can be a good prospect between both universities. Let us know your observation

Looking forward to hearing from you soon.

- With best regards

Syed Raihan-UI-Islam

Senior Administrative Officer, International Affairs
Daffodil International University

102/1, Shukrabad, Dhanmondi, Dhaka-1207, Bangladesh.

Tel: +88 02 9138234 (Ext: 237) | Mob: +88-01811458865

WhatsApp/Viber/Wechat: +88-01920012744

Respected Mr. Salahuddin Morsalin

Thank you for your time and consideration. Let me introduce as Dr. Varun G Menon, in charge of International Collaborations at SCMS Group of Educational Institutions, India.

We are interested in having academic collaboration with Daffodil International University. Collaboration could be in the areas of student exchange programs, faculty exchange programs, research collaborations, joint seminars and conferences.

We have a dedicate team of faculty and students working in areas like Robotics, Brain Signal Analysis, Computational fluid dynamics . Water Quality Monitoring and Assessment, Limnology, Water Audit, Environmental Remote Sensing , Android Malware Analysis . Research collaborations in these areas is another possibility.

We have academic collaborations with leading international universities like Vrije University-Brussels, Furtwangen University-Germany, University of Applied Sciences Ravensburg Weingarten-Germany, Shimane University-Japan and more.

Please let me know if we could discuss and take forward this initiative.

For your information we are the No 1 ranked private educational institutions in the state. You can find more information about our institutions in www.scmsgroup.org and about our Engineering Institute in www.scmsgroup.org/sset/

Have a Great Day.

Thanks and Regards,

Dr. Varun G Menon

Associate Professor-Computer Science Engineering
Exe. Officer-Corporate Relations & International
Collaborations

SCMS School of Engineering and Technology

Kerala, India-683582

Office: +91-484-2450330 Mob: +91-8714504684

Web: <http://www.scmsgroup.org/sset/computer-science-engineering/dr-varun-g-menon>



SCMS

School of Engineering & Technology

--
Thanks and Regards,

Dr. Varun G Menon

Associate Professor-Computer Science Engineering
Exe. Officer-Corporate Relations & International Collaborations
SCMS School of Engineering and Technology
Kerala, India-683582
Office: +91-484-2450330 Mob: +91-8714504684
Web: <http://www.scmsgroup.org/sset/computer-science-engineering/dr-varun-g-menon>



SCMS
School of Engineering & Technology

--
Thanks and Regards,

Dr. Varun G Menon

Associate Professor-Computer Science Engineering
Exe. Officer-Corporate Relations & International Collaborations
SCMS School of Engineering and Technology
Kerala, India-683582
Office: +91-484-2450330 Mob: +91-8714504684
Web: <http://www.scmsgroup.org/sset/computer-science-engineering/dr-varun-g-menon>



SCMS
School of Engineering & Technology

--
Thanks and Regards,

Dr. Varun G Menon

Associate Professor-Computer Science Engineering
Exe. Officer-Corporate Relations & International Collaborations
SCMS School of Engineering and Technology
Kerala, India-683582
Office: +91-484-2450330 Mob: +91-8714504684
Web: <http://www.scmsgroup.org/sset/computer-science-engineering/dr-varun-g-menon>



SCMS
School of Engineering & Technology

International Affairs, DIU <int@daffodilvarsity.edu.bd>

Sun, Aug 19, 2018 at 3:13 PM

To: "Dr. Varun G Menon" <varunmenon@scmsgroup.org>

Cc: Emran Hossain <emran@daffodilvarsity.edu.bd>, "International, DIU" <international@daffodilvarsity.edu.bd>, "Office of the International Affairs, DIU" <mobility@daffodilvarsity.edu.bd>, Scholarship News <scholarship@daffodilvarsity.edu.bd>, Pramod <pramod@scmsgroup.org>, Anupama COK <anupama@scmsgroup.org>, Kazi Mesbah Ur Rahman <oia@daffodilvarsity.edu.bd>

Dear Dr. Varun,

Greetings!

Hope you are doing well. We thank you and honorable Vice Chairman for visiting us and sign the agreement. Let us work and plan together to activate the partnership soon.

So far I remember you have some program plans that you were working to send me. Once it's ready please do send us, At the same time, we invite your faculty member to come and teach for short term period as exchange faculty. let us know the possibility

Here I attached some news coverage that published in different national daily newspapers (Both Bangla and English) about the agreement signing between DIU and SCMS group.

Have a great day!

- *With best regards*

Syed Raihan-UI-Islam

Senior Administrative Officer, International Affairs

Daffodil International University

102/1, Shukrabad, Dhanmondi, Dhaka-1207, Bangladesh.

Tel: **+88 02 9138234 (Ext: 237)** | Mob: **+88-01811458865**

WhatsApp/Viber/Wechat: **+88-01920012744**

On Fri, Jul 13, 2018 at 1:51 PM, International Affairs, DIU <int@daffodilvarsity.edu.bd> wrote:

Dear Dr. Varun

Yes we will arrange pick and drop for you and your Vice Chairman

- *With best regards*

Syed Raihan-UI-Islam

Senior Administrative Officer, International Affairs

Daffodil Internsity

102/1, Shukrabad, Dhanmondi, Dhaka-1207, Bangladesh.

Tel: **+88 02 9138234 (Ext: 237)** | Mob: **+88-01811458865**

WhatsApp/Viber/Wechat: **+88-01920012744**

On Thu, Jul 12, 2018 at 9:58 PM, Dr. Varun G Menon <varunmenon@scmsgroup.org> wrote:

Dear Mr. Syed Raihan-UI-Islam,

Thank you for the collaboration with SCMS.

Kindly see below the details of hotel reserved by us

Hotel Name: Best Western B/W La Vinci Hotel

Address: 54, Kawran Bazar, Dhaka, Bangladesh 1215

Please let me know if you would be arranging a pick up from the hotel to the DIU campus. We could start at 1.30 pm from the hotel to the DIU campus for the visit and signing of the MoU.

Thanks and Regards,

Dr. Varun G Menon

Associate Professor & Head of International Relations

SCMS Group of Educational Institutions

Cochin, Kerala, India-683106

Office: +91-484-2450330 Mob: +91-8714504684

Web: <http://www.scmsgroup.org>



SCMS

GROUP OF EDUCATIONAL INSTITUTIONS

On Mon, Jul 9, 2018 at 10:58 AM, International Affairs, DIU <int@daffodilvarsity.edu.bd> wrote:

Dear Dr. Varun,

Here is the address that i already gave you in whatsapp:

[Daffodil International University](#)
102/1, Shukrabad, Dhanmondi, Dhaka-1207
Bangladesh

some hotels nearby our campus:

<http://www.ambalainn.com>

<https://www.panpacific.com/en/hotels-and-resorts/pp-dhaka.html>

- With best regards

Syed Raihan-UI-Islam

Senior Administrative Officer, International Affairs

Daffodil International University

102/1, Shukrabad, Dhanmondi, Dhaka-1207, Bangladesh.

Tel: **+88 02 9138234 (Ext: 237)** | Mob: **+88-01811458865**

WhatsApp/Viber/Wechat: **+88-01920012744**

On Thu, Jul 5, 2018 at 5:25 PM, Dr. Varun G Menon <varunmenon@scmsgroup.org> wrote:

Dear Mr. Syed Raihan-UI-Islam,

Thank you for the collaboration with SCMS. Please let us know the campus address of DIU where the visit and MoU signing ceremony is planned so that we could arrange the stay in a hotel near the campus. We could see multiple campuses of DIU in the website. It would also be great if you could give the names of few good hotels near your campus.

Thanks and Regards,

Dr. Varun G Menon

Associate Professor, Computer Science Engineering

Exe. Officer, Corporate Relations & International Collaborations

SCMS School of Engineering and Technology

Kerala, India-683582

Office: +91-484-2450330 Mob: +91-8714504684

Web: <http://www.scmsgroup.org/sset/computer-science-engineering/dr-varun-g-memon>



SCMS
School of Engineering & Technology

On Tue, Jul 3, 2018 at 5:04 PM, International Affairs, DIU <int@daffodilvarsity.edu.bd> wrote:
Dear Dr. Varun

Yes Confirm so far. Thank You

- With best regards

Syed Raihan-UI-Islam

Senior Administrative Officer, International Affairs
Daffodil International University

102/1, Shukrabad, Dhanmondi, Dhaka-1207, Bangladesh.

Tel: **+88 02 9138234 (Ext: 237)** | Mob: **+88-01811458865**

WhatsApp/Viber/Wechat: **+88-01920012744**

On Tue, Jul 3, 2018 at 3:57 AM, Dr. Varun G Menon <varunmenon@scmsgroup.org> wrote:
Dear Mr. Syed Raihan-UI-Islam

Thank you for the valuable time. Please confirm the schedule as discussed and agreed earlier. No need to change the schedule. Our flight is scheduled only in the night.

- MoU Signing Ceremony and discussion session on **25th July 2018** from **3PM to 5PM**
- Visit to DIU Permanent Campus and Lunch on the on that day **9AM to 2PM**

Thanks and Regards,

Dr. Varun G Menon

Associate Professor, Computer Science Engineering

Exe. Officer, Corporate Relations & International Collaborations

SCMS School of Engineering and Technology

Kerala, India-683582

Office: +91-484-2450330 Mob: +91-8714504684

Web: <http://www.scmsgroup.org/sset/computer-science-engineering/dr-varun-g-menon>



SCMS
School of Engineering & Technology

On Sun, Jul 1, 2018 at 12:09 PM, Dr. Varun G Menon <varunmenon@scmsgroup.org> wrote:

Dear Mr. Syed Raihan-UI-Islam,

Please let me know if you can arrange the MoU signing ceremony and discussion on collaboration at DIU on **25th July morning** as we have flight back to India in the evening.

Thank you,

Dr. Varun G Menon

Associate Professor-Computer Science Engineering

Exe. Officer-Corporate Relations & International Collaborations

SCMS School of Engineering and Technology

Kerala, India-683582

Office: +91-484-2450330 Mob: +91-8714504684

Web: <http://www.scmsgroup.org/sset/computer-science-engineering/dr-varun-g-menon>



SCMS
School of Engineering & Technology

On Thu, Jun 28, 2018 at 1:32 PM, Dr. Varun G Menon <varunmenon@scmsgroup.org> wrote:

Dear Mr. Syed Raihan-UI-Islam,

Thank you for the invitation letter. Looking forward to the meeting. Will update our schedule once we confirm the flight tickets.

Thanks and Regards,

Dr. Varun G Menon

Associate Professor-Computer Science Engineering
Exe. Officer-Corporate Relations & International Collaborations
SCMS School of Engineering and Technology
Kerala, India-683582
Office: +91-484-2450330 Mob: +91-8714504684
Web: <http://www.scmsgroup.org/sset/computer-science-engineering/dr-varun-g-menon>



SCMS
School of Engineering & Technology

On Thu, Jun 28, 2018 at 1:09 PM, International Affairs, DIU <int@daffodilvarsity.edu.bd> wrote:

Dear Dr. Varun

Please find the attached letter of Invitation for both of you to visit us for the purpose of the meeting and signing the agreement.

- *With best regards*

Syed Raihan-UI-Islam

Senior Administrative Officer, International Affairs
Daffodil International University
102/1, Shukrabad, Dhanmondi, Dhaka-1207, Bangladesh.
Tel: **+88 02 9138234 (Ext: 237)** | Mob: **+88-01811458865**
WhatsApp/Viber/Wechat: **+88-01920012744**

On Thu, Jun 28, 2018 at 8:20 AM, Dr. Varun G Menon <varunmenon@scmsgroup.org> wrote:

Dear Mr. Syed Raihan-UI-Islam,

Please see below the details of members visiting DIU on 25th July 2018. Please send us the **invitation letter for the Visa** based on this information.

Names

Prof. **PRAMOD PRATHAPACHANDRAN THEVANNOOR**, Vice Chairman, SCMS Group of Educational Institutions.

Dr. **VARUN GIRIJAN MENON**, Associate Professor and International Relations in-charge, SCMS Group of Educational Institutions.

Address

SCMS Group of Educational Institutions
SCMS Campus, Prathap Nagar
Muttom, Aluva
Cochin – 683 106, Kerala, INDIA

Let me know any further information required.

Thanks and Regards,

Dr. Varun G Menon

Associate Professor-Computer Science Engineering
Exe. Officer-Corporate Relations & International Collaborations
SCMS School of Engineering and Technology
Kerala, India-683582
Office: +91-484-2450330 Mob: +91-8714504684
Web: <http://www.scmsgroup.org/sset/computer-science-engineering/dr-varun-g-menon>



SCMS
School of Engineering & Technology

On Wed, Jun 27, 2018 at 11:48 AM, International Affairs, DIU <int@daffodilvarsity.edu.bd> wrote:
Dear Dr. Varun

Thanks. I am looking forward.

- With best regards

Syed Raihan-UI-Islam

Senior Administrative Officer, International Affairs

Daffodil International University

102/1, Shukrabad, Dhanmondi, Dhaka-1207, Bangladesh.

Tel: **+88 02 9138234 (Ext: 237)** | Mob: **+88-01811458865**

WhatsApp/Viber/Wechat: **+88-01920012744**

On Wed, Jun 27, 2018 at 12:15 PM, Dr. Varun G Menon <varunmenon@scmsgroup.org> wrote:

Dear Mr. Syed Raihan-UI-Islam,

Thank you for the information. We will have the visit on 25th July. We will send the details of the members visiting the DIU campus at the earliest.

Regards

Varun

On Wednesday, June 27, 2018, International Affairs, DIU <int@daffodilvarsity.edu.bd> wrote:

Dear Dr. Varun,

I have discussed with the Office of the Vice Chancellor

We can arrange the MoU Signing Ceremony and discussion session on **25 July 2018** from **3PM to 5PM**

We can also arrange to visit our Permanent Campus and Lunch on the on that day 9AM to 2PM too.

Let us know if the time and date is convenient for your visit

Looking forward to hearing from you.

- With best regards

Syed Raihan-UI-Islam

Senior Administrative Officer, International Affairs

Daffodil International University

102/1, Shukrabad, Dhanmondi, Dhaka-1207, Bangladesh.

Tel: **+88 02 9138234 (Ext: 237)** | Mob: **+88-01811458865**

WhatsApp/Viber/Wechat: **+88-01920012744**

On Wed, Jun 27, 2018 at 11:18 AM, Dr. Varun G Menon <varunmenon@scmsgroup.org> wrote:

Dear Mr. Syed Raihan-UI-Islam,

Can we have the visit between July 24 and 27. Our Vice Chairman is traveling on other dates in July.

Please let me know.

Varun

On Wednesday, June 27, 2018, International Affairs, DIU <int@daffodilvarsity.edu.bd> wrote:

Dear Dr. Varun

Can we shift it to the next week I mean in between 15 to 20 July?

- With best regards

Syed Raihan-UI-Islam

Senior Administrative Officer, International Affairs

Daffodil International University

102/1, Shukrabad, Dhanmondi, Dhaka-1207, Bangladesh.

Tel: **+88 02 9138234 (Ext: 237)** | Mob: **+88-01811458865**

WhatsApp/Viber/Wechat: **+88-01920012744**

On Wed, Jun 27, 2018 at 10:55 AM, Dr. Varun G Menon <varunmenon@scmsgroup.org> wrote:

Dear Mr. Syed Raihan-UI-Islam,

Thank you for the message. We would like to visit DIU between 10th and 14th July. Please let us know if the date is convenient at your end. Also it would be great if you could send us an Invitation letter which could be produced for the Visa.

Let me know any further details required.

Varun

On Tuesday, June 26, 2018, International Affairs, DIU <int@daffodilvarsity.edu.bd> wrote:

Dear Dr. Varun

That is a good idea. Let us know your possible dates to visit us and sign the agreement between both of the universities.

- With best regards

Syed Raihan-UI-Islam

Senior Administrative Officer, International Affairs

Daffodil International University

102/1, Shukrabad, Dhanmondi, Dhaka-1207, Bangladesh.

Tel: **+88 02 9138234 (Ext: 237)** | Mob: **+88-01811458865**

WhatsApp/Viber/Wechat: **+88-01920012744**

On Tue, Jun 26, 2018 at 10:38 PM, Dr. Varun G Menon <varunmenon@scmsgroup.org> wrote:

Dear Mr. Syed Raihan-UI-Islam,

Thank you for the collaboration with SCMS. We would like to visit the DIU campus on a favorable date and would like to sign the MoU with the Vice Chancellor at DIU.

We would be more than happy to host the DIU team with Vice Chancellor in our campus in future. Please let me know your thoughts.

Thanks and Regards,

Dr. Varun G Menon

Associate Professor-Computer Science Engineering

Exe. Officer-Corporate Relations & International Collaborations

SCMS School of Engineering and Technology

Kerala, India-683582

Office: +91-484-2450330 Mob: +91-8714504684

Web: <http://www.scmsgroup.org/sset/computer-science-engineering/dr-varun-g-menon>



SCMS

School of Engineering & Technology

On Tue, Jun 26, 2018 at 6:54 PM, International Affairs, DIU <int@daffodilvarsity.edu.bd> wrote:

Dear Dr. Varun

Thank you very much for the agreement final copy. It's fine

May I request you to sign the agreement and send the copies to me either scan copy in my email or 2 original copies in my address given in my email signature

- With best regards

Syed Raihan-UI-Islam

Senior Administrative Officer, International Affairs
Daffodil International University

102/1, Shukrabad, Dhanmondi, Dhaka-1207, Bangladesh.

Tel: **+88 02 9138234 (Ext: 237)** | Mob: **+88-01811458865**

WhatsApp/Viber/Wechat: **+88-01920012744**

On Tue, Jun 26, 2018 at 7:01 PM, Dr. Varun G Menon

<varunmenon@scmsgroup.org> wrote:

Dear Mr. Syed Raihan-UI-Islam,

Thank you for the collaboration with SCMS. Please see the attached MoU draft approved by our Vice Chairman. Please let me know the remaining procedures including the signing of the MoU.

Thanks and Regards,

Dr. Varun G Menon

Associate Professor-Computer Science Engineering

Exe. Officer-Corporate Relations & International Collaborations

SCMS School of Engineering and Technology

Kerala, India-683582

Office: +91-484-2450330 Mob: +91-8714504684

Web: <http://www.scmsgroup.org/sset/computer-science-engineering/dr-varun-g-menon>



SCMS

School of Engineering & Technology

On Mon, Jun 25, 2018 at 3:55 PM, International Affairs, DIU

<int@daffodilvarsity.edu.bd> wrote:

Dear Dr. Varun

Thank you so much for your email and letting us know the update.

- With best regards

Syed Raihan-UI-Islam

Senior Administrative Officer, International Affairs
Daffodil International University

102/1, Shukrabad, Dhanmondi, Dhaka-1207, Bangladesh.

Tel: **+88 02 9138234 (Ext: 237)** | Mob: **+88-01811458865**

WhatsApp/Viber/Wechat: **+88-01920012744**

On Mon, Jun 25, 2018 at 4:14 PM, Dr. Varun G Menon

<varunmenon@scmsgroup.org> wrote:

Dear Mr. Syed Raihan-UI-Islam,

Thank you for the collaboration with SCMS. I have presented the MoU with the Vice Chairman for approval. Once the approval is obtained, I will send back the approved soft copy of the MoU.

I have discussed about the Short Term Internships for students from DIU at the Centre for Robotics, SCMS with the Director, Robotics Lab. He has promised to send me The Best Plan for DIU students within two days. I will send you the same at the earliest.

Thanks and Regards,

Dr. Varun G Menon

Associate Professor-Computer Science Engineering

Exe. Officer-Corporate Relations & International Collaborations

SCMS School of Engineering and Technology

Kerala, India-683582

Office: +91-484-2450330 Mob: +91-8714504684

Web: <http://www.scmsgroup.org/sset/computer-science-engineering/dr-varun-g-menon>



SCMS

School of Engineering & Technology

On Sun, Jun 24, 2018 at 12:56 AM, Dr. Varun G Menon

<varunmenon@scmsgroup.org> wrote:

Dear Mr. Syed Raihan-UI-Islam,

Thank you for the email. Will inform the Professor's in charge of the Cyber Security and Robotics research centers about the program plan. Will sent you the documents soon.

Have a Great Day.

Thanks and Regards,

Dr. Varun G Menon

Associate Professor-Computer Science Engineering

Exe. Officer-Corporate Relations & International Collaborations

SCMS School of Engineering and Technology

Kerala, India-683582

Office: +91-484-2450330 Mob: +91-8714504684

Web: <http://www.scmsgroup.org/sset/computer-science-engineering/dr-varun-g-menon>



SCMS

School of Engineering & Technology

On Sun, Jun 24, 2018 at 12:17 AM, International Affairs, DIU

<int@daffodilvarsity.edu.bd> wrote:

Dear Dr, Varun

Thank you very much for your quick response.

It would be great if you can share any proposal or program plan with all details, course plan, costing etc of the Summer internships based on Cyber Security and Robotics so that we could check and show t our students for interest.

Hope to receive the agreement and the program proposals soon. Have a great day !

- With best regards

Syed Raihan-UI-Islam

Senior Administrative Officer, International Affairs

Daffodil International University

102/1, Shukrabad, Dhanmondi, Dhaka-1207, Bangladesh.

Tel: **+88 02 9138234 (Ext: 237)** | Mob: **+88-01811458865**
WhatsApp/Viber/Wechat: **+88-01920012744**

On Sun, Jun 24, 2018 at 12:35 AM, Dr. Varun G Menon
<varunmenon@scmsgroup.org> wrote:

Dear Mr. Syed Raihan-UI-Islam,

Thank you for the information about Daffodil International University. Will complete the agreement copy and send you at the earliest.

We have 5 active research groups in our Engineering College that include Centre for Robotics, Centre for Cyber Security, Hydrodynamics and Computational Fluid Dynamics, Antennas and Radiation, Centre for Sustainable Water Technology and Management. Students from your University can do summer internships and short term projects with these project groups.

Besides we also have one of the leading Management Institute in India and also Biotechnology Research Centre.

Thank you for the collaboration. Will send you the document soon.

Regards,

Dr. Varun G Menon

Associate Professor-Computer Science Engineering
Exe. Officer-Corporate Relations & International
Collaborations

SCMS School of Engineering and Technology
Kerala, India-683582

Office: +91-484-2450330 Mob: +91-8714504684

Web: <http://www.scmsgroup.org/sset/computer-science-engineering/dr-varun-g-memon>



SCMS

School of Engineering & Technology

On Sat, Jun 23, 2018 at 6:42 PM, International Affairs, DIU
<int@daffodilvarsity.edu.bd> wrote:

Dear Dr. Varun G Menon,

Greetings from DIU!

Thanks for your email and showing interest in the academic partnership. Yes, we can collaborate in the areas of student exchange programs, faculty exchange programs, summer school research collaborations, joint seminars and conferences.

I have attached here the sample agreement copy of DIU, Could you please check and fill it with your information. Besides, I have attached here the fact sheet of DIU where you can check our common details and department.

Your CSE, ECE and EEE Department can be a good prospect between both universities. Let us know your observation

Looking forward to hearing from you soon.

- With best regards

Syed Raihan-UI-Islam

Senior Administrative Officer, International Affairs

Daffodil International University

102/1, Shukrabad, Dhanmondi, Dhaka-1207, Bangladesh.

Tel: **+88 02 9138234 (Ext: 237)** | Mob: **+88-01811458865**
WhatsApp/Viber/Wechat: **+88-01920012744**

Respected Mr. Salahuddin Morsalin

Thank you for your time and consideration. Let me introduce as Dr. Varun G Menon, in charge of International Collaborations at SCMS Group of Educational Institutions, India.

We are interested in having academic collaboration with Daffodil International University. Collaboration could be in the areas of student exchange programs, faculty exchange programs, research collaborations, joint seminars and conferences.

We have a dedicate team of faculty and students working in areas like Robotics, Brain Signal Analysis, Computational fluid dynamics. Water Quality Monitoring and Assessment, Limnology, Water Audit, Environmental Remote Sensing , Android Malware Analysis. Research collaborations in these areas is another possibility.

We have academic collaborations with leading international universities like Vrije University-Brussels, Furtwangen University-Germany, University of Applied Sciences Ravensburg Weingarten- Germany, Shimane University-Japan and more.

Please let me know if we could discuss and take forward this initiative.

For your information we are the No 1 ranked private educational institutions in the state. You can find more information about our institutions in www.scmsgroup.org and about out Engineering Institute in www.scmsgroup.org/sset/

Have a Great Day.

Thanks and Regards,

Dr. Varun G Menon

Associate Professor-Computer Science Engineering
Exe. Officer-Corporate Relations & International
Collaborations

SCMS School of Engineering and Technology
Kerala, India-683582

Office: +91-484-2450330 Mob: +91-8714504684

Web: <http://www.scmsgroup.org/sset/computer-science-engineering/dr-varun-g-menon>



SCMS

School of Engineering & Technology

--
Thanks and Regards,

Dr. Varun G Menon

Associate Professor-Computer Science Engineering
Exe. Officer-Corporate Relations & International Collaborations
SCMS School of Engineering and Technology
Kerala, India-683582
Office: +91-484-2450330 Mob: +91-8714504684
Web: <http://www.scmsgroup.org/sset/computer-science-engineering/dr-varun-g-menon>



--
Thanks and Regards,

Dr. Varun G Menon

Associate Professor-Computer Science Engineering
Exe. Officer-Corporate Relations & International Collaborations
SCMS School of Engineering and Technology
Kerala, India-683582
Office: +91-484-2450330 Mob: +91-8714504684
Web: <http://www.scmsgroup.org/sset/computer-science-engineering/dr-varun-g-menon>



--
Thanks and Regards,

Dr. Varun G Menon

Associate Professor-Computer Science Engineering
Exe. Officer-Corporate Relations & International Collaborations
SCMS School of Engineering and Technology
Kerala, India-683582
Office: +91-484-2450330 Mob: +91-8714504684
Web: <http://www.scmsgroup.org/sset/computer-science-engineering/dr-varun-g-menon>



8 attachments



01.jpg
554K

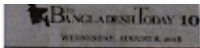

02.jpg
1013K

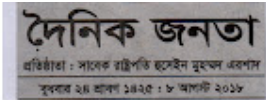

03.jpg
365K

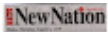

04.jpg
1416K



05.jpg
535K

06.jpg
556K



07.jpg
603K

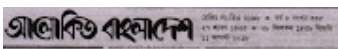

08.jpg
554K

Dr. Varun G Menon <varunmenon@scmsgroup.org> Mon, Aug 20, 2018 at 12:14 PM
 To: "International Affairs, DIU" <int@daffodilvarsity.edu.bd>
 Cc: Emran Hossain <emran@daffodilvarsity.edu.bd>, "International, DIU" <international@daffodilvarsity.edu.bd>, "Office of the International Affairs, DIU" <mobility@daffodilvarsity.edu.bd>, Scholarship News <scholarship@daffodilvarsity.edu.bd>, Pramod <pramod@scmsgroup.org>, Kazi Mesbah Ur Rahman <oia@daffodilvarsity.edu.bd>, Indu Nair <indunair@scmsgroup.org>, "Dr. Praveensal C.J." <praveensal@scmsgroup.org>

Dear Mr. Syed Raihan-UI-Islam,
 Hope you are doing great. Thank you for the information on media coverage and photos of the MoU signing between SCMS and Daffodil International University.
 We are having holidays till August 29th. Will send you the program details soon.
 I will discuss the possibility of Visiting faculty from SCMS at DIU and will let you know.

Thanks and Regards,

Dr. Varun G Menon
 Associate Professor & Head of International Relations
 SCMS Group of Educational Institutions
 Cochin, Kerala, India-683106
 Office: +91-484-2450330 Mob: +91-8714504684
 Web: <http://www.scmsgroup.org>



On Sun, Aug 19, 2018 at 3:13 PM, International Affairs, DIU <int@daffodilvarsity.edu.bd> wrote:
 Dear Dr. Varun,

Greetings!

Hope you are doing well. We thank you and honorable Vice Chairman for visiting us and sign the agreement. Let us work and plan together to activate the partnership soon.

So far I remember you have some program plans that you were working to send me. Once it's ready please do send us, At the same time, we invite your faculty member to come and teach for short term period as exchange faculty. let us know the possibility

Here I attached some news coverage that published in different national daily newspapers (Both Bangla and English) about the agreement signing between DIU and SCMS group.

Have a great day!

- With best regards

Syed Raihan-UI-Islam

Senior Administrative Officer, International Affairs

Daffodil International University

102/1, Shukrabad, Dhanmondi, Dhaka-1207, Bangladesh.

Tel: **+88 02 9138234 (Ext: 237)** | Mob: **+88-01811458865**

WhatsApp/Viber/Wechat: **+88-01920012744**

On Fri, Jul 13, 2018 at 1:51 PM, International Affairs, DIU <int@daffodilvarsity.edu.bd> wrote:

Dear Dr. Varun

Yes we will arrange pick and drop for you and your Vice Chairman

- With best regards

Syed Raihan-UI-Islam

Senior Administrative Officer, International Affairs

Daffodil International University

102/1, Shukrabad, Dhanmondi, Dhaka-1207, Bangladesh.

Tel: **+88 02 9138234 (Ext: 237)** | Mob: **+88-01811458865**

WhatsApp/Viber/Wechat: **+88-01920012744**

On Thu, Jul 12, 2018 at 9:58 PM, Dr. Varun G Menon <varunmenon@scmsgroup.org> wrote:

Dear Mr. Syed Raihan-UI-Islam,

Thank you for the collaboration with SCMS.

Kindly see below the details of hotel reserved by us

Hotel Name: Best Western B/W La Vinci Hotel

Address: 54, Kawran Bazar, Dhaka, Bangladesh 1215

Please let me know if you would be arranging a pick up from the hotel to the DIU campus. We could start at 1.30 pm from the hotel to the DIU campus for the visit and signing of the MoU.

Thanks and Regards,

Dr. Varun G Menon

Associate Professor & Head of International Relations

SCMS Group of Educational Institutions

Cochin, Kerala, India-683106

Office: +91-484-2450330 Mob: +91-8714504684

Web: <http://www.scmsgroup.org>



SCMS

GROUP OF EDUCATIONAL INSTITUTIONS

On Mon, Jul 9, 2018 at 10:58 AM, International Affairs, DIU <int@daffodilvarsity.edu.bd> wrote:

Dear Dr. Varun,

Here is the address that i already gave you in whatsapp:

Daffodil International University

102/1, Shukrabad, Dhanmondi, Dhaka-1207

Bangladesh

some hotels nearby our campus:

<http://www.ambalainn.com>

<https://www.panpacific.com/en/hotels-and-resorts/pp-dhaka.html>

- With best regards

Syed Raihan-UI-Islam

Senior Administrative Officer, International Affairs

Daffodil International University

102/1, Shukrabad, Dhanmondi, Dhaka-1207, Bangladesh.

Tel: **+88 02 9138234 (Ext: 237)** | Mob: **+88-01811458865**

WhatsApp/Viber/Wechat: **+88-01920012744**

On Thu, Jul 5, 2018 at 5:25 PM, Dr. Varun G Menon <varunmenon@scmsgroup.org> wrote:

Dear Mr. Syed Raihan-UI-Islam,

Thank you for the collaboration with SCMS. Please let us know the campus address of DIU where the visit and MoU signing ceremony is planned so that we could arrange the stay in a hotel near the campus. We could see multiple campuses of DIU in the website. It would also be great if you could give the names of few good hotels near your campus.

Thanks and Regards,

Dr. Varun G Menon

Associate Professor, Computer Science Engineering

Exe. Officer, Corporate Relations & International Collaborations

SCMS School of Engineering and Technology

Kerala, India-683582

Office: +91-484-2450330 Mob: +91-8714504684

Web: <http://www.scmsgroup.org/sset/computer-science-engineering/dr-varun-g-menon>



SCMS

School of Engineering & Technology

On Tue, Jul 3, 2018 at 5:04 PM, International Affairs, DIU <int@daffodilvarsity.edu.bd> wrote:

Dear Dr. Varun

Yes Confirm so far. Thank You

- With best regards

Syed Raihan-UI-Islam

Senior Administrative Officer, International Affairs

Daffodil International University

102/1, Shukrabad, Dhanmondi, Dhaka-1207, Bangladesh.

Tel: **+88 02 9138234 (Ext: 237)** | Mob: **+88-01811458865**

WhatsApp/Viber/Wechat: **+88-01920012744**

On Tue, Jul 3, 2018 at 3:57 AM, Dr. Varun G Menon <varunmenon@scmsgroup.org> wrote:

Dear Mr. Syed Raihan-UI-Islam

Thank you for the valuable time. Please confirm the schedule as discussed and agreed earlier. No need to change the schedule. Our flight is scheduled only in the night.

- MoU Signing Ceremony and discussion session on **25th July 2018 from 3PM to 5PM**
- Visit to DIU Permanent Campus and Lunch on the on that day **9AM to 2PM**

Thanks and Regards,

Dr. Varun G Menon

Associate Professor, Computer Science Engineering

Exe. Officer, Corporate Relations & International Collaborations

SCMS School of Engineering and Technology

Kerala, India-683582

Office: +91-484-2450330 Mob: +91-8714504684

Web: <http://www.scmsgroup.org/sset/computer-science-engineering/dr-varun-g-menon>



On Sun, Jul 1, 2018 at 12:09 PM, Dr. Varun G Menon <varunmenon@scmsgroup.org> wrote:

Dear Mr. Syed Raihan-UI-Islam,

Please let me know if you can arrange the MoU signing ceremony and discussion on collaboration at DIU on **25th July morning** as we have flight back to India in the evening.

Thank you,

Dr. Varun G Menon

Associate Professor-Computer Science Engineering
Exe. Officer-Corporate Relations & International Collaborations
SCMS School of Engineering and Technology
Kerala, India-683582

Office: +91-484-2450330 Mob: +91-8714504684

Web: <http://www.scmsgroup.org/sset/computer-science-engineering/dr-varun-g-menon>



On Thu, Jun 28, 2018 at 1:32 PM, Dr. Varun G Menon <varunmenon@scmsgroup.org> wrote:

Dear Mr. Syed Raihan-UI-Islam,

Thank you for the invitation letter. Looking forward to the meeting. Will update our schedule once we confirm the flight tickets.

Thanks and Regards,

Dr. Varun G Menon

Associate Professor-Computer Science Engineering
Exe. Officer-Corporate Relations & International Collaborations
SCMS School of Engineering and Technology
Kerala, India-683582

Office: +91-484-2450330 Mob: +91-8714504684

Web: <http://www.scmsgroup.org/sset/computer-science-engineering/dr-varun-g-menon>



On Thu, Jun 28, 2018 at 1:09 PM, International Affairs, DIU <int@daffodilvarsity.edu.bd> wrote:

Dear Dr. Varun

Please find the attached letter of Invitation for both of you to visit us for the purpose of the meeting and signing the agreement.

- *With best regards*

Syed Raihan-UI-Islam

Senior Administrative Officer, International Affairs

Daffodil International University

102/1, Shukrabad, Dhanmondi, Dhaka-1207, Bangladesh.

Tel: **+88 02 9138234 (Ext: 237)** | Mob: **+88-01811458865**
WhatsApp/Viber/Wechat: **+88-01920012744**

On Thu, Jun 28, 2018 at 8:20 AM, Dr. Varun G Menon <varunmenon@scmsgroup.org> wrote:

Dear Mr. Syed Raihan-UI-Islam,

Please see below the details of members visiting DIU on 25th July 2018. Please send us the **invitation letter for the Visa** based on this information.

Names

Prof. **PRAMOD PRATHAPACHANDRAN THEVANNOOR**, Vice Chairman, SCMS Group of Educational Institutions.

Dr. **VARUN GIRIJAN MENON**, Associate Professor and International Relations in-charge, SCMS Group of Educational Institutions.

Address

SCMS Group of Educational Institutions
SCMS Campus, Prathap Nagar
Muttom, Aluva
Cochin – 683 106, Kerala, INDIA

Let me know any further information required.

Thanks and Regards,

Dr. Varun G Menon

Associate Professor-Computer Science Engineering
Exe. Officer-Corporate Relations & International Collaborations
SCMS School of Engineering and Technology
Kerala, India-683582
Office: +91-484-2450330 Mob: +91-8714504684
Web: <http://www.scmsgroup.org/sset/computer-science-engineering/dr-varun-g-menon>



SCMS
School of Engineering & Technology

On Wed, Jun 27, 2018 at 11:48 AM, International Affairs, DIU <int@daffodilvarsity.edu.bd> wrote:

Dear Dr. Varun

Thanks. I am looking forward.

- *With best regards*

Syed Raihan-UI-Islam

Senior Administrative Officer, International Affairs
Daffodil International University

102/1, Shukrabad, Dhanmondi, Dhaka-1207, Bangladesh.

Tel: **+88 02 9138234 (Ext: 237)** | Mob: **+88-01811458865**

WhatsApp/Viber/Wechat: **+88-01920012744**

On Wed, Jun 27, 2018 at 12:15 PM, Dr. Varun G Menon <varunmenon@scmsgroup.org> wrote:

Dear Mr. Syed Raihan-UI-Islam,

Thank you for the information. We will have the visit on 25th July. We will send the details of the members visiting the DIU campus at the earliest.

Regards

Varun

On Wednesday, June 27, 2018, International Affairs, DIU <int@daffodilvarsity.edu.bd> wrote:

Dear Dr. Varun,

I have discussed with the Office of the Vice Chancellor

We can arrange the MoU Signing Ceremony and discussion session on **25 July 2018** from **3PM to 5PM**

We can also arrange to visit our Permanent Campus and Lunch on the on that day 9AM to 2PM too.

Let us know if the time and date is convenient for your visit

Looking forward to hearing from you.

- *With best regards*

Syed Raihan-UI-Islam

Senior Administrative Officer, International Affairs

Daffodil International University

102/1, Shukrabad, Dhanmondi, Dhaka-1207, Bangladesh.

Tel: **+88 02 9138234 (Ext: 237)** | Mob: **+88-01811458865**

WhatsApp/Viber/Wechat: **+88-01920012744**

On Wed, Jun 27, 2018 at 11:18 AM, Dr. Varun G Menon <varunmenon@scmsgroup.org> wrote:

Dear Mr. Syed Raihan-UI-Islam,

Can we have the visit between July 24 and 27. Our Vice Chairman is traveling on other dates in July.

Please let me know.

Varun

On Wednesday, June 27, 2018, International Affairs, DIU <int@daffodilvarsity.edu.bd> wrote:

Dear Dr. Varun

Can we shift it to the next week I mean in between 15 to 20 July?

- *With best regards*

Syed Raihan-UI-Islam

Senior Administrative Officer, International Affairs

Daffodil International University

102/1, Shukrabad, Dhanmondi, Dhaka-1207, Bangladesh.

Tel: **+88 02 9138234 (Ext: 237)** | Mob: **+88-01811458865**

WhatsApp/Viber/Wechat: **+88-01920012744**

On Wed, Jun 27, 2018 at 10:55 AM, Dr. Varun G Menon <varunmenon@scmsgroup.org> wrote:

Dear Mr. Syed Raihan-UI-Islam,

Thank you for the message. We would like to visit DIU between 10th and 14th July.

Please let us know if the date is convenient at your end. Also it would be great if you could send us an Invitation letter which could be produced for the Visa.

Let me know any further details required.

Varun

On Tuesday, June 26, 2018, International Affairs, DIU <int@daffodilvarsity.edu.bd> wrote:

Dear Dr. Varun

That is a good idea. Let us know your possible dates to visit us and sign the agreement between both of the universities.

- *With best regards*

Syed Raihan-UI-Islam

Senior Administrative Officer, International Affairs

Daffodil International University

102/1, Shukrabad, Dhanmondi, Dhaka-1207, Bangladesh.
Tel: +88 02 9138234 (Ext: 237) | Mob: +88-01811458865
WhatsApp/Viber/Wechat: +88-01920012744

On Tue, Jun 26, 2018 at 10:38 PM, Dr. Varun G Menon
<varunmenon@scmsgroup.org> wrote:

Dear Mr. Syed Raihan-UI-Islam,

Thank you for the collaboration with SCMS. We would like to visit the DIU campus on a favorable date and would like to sign the MoU with the Vice Chancellor at DIU.

We would be more than happy to host the DIU team with Vice Chancellor in our campus in future. Please let me know your thoughts.

Thanks and Regards,

Dr. Varun G Menon

Associate Professor-Computer Science Engineering
Exe. Officer-Corporate Relations & International Collaborations
SCMS School of Engineering and Technology
Kerala, India-683582
Office: +91-484-2450330 Mob: +91-8714504684
Web: <http://www.scmsgroup.org/sset/computer-science-engineering/dr-varun-g-menon>



SCMS

School of Engineering & Technology

On Tue, Jun 26, 2018 at 6:54 PM, International Affairs, DIU
<int@daffodilvarsity.edu.bd> wrote:

Dear Dr. Varun

Thank you very much for the agreement final copy. It's fine

May I request you to sign the agreement and send the copies to me either scan copy in my email or 2 original copies in my address given in my email signature

- With best regards

Syed Raihan-UI-Islam

Senior Administrative Officer, International Affairs
Daffodil International University

102/1, Shukrabad, Dhanmondi, Dhaka-1207, Bangladesh.
Tel: +88 02 9138234 (Ext: 237) | Mob: +88-01811458865
WhatsApp/Viber/Wechat: +88-01920012744

On Tue, Jun 26, 2018 at 7:01 PM, Dr. Varun G Menon
<varunmenon@scmsgroup.org> wrote:

Dear Mr. Syed Raihan-UI-Islam,

Thank you for the collaboration with SCMS. Please see the attached MoU draft approved by our Vice Chairman. Please let me know the remaining procedures including the signing of the MoU.

Thanks and Regards,

Dr. Varun G Menon

Associate Professor-Computer Science Engineering
Exe. Officer-Corporate Relations & International Collaborations
SCMS School of Engineering and Technology
Kerala, India-683582
Office: +91-484-2450330 Mob: +91-8714504684
Web: <http://www.scmsgroup.org/sset/computer-science-engineering/dr-varun-g-menon>



On Mon, Jun 25, 2018 at 3:55 PM, International Affairs, DIU
<int@daffodilvarsity.edu.bd> wrote:

Dear Dr. Varun

Thank you so much for your email and letting us know the update.

- With best regards

Syed Raihan-UI-Islam

Senior Administrative Officer, International Affairs
Daffodil International University

102/1, Shukrabad, Dhanmondi, Dhaka-1207, Bangladesh.

Tel: +88 02 9138234 (Ext: 237) | Mob: +88-01811458865

WhatsApp/Viber/Wechat: +88-01920012744

On Mon, Jun 25, 2018 at 4:14 PM, Dr. Varun G Menon

<varunmenon@scmsgroup.org> wrote:

Dear Mr. Syed Raihan-UI-Islam,

Thank you for the collaboration with SCMS. I have presented the MoU with the Vice Chairman for approval. Once the approval is obtained, I will send back the approved soft copy of the MoU.

I have discussed about the Short Term Internships for students from DIU at the Centre for Robotics, SCMS with the Director, Robotics Lab. He has promised to send me The Best Plan for DIU students within two days. I will send you the same at the earliest.

Thanks and Regards,

Dr. Varun G Menon

Associate Professor-Computer Science Engineering

Exe. Officer-Corporate Relations & International Collaborations

SCMS School of Engineering and Technology

Kerala, India-683582

Office: +91-484-2450330 Mob: +91-8714504684

Web: <http://www.scmsgroup.org/sset/computer-science-engineering/dr-varun-g-menon>



On Sun, Jun 24, 2018 at 12:56 AM, Dr. Varun G Menon

<varunmenon@scmsgroup.org> wrote:

Dear Mr. Syed Raihan-UI-Islam,

Thank you for the email. Will inform the Professor's in charge of the Cyber Security and Robotics research centers about the program plan.

Will send you the documents soon.

Have a Great Day.

Thanks and Regards,

Dr. Varun G Menon

Associate Professor-Computer Science Engineering

Exe. Officer-Corporate Relations & International Collaborations

SCMS School of Engineering and Technology
Kerala, India-683582
Office: +91-484-2450330 Mob: +91-8714504684
Web: <http://www.scmsgroup.org/sset/computer-science-engineering/dr-varun-g-menon>



SCMS
School of Engineering & Technology

On Sun, Jun 24, 2018 at 12:17 AM, International Affairs, DIU
<int@daffodilvarsity.edu.bd> wrote:

Dear Dr, Varun

Thank you very much for your quick response.

It would be great if you can share any proposal or program plan with all details, course plan, costing etc of the Summer internships based on Cyber Security and Robotics so that we could check and show to our students for interest.

Hope to receive the agreement and the program proposals soon.
Have a great day !

- With best regards

Syed Raihan-UI-Islam

Senior Administrative Officer, International Affairs

Daffodil International University

102/1, Shukrabad, Dhanmondi, Dhaka-1207, Bangladesh.

Tel: **+88 02 9138234 (Ext: 237)** | Mob: **+88-01811458865**

WhatsApp/Viber/Wechat: **+88-01920012744**

On Sun, Jun 24, 2018 at 12:35 AM, Dr. Varun G Menon

<varunmenon@scmsgroup.org> wrote:

Dear Mr. Syed Raihan-UI-Islam,

Thank you for the information about Daffodil International University. Will complete the agreement copy and send you at the earliest.

We have 5 active research groups in our Engineering College that include Centre for Robotics, Centre for Cyber Security, Hydrodynamics and Computational Fluid Dynamics, Antennas and Radiation, Centre for Sustainable Water Technology and Management. Students from your University can do summer internships and short term projects with these project groups.

Besides we also have one of the leading Management Institute in India and also Biotechnology Research Centre.

Thank you for the collaboration. Will send you the document soon.

Regards,

Dr. Varun G Menon

Associate Professor-Computer Science Engineering

Exe. Officer-Corporate Relations & International

Collaborations

SCMS School of Engineering and Technology

Kerala, India-683582

Office: +91-484-2450330 Mob: +91-8714504684

Web: <http://www.scmsgroup.org/sset/computer-science-engineering/dr-varun-g-menon>



SCMS
School of Engineering & Technology

On Sat, Jun 23, 2018 at 6:42 PM, International Affairs, DIU
<int@daffodilvarsity.edu.bd> wrote:

Dear Dr. Varun G Menon,

Greetings from DIU!

Thanks for your email and showing interest in the academic partnership. Yes, we can collaborate in the areas of student exchange programs, faculty exchange programs, summer school research collaborations, joint seminars and conferences.

I have attached here the sample agreement copy of DIU, Could you please check and fill it with your information. Besides, I have attached here the fact sheet of DIU where you can check our common details and department.

Your CSE, ECE and EEE Department can be a good prospect between both universities. Let us know your observation

Looking forward to hearing from you soon.

- With best regards

Syed Raihan-UI-Islam

**Senior Administrative Officer, International Affairs
Daffodil International University**

102/1, Shukrabad, Dhanmondi, Dhaka-1207, Bangladesh.

Tel: **+88 02 9138234 (Ext: 237)** | Mob: **+88-01811458865**

WhatsApp/Viber/Wechat: **+88-01920012744**

Respected Mr. Salahuddin Morsalin

Thank you for your time and consideration. Let me introduce as Dr. Varun G Menon, in charge of International Collaborations at SCMS Group of Educational Institutions, India.

We are interested in having academic collaboration with Daffodil International University. Collaboration could be in the areas of student exchange programs, faculty exchange programs, research collaborations, joint seminars and conferences.

We have a dedicate team of faculty and students working in areas like Robotics, Brain Signal Analysis, Computational fluid dynamics. Water Quality Monitoring and Assessment, Limnology, Water Audit, Environmental Remote Sensing , Android Malware Analysis. Research collaborations in these areas is another possibility.

We have academic collaborations with leading international universities like Vrije University-Brussels, Furtwangen University-Germany, University of Applied Sciences Ravensburg Weingarten- Germany, Shimane University- Japan and more.

Please let me know if we could discuss and take forward this initiative.

For your information we are the No 1 ranked private educational institutions in the state. You can find more information about our institutions in www.scmsgroup.org and about our Engineering Institute in www.scmsgroup.org/sset/ Have a Great Day.

Thanks and Regards,

Dr. Varun G Menon

Associate Professor-Computer Science Engineering
Exe. Officer-Corporate Relations & International Collaborations

SCMS School of Engineering and Technology
Kerala, India-683582

Office: +91-484-2450330 Mob: +91-8714504684

Web: <http://www.scmsgroup.org/sset/computer-science-engineering/dr-varun-g-menon>



SCMS

School of Engineering & Technology

--

Thanks and Regards,

Dr. Varun G Menon

Associate Professor-Computer Science Engineering
Exe. Officer-Corporate Relations & International Collaborations
SCMS School of Engineering and Technology

Kerala, India-683582

Office: +91-484-2450330 Mob: +91-8714504684

Web: <http://www.scmsgroup.org/sset/computer-science-engineering/dr-varun-g-menon>



SCMS

School of Engineering & Technology

--

Thanks and Regards,

Dr. Varun G Menon

Associate Professor-Computer Science Engineering
Exe. Officer-Corporate Relations & International Collaborations
SCMS School of Engineering and Technology

Kerala, India-683582

Office: +91-484-2450330 Mob: +91-8714504684

Web: <http://www.scmsgroup.org/sset/computer-science-engineering/dr-varun-g-menon>



SCMS
School of Engineering & Technology

--
Thanks and Regards,

Dr. Varun G Menon

Associate Professor-Computer Science Engineering

Exe. Officer-Corporate Relations & International Collaborations

SCMS School of Engineering and Technology

Kerala, India-683582

Office: +91-484-2450330 Mob: +91-8714504684

Web: <http://www.scmsgroup.org/sset/computer-science-engineering/dr-varun-g-menon>



SCMS
School of Engineering & Technology

International Affairs, DIU <int@daffodilvarsity.edu.bd>

Mon, Aug 20, 2018 at 12:27 PM

To: "Dr. Varun G Menon" <varunmenon@scmsgroup.org>

Cc: Emran Hossain <emran@daffodilvarsity.edu.bd>, "International, DIU" <international@daffodilvarsity.edu.bd>, "Office of the International Affairs, DIU" <mobility@daffodilvarsity.edu.bd>, Scholarship News <scholarship@daffodilvarsity.edu.bd>, Pramod <pramod@scmsgroup.org>, Kazi Mesbah Ur Rahman <oia@daffodilvarsity.edu.bd>, Indu Nair <indunair@scmsgroup.org>, "Dr. Praveensal C.J." <praveensal@scmsgroup.org>

Dear Dr. Varun

Thanks for letting us know. Have great and pleasant times throughout the vacation.

- With best regards

Syed Raihan-UI-Islam

Senior Administrative Officer, International Affairs

Daffodil International University

102/1, Shukrabad, Dhanmondi, Dhaka-1207, Bangladesh.

Tel: **+88 02 9138234 (Ext: 237)** | Mob: **+88-01811458865**

WhatsApp/Viber/Wechat: **+88-01920012744**

On Mon, Aug 20, 2018 at 12:44 PM, Dr. Varun G Menon <varunmenon@scmsgroup.org> wrote:

Dear Mr. Syed Raihan-UI-Islam,

Hope you are doing great. Thank you for the information on media coverage and photos of the MoU signing between SCMS and Daffodil International University.
We are having holidays till August 29th. Will send you the program details soon.
I will discuss the possibility of Visiting faculty from SCMS at DIU and will let you know.

Thanks and Regards,

Dr. Varun G Menon

Associate Professor & Head of International Relations
SCMS Group of Educational Institutions
Cochin, Kerala, India-683106
Office: +91-484-2450330 Mob: +91-8714504684
Web: <http://www.scmsgroup.org>



On Sun, Aug 19, 2018 at 3:13 PM, International Affairs, DIU <int@daffodilvarsity.edu.bd> wrote:

Dear Dr. Varun,

Greetings!

Hope you are doing well. We thank you and honorable Vice Chairman for visiting us and sign the agreement. Let us work and plan together to activate the partnership soon.

So far I remember you have some program plans that you were working to send me. Once it's ready please do send us, At the same time, we invite your faculty member to come and teach for short term period as exchange faculty. let us know the possibility

Here I attached some news coverage that published in different national daily newspapers (Both Bangla and English) about the agreement signing between DIU and SCMS group.

Have a great day!

- With best regards

Syed Raihan-UI-Islam

Senior Administrative Officer, International Affairs
Daffodil International University
102/1, Shukrabad, Dhanmondi, Dhaka-1207, Bangladesh.
Tel: **+88 02 9138234 (Ext: 237)** | Mob: **+88-01811458865**
WhatsApp/Viber/Wechat: **+88-01920012744**

On Fri, Jul 13, 2018 at 1:51 PM, International Affairs, DIU <int@daffodilvarsity.edu.bd> wrote:

Dear Dr. Varun

Yes we will arrange pick and drop for you and your Vice Chairman

- With best regards

Syed Raihan-UI-Islam

Senior Administrative Officer, International Affairs
Daffodil International University
102/1, Shukrabad, Dhanmondi, Dhaka-1207, Bangladesh.
Tel: **+88 02 9138234 (Ext: 237)** | Mob: **+88-01811458865**
WhatsApp/Viber/Wechat: **+88-01920012744**

On Thu, Jul 12, 2018 at 9:58 PM, Dr. Varun G Menon <varunmenon@scmsgroup.org> wrote:

Dear Mr. Syed Raihan-UI-Islam,

Thank you for the collaboration with SCMS.

Kindly see below the details of hotel reserved by us

Hotel Name: Best Western B/W La Vinci Hotel
Address: 54, Kawran Bazar, Dhaka, Bangladesh 1215

Please let me know if you would be arranging a pick up from the hotel to the DIU campus. We could start at 1.30 pm from the hotel to the DIU campus for the visit and signing of the MoU.

Thanks and Regards,

Dr. Varun G Menon

Associate Professor & Head of International Relations
SCMS Group of Educational Institutions
Cochin, Kerala, India-683106
Office: +91-484-2450330 Mob: +91-8714504684
Web: <http://www.scmsgroup.org>



SCMS
GROUP OF EDUCATIONAL INSTITUTIONS

On Mon, Jul 9, 2018 at 10:58 AM, International Affairs, DIU <int@daffodilvarsity.edu.bd> wrote:

Dear Dr. Varun,

Here is the address that i already gave you in whatsapp:

[Daffodil International University](#)
102/1, Shukrabad, Dhanmondi, Dhaka-1207
Bangladesh

some hotels nearby our campus:

<http://www.ambalainn.com>

<https://www.panpacific.com/en/hotels-and-resorts/pp-dhaka.html>

- With best regards

Syed Raihan-UI-Islam

Senior Administrative Officer, International Affairs
[Daffodil International University](#)
102/1, Shukrabad, Dhanmondi, Dhaka-1207, Bangladesh.
Tel: **+88 02 9138234 (Ext: 237)** | Mob: **+88-01811458865**
WhatsApp/Viber/Wechat: **+88-01920012744**

On Thu, Jul 5, 2018 at 5:25 PM, Dr. Varun G Menon <varunmenon@scmsgroup.org> wrote:

Dear Mr. Syed Raihan-UI-Islam,

Thank you for the collaboration with SCMS. Please let us know the campus address of DIU where the visit and MoU signing ceremony is planned so that we could arrange the stay in a hotel near the campus. We could see multiple campuses of DIU in the website. It would also be great if you could give the names of few good hotels near your campus.

Thanks and Regards,

Dr. Varun G Menon

Associate Professor, Computer Science Engineering
Exe. Officer, Corporate Relations & International Collaborations
SCMS School of Engineering and Technology
Kerala, India-683582
Office: +91-484-2450330 Mob: +91-8714504684
Web: <http://www.scmsgroup.org/sset/computer-science-engineering/dr-varun-g-memon>



SCMS
School of Engineering & Technology

On Tue, Jul 3, 2018 at 5:04 PM, International Affairs, DIU <int@daffodilvarsity.edu.bd> wrote:

Dear Dr. Varun

Yes Confirm so far. Thank You

- With best regards

Syed Raihan-UI-Islam

Senior Administrative Officer, International Affairs

Daffodil International University

102/1, Shukrabad, Dhanmondi, Dhaka-1207, Bangladesh.

Tel: **+88 02 9138234 (Ext: 237)** | Mob: **+88-01811458865**

WhatsApp/Viber/Wechat: **+88-01920012744**

On Tue, Jul 3, 2018 at 3:57 AM, Dr. Varun G Menon <varunmenon@scmsgroup.org> wrote:

Dear Mr. Syed Raihan-UI-Islam

Thank you for the valuable time. Please confirm the schedule as discussed and agreed earlier. No need to change the schedule. Our flight is scheduled only in the night.

- MoU Signing Ceremony and discussion session on **25th July 2018** from **3PM to 5PM**
- Visit to DIU Permanent Campus and Lunch on the on that day **9AM to 2PM**

Thanks and Regards,

Dr. Varun G Menon

Associate Professor, Computer Science Engineering

Exe. Officer, Corporate Relations & International Collaborations

SCMS School of Engineering and Technology

Kerala, India-683582

Office: +91-484-2450330 Mob: +91-8714504684

Web: <http://www.scmsgroup.org/sset/computer-science-engineering/dr-varun-g-menon>



SCMS

School of Engineering & Technology

On Sun, Jul 1, 2018 at 12:09 PM, Dr. Varun G Menon <varunmenon@scmsgroup.org> wrote:

Dear Mr. Syed Raihan-UI-Islam,

Please let me know if you can arrange the MoU signing ceremony and discussion on collaboration at DIU on **25th July morning** as we have flight back to India in the evening.

Thank you,

Dr. Varun G Menon

Associate Professor-Computer Science Engineering

Exe. Officer-Corporate Relations & International Collaborations

SCMS School of Engineering and Technology

Kerala, India-683582

Office: +91-484-2450330 Mob: +91-8714504684

Web: <http://www.scmsgroup.org/sset/computer-science-engineering/dr-varun-g-menon>



SCMS

School of Engineering & Technology

On Thu, Jun 28, 2018 at 1:32 PM, Dr. Varun G Menon <varunmenon@scmsgroup.org> wrote:

Dear Mr. Syed Raihan-UI-Islam,

Thank you for the invitation letter. Looking forward to the meeting. Will update our schedule once we confirm the flight tickets.

Thanks and Regards,

Dr. Varun G Menon

Associate Professor-Computer Science Engineering

Exe. Officer-Corporate Relations & International Collaborations

SCMS School of Engineering and Technology

Kerala, India-683582

Office: +91-484-2450330 Mob: +91-8714504684

Web: <http://www.scmsgroup.org/sset/computer-science-engineering/dr-varun-g-menon>



SCMS

School of Engineering & Technology

On Thu, Jun 28, 2018 at 1:09 PM, International Affairs, DIU <int@daffodilvarsity.edu.bd> wrote:

Dear Dr. Varun

Please find the attached letter of Invitation for both of you to visit us for the purpose of the meeting and signing the agreement.

- With best regards

Syed Raihan-UI-Islam

Senior Administrative Officer, International Affairs

Daffodil International University

102/1, Shukrabad, Dhanmondi, Dhaka-1207, Bangladesh.

Tel: **+88 02 9138234 (Ext: 237)** | Mob: **+88-01811458865**

WhatsApp/Viber/Wechat: **+88-01920012744**

On Thu, Jun 28, 2018 at 8:20 AM, Dr. Varun G Menon <varunmenon@scmsgroup.org> wrote:

Dear Mr. Syed Raihan-UI-Islam,

Please see below the details of members visiting DIU on 25th July 2018. Please send us the **invitation letter for the Visa** based on this information.

Names

Prof. **PRAMOD PRATHAPACHANDRAN THEVANNOOR**, Vice Chairman, SCMS Group of Educational Institutions.

Dr. **VARUN GIRIJAN MENON**, Associate Professor and International Relations in-charge, SCMS Group of Educational Institutions.

Address

SCMS Group of Educational Institutions

SCMS Campus, Prathap Nagar

Muttom, Aluva

Cochin – 683 106, Kerala, INDIA

Let me know any further information required.

Thanks and Regards,

Dr. Varun G Menon

Associate Professor-Computer Science Engineering

Exe. Officer-Corporate Relations & International Collaborations

SCMS School of Engineering and Technology

Kerala, India-683582

Office: +91-484-2450330 Mob: +91-8714504684

Web: <http://www.scmsgroup.org/sset/computer-science-engineering/dr-varun-g-menon>



SCMS

School of Engineering & Technology

On Wed, Jun 27, 2018 at 11:48 AM, International Affairs, DIU <int@daffodilvarsity.edu.bd> wrote:

Dear Dr. Varun

Thanks. I am looking forward.

- *With best regards*

Syed Raihan-UI-Islam

Senior Administrative Officer, International Affairs

Daffodil International University

102/1, Shukrabad, Dhanmondi, Dhaka-1207, Bangladesh.

Tel: **+88 02 9138234 (Ext: 237)** | Mob: **+88-01811458865**

WhatsApp/Viber/Wechat: **+88-01920012744**

On Wed, Jun 27, 2018 at 12:15 PM, Dr. Varun G Menon <varunmenon@scmsgroup.org> wrote:

Dear Mr. Syed Raihan-UI-Islam,

Thank you for the information. We will have the visit on 25th July. We will send the details of the members visiting the DIU campus at the earliest.

Regards

Varun

On Wednesday, June 27, 2018, International Affairs, DIU <int@daffodilvarsity.edu.bd> wrote:

Dear Dr. Varun,

I have discussed with the Office of the Vice Chancellor

We can arrange the MoU Signing Ceremony and discussion session on **25 July 2018** from **3PM to 5PM**

We can also arrange to visit our Permanent Campus and Lunch on the on that day 9AM to 2PM too.

Let us know if the time and date is convenient for your visit

Looking forward to hearing from you.

- *With best regards*

Syed Raihan-UI-Islam

Senior Administrative Officer, International Affairs

Daffodil International University

102/1, Shukrabad, Dhanmondi, Dhaka-1207, Bangladesh.

Tel: **+88 02 9138234 (Ext: 237)** | Mob: **+88-01811458865**

WhatsApp/Viber/Wechat: **+88-01920012744**

On Wed, Jun 27, 2018 at 11:18 AM, Dr. Varun G Menon <varunmenon@scmsgroup.org> wrote:

Dear Mr. Syed Raihan-UI-Islam,

Can we have the visit between July 24 and 27. Our Vice Chairman is traveling on other dates in July.

Please let me know.

Varun

On Wednesday, June 27, 2018, International Affairs, DIU <int@daffodilvarsity.edu.bd> wrote:

Dear Dr. Varun

Can we shift it to the next week I mean in between 15 to 20 July?

- *With best regards*

Syed Raihan-UI-Islam

Senior Administrative Officer, International Affairs

Daffodil International University

102/1, Shukrabad, Dhanmondi, Dhaka-1207, Bangladesh.

Tel: **+88 02 9138234 (Ext: 237)** | Mob: **+88-01811458865**WhatsApp/Viber/Wechat: **+88-01920012744**

On Wed, Jun 27, 2018 at 10:55 AM, Dr. Varun G Menon

<varunmenon@scmsgroup.org> wrote:

Dear Mr. Syed Raihan-UI-Islam,

Thank you for the message. We would like to visit DIU between 10th and 14th July. Please let us know if the date is convenient at your end. Also it would be great if you could send us an Invitation letter which could be produced for the Visa.

Let me know any further details required.

Varun

On Tuesday, June 26, 2018, International Affairs, DIU <int@daffodilvarsity.edu.bd> wrote:

Dear Dr. Varun

That is a good idea. Let us know your possible dates to visit us and sign the agreement between both of the universities.

- With best regards

Syed Raihan-UI-Islam**Senior Administrative Officer, International Affairs****Daffodil International University**

102/1, Shukrabad, Dhanmondi, Dhaka-1207, Bangladesh.

Tel: **+88 02 9138234 (Ext: 237)** | Mob: **+88-01811458865**WhatsApp/Viber/Wechat: **+88-01920012744**

On Tue, Jun 26, 2018 at 10:38 PM, Dr. Varun G Menon

<varunmenon@scmsgroup.org> wrote:

Dear Mr. Syed Raihan-UI-Islam,

Thank you for the collaboration with SCMS. We would like to visit the DIU campus on a favorable date and would like to sign the MoU with the Vice Chancellor at DIU.

We would be more than happy to host the DIU team with Vice Chancellor in our campus in future. Please let me know your thoughts.

Thanks and Regards,

Dr. Varun G Menon

Associate Professor-Computer Science Engineering

Exe. Officer-Corporate Relations & International Collaborations

SCMS School of Engineering and Technology

Kerala, India-683582

Office: +91-484-2450330 Mob: +91-8714504684

Web: <http://www.scmsgroup.org/sset/computer-science-engineering/dr-varun-g-menon>**SCMS**

School of Engineering & Technology

On Tue, Jun 26, 2018 at 6:54 PM, International Affairs, DIU

<int@daffodilvarsity.edu.bd> wrote:

Dear Dr. Varun

Thank you very much for the agreement final copy. It's fine

May I request you to sign the agreement and send the copies to me either scan copy in my email or 2 original copies in my address given in my email signature

- With best regards

Syed Raihan-UI-Islam

Senior Administrative Officer, International Affairs
Daffodil International University

102/1, Shukrabad, Dhanmondi, Dhaka-1207, Bangladesh.
Tel: **+88 02 9138234 (Ext: 237)** | Mob: **+88-01811458865**
WhatsApp/Viber/Wechat: **+88-01920012744**

On Tue, Jun 26, 2018 at 7:01 PM, Dr. Varun G Menon
<varunmenon@scmsgroup.org> wrote:

Dear Mr. Syed Raihan-UI-Islam,

Thank you for the collaboration with SCMS. Please see the attached MoU draft approved by our Vice Chairman. Please let me know the remaining procedures including the signing of the MoU.

Thanks and Regards,

Dr. Varun G Menon

Associate Professor-Computer Science Engineering
Exe. Officer-Corporate Relations & International Collaborations
SCMS School of Engineering and Technology
Kerala, India-683582
Office: +91-484-2450330 Mob: +91-8714504684
Web: <http://www.scmsgroup.org/sset/computer-science-engineering/dr-varun-g-menon>



SCMS

School of Engineering & Technology

On Mon, Jun 25, 2018 at 3:55 PM, International Affairs, DIU
<int@daffodilvarsity.edu.bd> wrote:

Dear Dr. Varun

Thank you so much for your email and letting us know the update.

- With best regards

Syed Raihan-UI-Islam

Senior Administrative Officer, International Affairs
Daffodil International University

102/1, Shukrabad, Dhanmondi, Dhaka-1207, Bangladesh.
Tel: **+88 02 9138234 (Ext: 237)** | Mob: **+88-01811458865**
WhatsApp/Viber/Wechat: **+88-01920012744**

On Mon, Jun 25, 2018 at 4:14 PM, Dr. Varun G Menon
<varunmenon@scmsgroup.org> wrote:

Dear Mr. Syed Raihan-UI-Islam,

Thank you for the collaboration with SCMS. I have presented the MoU with the Vice Chairman for approval. Once the approval is obtained, I will send back the approved soft copy of the MoU. I have discussed about the Short Term Internships for students from DIU at the Centre for Robotics, SCMS with the Director, Robotics Lab. He has promised to send me The Best Plan for DIU students within two days. I will send you the same at the earliest.

Thanks and Regards,

Dr. Varun G Menon

Associate Professor-Computer Science Engineering
Exe. Officer-Corporate Relations & International Collaborations
SCMS School of Engineering and Technology

Kerala, India-683582

Office: +91-484-2450330 Mob: +91-8714504684

Web: <http://www.scmsgroup.org/sset/computer-science-engineering/dr-varun-g-menon>



SCMS

School of Engineering & Technology

On Sun, Jun 24, 2018 at 12:56 AM, Dr. Varun G Menon

<varunmenon@scmsgroup.org> wrote:

Dear Mr. Syed Raihan-UI-Islam,

Thank you for the email. Will inform the Professor's in charge of the Cyber Security and Robotics research centers about the program plan.

Will sent you the documents soon.

Have a Great Day.

Thanks and Regards,

Dr. Varun G Menon

Associate Professor-Computer Science Engineering

Exe. Officer-Corporate Relations & International

Collaborations

SCMS School of Engineering and Technology

Kerala, India-683582

Office: +91-484-2450330 Mob: +91-8714504684

Web: <http://www.scmsgroup.org/sset/computer-science-engineering/dr-varun-g-menon>



SCMS

School of Engineering & Technology

On Sun, Jun 24, 2018 at 12:17 AM, International Affairs, DIU

<int@daffodilvarsity.edu.bd> wrote:

Dear Dr, Varun

Thank you very much for your quick response.

It would be great if you can share any proposal or program plan with all details, course plan, costing etc of the Summer internships based on Cyber Security and Robotics so that we could check and show t our students for interest.

Hope to receive the agreement and the program proposals soon.
Have a great day !

- With best regards

Syed Raihan-UI-Islam

Senior Administrative Officer, International Affairs

Daffodil International University

102/1, Shukrabad, Dhanmondi, Dhaka-1207, Bangladesh.

Tel: **+88 02 9138234 (Ext: 237)** | Mob: **+88-01811458865**

WhatsApp/Viber/Wechat: **+88-01920012744**

On Sun, Jun 24, 2018 at 12:35 AM, Dr. Varun G Menon

<varunmenon@scmsgroup.org> wrote:

Dear Mr. Syed Raihan-UI-Islam,

Thank you for the information about Daffodil International University. Will complete the agreement copy and send you at the earliest.

We have 5 active research groups in our Engineering College that include Centre for Robotics, Centre for Cyber Security, Hydrodynamics and Computational Fluid Dynamics, Antennas and Radiation, Centre for Sustainable Water Technology and Management. Students from your University can do summer internships and short term projects with these project groups.

Besides we also have one of the leading Management Institute in India and also Biotechnology Research Centre.

Thank you for the collaboration. Will send you the document soon.

Regards,

Dr. Varun G Menon

Associate Professor-Computer Science Engineering
Exe. Officer-Corporate Relations & International Collaborations
SCMS School of Engineering and Technology
Kerala, India-683582
Office: +91-484-2450330 Mob: +91-8714504684
Web: <http://www.scmsgroup.org/sset/computer-science-engineering/dr-varun-g-menon>



SCMS

School of Engineering & Technology

On Sat, Jun 23, 2018 at 6:42 PM, International Affairs, DIU <int@daffodilvarsity.edu.bd> wrote:

Dear Dr. Varun G Menon,

Greetings from DIU!

Thanks for your email and showing interest in the academic partnership. Yes, we can collaborate in the areas of student exchange programs, faculty exchange programs, summer school research collaborations, joint seminars and conferences.

I have attached here the sample agreement copy of DIU, Could you please check and fill it with your information. Besides, I have attached here the fact sheet of DIU where you can check our common details and department.

Your CSE, ECE and EEE Department can be a good prospect between both universities. Let us know your observation

Looking forward to hearing from you soon.

- With best regards

Syed Raihan-UI-Islam

**Senior Administrative Officer, International Affairs
Daffodil International University**

102/1, Shukrabad, Dhanmondi, Dhaka-1207, Bangladesh.

Tel: **+88 02 9138234 (Ext: 237)** | Mob: **+88-01811458865**

WhatsApp/Viber/Wechat: **+88-01920012744**

Respected Mr. Salahuddin Morsalin

Thank you for your time and consideration. Let me introduce as Dr. Varun G Menon, in charge of International Collaborations at SCMS Group of Educational Institutions, India.

We are interested in having academic collaboration with Daffodil International University. Collaboration could be in the areas of student exchange programs, faculty exchange programs, research collaborations, joint seminars and conferences.

We have a dedicate team of faculty and students working in areas like Robotics, Brain Signal Analysis, Computational fluid dynamics. Water Quality Monitoring and Assessment, Limnology, Water Audit, Environmental Remote Sensing , Android Malware Analysis. Research collaborations in these areas is another possibility.

We have academic collaborations with leading international universities like Vrije University-Brussels, Furtwangen University-Germany, University of Applied Sciences Ravensburg Weingarten- Germany, Shimane University-Japan and more.

Please let me know if we could discuss and take forward this initiative.

For your information we are the No 1 ranked private educational institutions in the state. You can find more information about our institutions in www.scmsgroup.org and about our Engineering Institute in www.scmsgroup.org/sset/
Have a Great Day.

Thanks and Regards,

Dr. Varun G Menon

Associate Professor-Computer Science Engineering
Exe. Officer-Corporate Relations & International Collaborations
SCMS School of Engineering and Technology
Kerala, India-683582
Office: +91-484-2450330 Mob: +91-8714504684
Web: <http://www.scmsgroup.org/sset/computer-science-engineering/dr-varun-g-memon>



SCMS
School of Engineering & Technology

--

Thanks and Regards,

Dr. Varun G Menon

Associate Professor-Computer Science Engineering
Exe. Officer-Corporate Relations & International Collaborations
SCMS School of Engineering and Technology

Kerala, India-683582

Office: +91-484-2450330 Mob: +91-8714504684

Web: <http://www.scmsgroup.org/sset/computer-science-engineering/dr-varun-g-menon>



SCMS

School of Engineering & Technology

--

Thanks and Regards,

Dr. Varun G Menon

Associate Professor-Computer Science Engineering
Exe. Officer-Corporate Relations & International Collaborations
SCMS School of Engineering and Technology

Kerala, India-683582

Office: +91-484-2450330 Mob: +91-8714504684

Web: <http://www.scmsgroup.org/sset/computer-science-engineering/dr-varun-g-menon>



SCMS

School of Engineering & Technology

--

Thanks and Regards,

Dr. Varun G Menon

Associate Professor-Computer Science Engineering
Exe. Officer-Corporate Relations & International Collaborations
SCMS School of Engineering and Technology

Kerala, India-683582

Office: +91-484-2450330 Mob: +91-8714504684

Web: <http://www.scmsgroup.org/sset/computer-science-engineering/dr-varun-g-menon>



SCMS

School of Engineering & Technology

International Affairs, DIU <int@daffodilvarsity.edu.bd>

Wed, Oct 3, 2018 at 1:09 AM

To: "Dr. Varun G Menon" <varunmenon@scmsgroup.org>

Cc: Emran Hossain <emran@daffodilvarsity.edu.bd>, "International, DIU" <international@daffodilvarsity.edu.bd>, "Office of the International Affairs, DIU" <mobility@daffodilvarsity.edu.bd>, Scholarship News <scholarship@daffodilvarsity.edu.bd>, Pramod <pramod@scmsgroup.org>, Kazi Mesbah Ur Rahman <oia@daffodilvarsity.edu.bd>, Indu Nair <indunair@scmsgroup.org>, "Dr. Praveensal C.J." <praveensal@scmsgroup.org>

Dear Dr. Varun

I am looking forward to hear from you to activate our partnership through some exchanges and visit plans.

Let us know your observations.

- *With best regards*

Syed Raihan-UI-Islam

Senior Administrative Officer, International Affairs

Daffodil International University

102/1, Shukrabad, Dhanmondi, Dhaka-1207, Bangladesh.

Tel: **+88 02 9138234 (Ext: 237)** | Mob: **+88-01811458865**

WhatsApp/Viber/Wechat: **+88-01920012744**

On Mon, Aug 20, 2018 at 12:57 PM, International Affairs, DIU <int@daffodilvarsity.edu.bd> wrote:

Dear Dr. Varun

Thanks for letting us know. Have great and pleasant times throughout the vacation.

- *With best regards*

Syed Raihan-UI-Islam

Senior Administrative Officer, International Affairs

Daffodil International University

102/1, Shukrabad, Dhanmondi, Dhaka-1207, Bangladesh.

Tel: **+88 02 9138234 (Ext: 237)** | Mob: **+88-01811458865**

WhatsApp/Viber/Wechat: **+88-01920012744**

On Mon, Aug 20, 2018 at 12:44 PM, Dr. Varun G Menon <varunmenon@scmsgroup.org> wrote:

Dear Mr. Syed Raihan-UI-Islam,

Hope you are doing great. Thank you for the information on media coverage and photos of the MoU signing between SCMS and Daffodil International University.

We are having holidays till August 29th. Will send you the program details soon.

I will discuss the possibility of Visiting faculty from SCMS at DIU and will let you know.

Thanks and Regards,

Dr. Varun G Menon

Associate Professor & Head of International Relations

SCMS Group of Educational Institutions

Cochin, Kerala, India-683106

Office: +91-484-2450330 Mob: +91-8714504684

Web: <http://www.scmsgroup.org>



SCMS

GROUP OF EDUCATIONAL INSTITUTIONS

On Sun, Aug 19, 2018 at 3:13 PM, International Affairs, DIU <int@daffodilvarsity.edu.bd> wrote:

Dear Dr. Varun,

Greetings!

Hope you are doing well. We thank you and honorable Vice Chairman for visiting us and sign the agreement. Let us work and plan together to activate the partnership soon.

So far I remember you have some program plans that you were working to send me. Once it's ready please do send us, At the same time, we invite your faculty member to come and teach for short term period as exchange faculty. let us know the possibility

Here I attached some news coverage that published in different national daily newspapers (Both Bangla and English) about the agreement signing between DIU and SCMS group.

Have a great day!

- With best regards

Syed Raihan-UI-Islam

Senior Administrative Officer, International Affairs
Daffodil International University

102/1, Shukrabad, Dhanmondi, Dhaka-1207, Bangladesh.

Tel: **+88 02 9138234 (Ext: 237)** | Mob: **+88-01811458865**

WhatsApp/Viber/Wechat: **+88-01920012744**

On Fri, Jul 13, 2018 at 1:51 PM, International Affairs, DIU <int@daffodilvarsity.edu.bd> wrote:

Dear Dr. Varun

Yes we will arrange pick and drop for you and your Vice Chairman

- With best regards

Syed Raihan-UI-Islam

Senior Administrative Officer, International Affairs
Daffodil International University

102/1, Shukrabad, Dhanmondi, Dhaka-1207, Bangladesh.

Tel: **+88 02 9138234 (Ext: 237)** | Mob: **+88-01811458865**

WhatsApp/Viber/Wechat: **+88-01920012744**

On Thu, Jul 12, 2018 at 9:58 PM, Dr. Varun G Menon <varunmenon@scmsgroup.org> wrote:

Dear Mr. Syed Raihan-UI-Islam,

Thank you for the collaboration with SCMS.

Kindly see below the details of hotel reserved by us

Hotel Name: Best Western B/W La Vinci Hotel
Address: 54, Kawran Bazar, Dhaka, Bangladesh 1215

Please let me know if you would be arranging a pick up from the hotel to the DIU campus. We could start at 1.30 pm from the hotel to the DIU campus for the visit and signing of the MoU.

Thanks and Regards,

Dr. Varun G Menon

Associate Professor & Head of International Relations

SCMS Group of Educational Institutions

Cochin, Kerala, India-683106

Office: +91-484-2450330 Mob: +91-8714504684

Web: <http://www.scmsgroup.org>



SCMS
GROUP OF EDUCATIONAL INSTITUTIONS

On Mon, Jul 9, 2018 at 10:58 AM, International Affairs, DIU <int@daffodilvarsity.edu.bd> wrote:

Dear Dr. Varun,

Here is the address that i already gave you in whatsapp:

Daffodil International University
102/1, Shukrabad, Dhanmondi, Dhaka-1207
Bangladesh

some hotels nearby our campus:

<http://www.ambalainn.com>

<https://www.panpacific.com/en/hotels-and-resorts/pp-dhaka.html>

- With best regards

Syed Raihan-UI-Islam

Senior Administrative Officer, International Affairs

Daffodil International University

102/1, Shukrabad, Dhanmondi, Dhaka-1207, Bangladesh.

Tel: **+88 02 9138234 (Ext: 237)** | Mob: **+88-01811458865**

WhatsApp/Viber/Wechat: **+88-01920012744**

On Thu, Jul 5, 2018 at 5:25 PM, Dr. Varun G Menon <varunmenon@scmsgroup.org> wrote:

Dear Mr. Syed Raihan-UI-Islam,

Thank you for the collaboration with SCMS. Please let us know the campus address of DIU where the visit and MoU signing ceremony is planned so that we could arrange the stay in a hotel near the campus. We could see multiple campuses of DIU in the website. It would also be great if you could give the names of few good hotels near your campus.

Thanks and Regards,

Dr. Varun G Menon

Associate Professor, Computer Science Engineering

Exe. Officer, Corporate Relations & International Collaborations

SCMS School of Engineering and Technology

Kerala, India-683582

Office: +91-484-2450330 Mob: +91-8714504684

Web: <http://www.scmsgroup.org/sset/computer-science-engineering/dr-varun-g-menon>



SCMS

School of Engineering & Technology

On Tue, Jul 3, 2018 at 5:04 PM, International Affairs, DIU <int@daffodilvarsity.edu.bd> wrote:

Dear Dr. Varun

Yes Confirm so far. Thank You

- With best regards

Syed Raihan-UI-Islam

Senior Administrative Officer, International Affairs

Daffodil International University

102/1, Shukrabad, Dhanmondi, Dhaka-1207, Bangladesh.

Tel: **+88 02 9138234 (Ext: 237)** | Mob: **+88-01811458865**

WhatsApp/Viber/Wechat: **+88-01920012744**

On Tue, Jul 3, 2018 at 3:57 AM, Dr. Varun G Menon <varunmenon@scmsgroup.org> wrote:

Dear Mr. Syed Raihan-UI-Islam

Thank you for the valuable time. Please confirm the schedule as discussed and agreed earlier. No need to change the schedule. Our flight is scheduled only in the night.

- MoU Signing Ceremony and discussion session on **25th July 2018** from **3PM to 5PM**
- Visit to DIU Permanent Campus and Lunch on the on that day **9AM to 2PM**

Thanks and Regards,

Dr. Varun G Menon

Associate Professor, Computer Science Engineering

Exe. Officer, Corporate Relations & International Collaborations

SCMS School of Engineering and Technology

Kerala, India-683582

Office: +91-484-2450330 Mob: +91-8714504684

Web: <http://www.scmsgroup.org/sset/computer-science-engineering/dr-varun-g-menon>



SCMS

School of Engineering & Technology

On Sun, Jul 1, 2018 at 12:09 PM, Dr. Varun G Menon <varunmenon@scmsgroup.org> wrote:

Dear Mr. Syed Raihan-UI-Islam,

Please let me know if you can arrange the MoU signing ceremony and discussion on collaboration at DIU on **25th July morning** as we have flight back to India in the evening.

Thank you,

Dr. Varun G Menon

Associate Professor-Computer Science Engineering

Exe. Officer-Corporate Relations & International Collaborations

SCMS School of Engineering and Technology

Kerala, India-683582

Office: +91-484-2450330 Mob: +91-8714504684

Web: <http://www.scmsgroup.org/sset/computer-science-engineering/dr-varun-g-menon>



SCMS

School of Engineering & Technology

On Thu, Jun 28, 2018 at 1:32 PM, Dr. Varun G Menon <varunmenon@scmsgroup.org> wrote:

Dear Mr. Syed Raihan-UI-Islam,

Thank you for the invitation letter. Looking forward to the meeting. Will update our schedule once we confirm the flight tickets.

Thanks and Regards,

Dr. Varun G Menon

Associate Professor-Computer Science Engineering

Exe. Officer-Corporate Relations & International Collaborations

SCMS School of Engineering and Technology

Kerala, India-683582

Office: +91-484-2450330 Mob: +91-8714504684

Web: <http://www.scmsgroup.org/sset/computer-science-engineering/dr-varun-g-menon>



SCMS

School of Engineering & Technology

On Thu, Jun 28, 2018 at 1:09 PM, International Affairs, DIU <int@daffodilvarsity.edu.bd> wrote:

Dear Dr. Varun

Please find the attached letter of Invitation for both of you to visit us for the purpose of the meeting and signing the agreement.

- With best regards

Syed Raihan-UI-Islam

Senior Administrative Officer, International Affairs

Daffodil International University

102/1, Shukrabad, Dhanmondi, Dhaka-1207, Bangladesh.

Tel: **+88 02 9138234 (Ext: 237)** | Mob: **+88-01811458865**WhatsApp/Viber/Wechat: **+88-01920012744**

On Thu, Jun 28, 2018 at 8:20 AM, Dr. Varun G Menon <varunmenon@scmsgroup.org> wrote:
Dear Mr. Syed Raihan-UI-Islam,

Please see below the details of members visiting DIU on 25th July 2018. Please send us the **invitation letter for the Visa** based on this information.

Names

Prof. **PRAMOD PRATHAPACHANDRAN THEVANNOOR**, Vice Chairman, SCMS Group of Educational Institutions.

Dr. **VARUN GIRIJAN MENON**, Associate Professor and International Relations in-charge, SCMS Group of Educational Institutions.

Address

SCMS Group of Educational Institutions
SCMS Campus, Prathap Nagar
Muttom, Aluva
Cochin – 683 106, Kerala, INDIA

Let me know any further information required.

Thanks and Regards,

Dr. Varun G Menon

Associate Professor-Computer Science Engineering
Exe. Officer-Corporate Relations & International Collaborations
SCMS School of Engineering and Technology
Kerala, India-683582
Office: +91-484-2450330 Mob: +91-8714504684
Web: <http://www.scmsgroup.org/sset/computer-science-engineering/dr-varun-g-menon>



SCMS
School of Engineering & Technology

On Wed, Jun 27, 2018 at 11:48 AM, International Affairs, DIU <int@daffodilvarsity.edu.bd> wrote:
Dear Dr. Varun

Thanks. I am looking forward.

- *With best regards*

Syed Raihan-UI-Islam

Senior Administrative Officer, International Affairs

Daffodil International University

102/1, Shukrabad, Dhanmondi, Dhaka-1207, Bangladesh.

Tel: **+88 02 9138234 (Ext: 237)** | Mob: **+88-01811458865**WhatsApp/Viber/Wechat: **+88-01920012744**

On Wed, Jun 27, 2018 at 12:15 PM, Dr. Varun G Menon <varunmenon@scmsgroup.org> wrote:

Dear Mr. Syed Raihan-UI-Islam,

Thank you for the information. We will have the visit on 25th July. We will send the details of the members visiting the DIU campus at the earliest.

Regards

Varun

On Wednesday, June 27, 2018, International Affairs, DIU <int@daffodilvarsity.edu.bd> wrote:

Dear Dr. Varun,

I have discussed with the Office of the Vice Chancellor

We can arrange the MoU Signing Ceremony and discussion session on **25 July 2018** from **3PM to 5PM**

We can also arrange to visit our Permanent Campus and Lunch on the on that day 9AM to 2PM too.

Let us know if the time and date is convenient for your visit

Looking forward to hearing from you.

- *With best regards*

Syed Raihan-UI-Islam

Senior Administrative Officer, International Affairs

Daffodil International University

102/1, Shukrabad, Dhanmondi, Dhaka-1207, Bangladesh.

Tel: **+88 02 9138234 (Ext: 237)** | Mob: **+88-01811458865**

WhatsApp/Viber/Wechat: **+88-01920012744**

On Wed, Jun 27, 2018 at 11:18 AM, Dr. Varun G Menon <varunmenon@scmsgroup.org> wrote:

Dear Mr. Syed Raihan-UI-Islam,

Can we have the visit between July 24 and 27. Our Vice Chairman is traveling on other dates in July.

Please let me know.

Varun

On Wednesday, June 27, 2018, International Affairs, DIU <int@daffodilvarsity.edu.bd> wrote:

Dear Dr. Varun

Can we shift it to the next week I mean in between 15 to 20 July?

- *With best regards*

Syed Raihan-UI-Islam

Senior Administrative Officer, International Affairs

Daffodil International University

102/1, Shukrabad, Dhanmondi, Dhaka-1207, Bangladesh.

Tel: **+88 02 9138234 (Ext: 237)** | Mob: **+88-01811458865**

WhatsApp/Viber/Wechat: **+88-01920012744**

On Wed, Jun 27, 2018 at 10:55 AM, Dr. Varun G Menon

<varunmenon@scmsgroup.org> wrote:

Dear Mr. Syed Raihan-UI-Islam,

Thank you for the message. We would like to visit DIU between 10th and 14th July.

Please let us know if the date is convenient at your end. Also it would be great if you could send us an Invitation letter which could be produced for the Visa.

Let me know any further details required.

Varun

On Tuesday, June 26, 2018, International Affairs, DIU <int@daffodilvarsity.edu.bd>

wrote:

Dear Dr. Varun

That is a good idea. Let us know your possible dates to visit us and sign the agreement between both of the universities.

- *With best regards*

Syed Raihan-UI-Islam

Senior Administrative Officer, International Affairs

Daffodil International University

102/1, Shukrabad, Dhanmondi, Dhaka-1207, Bangladesh.

Tel: **+88 02 9138234 (Ext: 237)** | Mob: **+88-01811458865**

WhatsApp/Viber/Wechat: **+88-01920012744**

On Tue, Jun 26, 2018 at 10:38 PM, Dr. Varun G Menon

<varunmenon@scmsgroup.org> wrote:

Dear Mr. Syed Raihan-UI-Islam,

Thank you for the collaboration with SCMS. We would like to visit the DIU campus on a favorable date and would like to sign the MoU with the Vice Chancellor at DIU.

We would be more than happy to host the DIU team with Vice Chancellor in our campus in future. Please let me know your thoughts.

Thanks and Regards,

Dr. Varun G Menon

Associate Professor-Computer Science Engineering

Exe. Officer-Corporate Relations & International Collaborations

SCMS School of Engineering and Technology

Kerala, India-683582

Office: +91-484-2450330 Mob: +91-8714504684

Web: <http://www.scmsgroup.org/sset/computer-science-engineering/dr-varun-g-menon>



SCMS

School of Engineering & Technology

On Tue, Jun 26, 2018 at 6:54 PM, International Affairs, DIU

<int@daffodilvarsity.edu.bd> wrote:

Dear Dr. Varun

Thank you very much for the agreement final copy. It's fine

May I request you to sign the agreement and send the copies to me either scan copy in my email or 2 original copies in my address given in my email signature

- With best regards

Syed Raihan-UI-Islam

Senior Administrative Officer, International Affairs

Daffodil International University

102/1, Shukrabad, Dhanmondi, Dhaka-1207, Bangladesh.

Tel: **+88 02 9138234 (Ext: 237)** | Mob: **+88-01811458865**

WhatsApp/Viber/Wechat: **+88-01920012744**

On Tue, Jun 26, 2018 at 7:01 PM, Dr. Varun G Menon

<varunmenon@scmsgroup.org> wrote:

Dear Mr. Syed Raihan-UI-Islam,

Thank you for the collaboration with SCMS. Please see the attached MoU draft approved by our Vice Chairman. Please let me know the remaining procedures including the signing of the MoU.

Thanks and Regards,

Dr. Varun G Menon

Associate Professor-Computer Science Engineering

Exe. Officer-Corporate Relations & International Collaborations

SCMS School of Engineering and Technology

Kerala, India-683582

Office: +91-484-2450330 Mob: +91-8714504684

Web: <http://www.scmsgroup.org/sset/computer-science-engineering/dr-varun-g-menon>



SCMS
School of Engineering & Technology

On Mon, Jun 25, 2018 at 3:55 PM, International Affairs, DIU
<int@daffodilvarsity.edu.bd> wrote:

Dear Dr. Varun

Thank you so much for your email and letting us know the update.

- With best regards

Syed Raihan-UI-Islam

Senior Administrative Officer, International Affairs
Daffodil International University

102/1, Shukrabad, Dhanmondi, Dhaka-1207, Bangladesh.

Tel: **+88 02 9138234 (Ext: 237)** | Mob: **+88-01811458865**

WhatsApp/Viber/Wechat: **+88-01920012744**

On Mon, Jun 25, 2018 at 4:14 PM, Dr. Varun G Menon
<varunmenon@scmsgroup.org> wrote:

Dear Mr. Syed Raihan-UI-Islam,

Thank you for the collaboration with SCMS. I have presented the MoU with the Vice Chairman for approval. Once the approval is obtained, I will send back the approved soft copy of the MoU. I have discussed about the Short Term Internships for students from DIU at the Centre for Robotics, SCMS with the Director, Robotics Lab. He has promised to send me The Best Plan for DIU students within two days. I will send you the same at the earliest.

Thanks and Regards,

Dr. Varun G Menon

Associate Professor-Computer Science Engineering
Exe. Officer-Corporate Relations & International Collaborations
SCMS School of Engineering and Technology
Kerala, India-683582

Office: +91-484-2450330 Mob: +91-8714504684

Web: <http://www.scmsgroup.org/sset/computer-science-engineering/dr-varun-g-menon>



SCMS
School of Engineering & Technology

On Sun, Jun 24, 2018 at 12:56 AM, Dr. Varun G Menon
<varunmenon@scmsgroup.org> wrote:

Dear Mr. Syed Raihan-UI-Islam,

Thank you for the email. Will inform the Professor's in charge of the Cyber Security and Robotics research centers about the program plan.

Will sent you the documents soon.

Have a Great Day.

Thanks and Regards,

Dr. Varun G Menon

Associate Professor-Computer Science Engineering
Exe. Officer-Corporate Relations & International
Collaborations
SCMS School of Engineering and Technology
Kerala, India-683582
Office: +91-484-2450330 Mob: +91-8714504684
Web: <http://www.scmsgroup.org/sset/computer-science-engineering/dr-varun-g-menon>



SCMS
School of Engineering & Technology

On Sun, Jun 24, 2018 at 12:17 AM, International Affairs, DIU
<int@daffodilvarsity.edu.bd> wrote:

Dear Dr, Varun

Thank you very much for your quick response.

It would be great if you can share any proposal or program plan with all details, course plan, costing etc of the Summer internships based on Cyber Security and Robotics so that we could check and show t our students for interest.

Hope to receive the agreement and the program proposals soon. Have a great day !

- *With best regards*

Syed Raihan-UI-Islam

Senior Administrative Officer, [International Affairs](#)
[Daffodil International University](#)

102/1, Shukrabad, Dhanmondi, Dhaka-1207, Bangladesh.

Tel: **+88 02 9138234 (Ext: 237)** | Mob: +88-

01811458865

WhatsApp/Viber/Wechat: **+88-01920012744**

On Sun, Jun 24, 2018 at 12:35 AM, Dr. Varun G Menon

<varunmenon@scmsgroup.org> wrote:

Dear Mr. Syed Raihan-UI-Islam,

Thank you for the information about Daffodil International University. Will complete the agreement copy and send you at the earliest.

We have 5 active research groups in our Engineering College that include Centre for Robotics, Centre for Cyber Security, Hydrodynamics and Computational Fluid Dynamics, Antennas and Radiation, Centre for Sustainable Water Technology and Management. Students from your University can do summer internships and short term projects with these project groups.

Besides we also have one of the leading Management Institute in India and also Biotechnology Research Centre.

Thank you for the collaboration. Will send you the document soon.

Regards,

Dr. Varun G Menon

Associate Professor-Computer Science Engineering
Exe. Officer-Corporate Relations & International
Collaborations

SCMS School of Engineering and Technology
Kerala, India-683582

Office: +91-484-2450330 Mob: +91-8714504684
Web: <http://www.scmsgroup.org/sset/computer-science-engineering/dr-varun-g-menon>



SCMS
School of Engineering & Technology

On Sat, Jun 23, 2018 at 6:42 PM, International Affairs, DIU
<int@daffodilvarsity.edu.bd> wrote:

Dear Dr. Varun G Menon,

Greetings from DIU!

Thanks for your email and showing interest in the academic partnership. Yes, we can collaborate in the areas of student exchange programs, faculty exchange programs, summer school research collaborations, joint seminars and conferences.

I have attached here the sample agreement copy of DIU, Could you please check and fill it with your information. Besides, I have attached here the fact sheet of DIU where you can check our common details and department.

Your CSE, ECE and EEE Department can be a good prospect between both universities. Let us know your observation

Looking forward to hearing from you soon.

- With best regards

Syed Raihan-UI-Islam

**Senior Administrative Officer, International Affairs
Daffodil International University**

102/1, Shukrabad, Dhanmondi, Dhaka-1207, Bangladesh.

Tel: **+88 02 9138234 (Ext: 237)** | Mob: **+88-01811458865**

WhatsApp/Viber/Wechat: **+88-01920012744**

Respected Mr. Salahuddin Morsalin

Thank you for your time and consideration. Let me introduce as Dr. Varun G Menon, in charge of International Collaborations at SCMS Group of Educational Institutions, India.

We are interested in having academic collaboration with Daffodil International University. Collaboration could be in the areas of student exchange programs, faculty exchange programs, research collaborations, joint seminars and conferences.

We have a dedicate team of faculty and students working in areas like Robotics, Brain Signal Analysis, Computational fluid dynamics. Water Quality Monitoring and Assessment, Limnology, Water Audit, Environmental Remote Sensing , Android Malware Analysis. Research collaborations in these areas is another possibility.

We have academic collaborations with leading international universities like Vrije University-Brussels, Furtwangen University-Germany, University of Applied Sciences Ravensburg Weingarten- Germany, Shimane University-Japan and more.

Please let me know if we could discuss and take forward this initiative.

For your information we are the No 1 ranked private educational institutions in the state. You can find more information about our institutions in www.scmsgroup.org and about our Engineering Institute in www.scmsgroup.org/sset/
Have a Great Day.

Thanks and Regards,

Dr. Varun G Menon

Associate Professor-Computer Science Engineering
Exe. Officer-Corporate Relations & International Collaborations
SCMS School of Engineering and Technology
Kerala, India-683582
Office: +91-484-2450330 Mob: +91-8714504684
Web: <http://www.scmsgroup.org/sset/computer-science-engineering/dr-varun-g-menon>



SCMS

School of Engineering & Technology

--

Thanks and Regards,

Dr. Varun G Menon

Associate Professor-Computer Science Engineering
Exe. Officer-Corporate Relations & International Collaborations
SCMS School of Engineering and Technology
Kerala, India-683582
Office: +91-484-2450330 Mob: +91-8714504684
Web: <http://www.scmsgroup.org/sset/computer-science-engineering/dr-varun-g-menon>



SCMS

School of Engineering & Technology

--

Thanks and Regards,

Dr. Varun G Menon

Associate Professor-Computer Science Engineering
Exe. Officer-Corporate Relations & International Collaborations
SCMS School of Engineering and Technology
Kerala, India-683582
Office: +91-484-2450330 Mob: +91-8714504684
Web: <http://www.scmsgroup.org/sset/computer-science-engineering/dr-varun-g-menon>

**SCMS**

School of Engineering & Technology

--
Thanks and Regards,

Dr. Varun G Menon

Associate Professor-Computer Science Engineering
Exe. Officer-Corporate Relations & International Collaborations
SCMS School of Engineering and Technology
Kerala, India-683582
Office: +91-484-2450330 Mob: +91-8714504684
Web: <http://www.scmsgroup.org/sset/computer-science-engineering/dr-varun-g-menon>

**SCMS**

School of Engineering & Technology

Dr. Varun G Menon <varunmenon@scmsgroup.org>

Thu, Nov 1, 2018 at 9:09 AM

To: "International Affairs, DIU" <int@daffodilvarsity.edu.bd>

Cc: Emran Hossain <emran@daffodilvarsity.edu.bd>, "International, DIU" <international@daffodilvarsity.edu.bd>, "Office of the International Affairs, DIU" <mobility@daffodilvarsity.edu.bd>, Scholarship News <scholarship@daffodilvarsity.edu.bd>, Pramod <pramod@scmsgroup.org>, Kazi Mesbah Ur Rahman <oia@daffodilvarsity.edu.bd>, "Dr. Praveensal C.J." <praveensal@scmsgroup.org>, Sunil Jacob <suniljacob@scmsgroup.org>, Gopakumar S <gopakumars@scmsgroup.org>

Dear Mr. Syed Raihan-UI-Islam,

Thank you for the partnership with SCMS.

As requested, please see the attached program plan of the Internship program at Centre for Robotics, SCMS School of Engineering and Technology.

The program has been customized for the Engineering students at DIU.

Please feel free to contact me for any clarifications.

Thanks and Regards,

Dr. Varun G Menon

Associate Professor and Head of International Relations
SCMS School of Engineering and Technology
Karukutty, Ernakulam, Kerala, India - 683 582

[Quoted text hidden]

 **Internship at SCMS for Daffodil University Students.pdf**
265K

Sunil Jacob <suniljacob@scmsgroup.org>

Thu, Nov 1, 2018 at 9:09 AM

To: Varun Menon G <varunmenon@scmsgroup.org>

Cc: int@daffodilvarsity.edu.bd, emran@daffodilvarsity.edu.bd, international@daffodilvarsity.edu.bd, mobility@daffodilvarsity.edu.bd, scholarship@daffodilvarsity.edu.bd, Pramod P Thevannoor <pramod@scmsgroup.org>, oia@daffodilvarsity.edu.bd, "Dr. Praveensal C.J." <praveensal@scmsgroup.org>, Gopakumar S <gopakumars@scmsgroup.org>

Received, thank you.

[Quoted text hidden]

--

Regards,
Dr. Sunil Jacob
Director SCMS Centre for Robotics
Professor Electronics and Communication Engineering Department



SCMS
School of Engineering & Technology

SCMS School of Engineering & Technology
Karukutty, Cochin - 683 582
Kerala
India

International Affairs, DIU <int@daffodilvarsity.edu.bd>

Tue, Dec 4, 2018 at 8:35 PM

To: "Dr. Varun G Menon" <varunmenon@scmsgroup.org>

Cc: Emran Hossain <emran@daffodilvarsity.edu.bd>, "International, DIU" <international@daffodilvarsity.edu.bd>, "Office of the International Affairs, DIU" <mobility@daffodilvarsity.edu.bd>, Scholarship News <scholarship@daffodilvarsity.edu.bd>, Pramod <pramod@scmsgroup.org>, Kazi Mesbah Ur Rahman <oia@daffodilvarsity.edu.bd>, "Dr. Praveensal C.J." <praveensal@scmsgroup.org>, suniljacob@scmsgroup.org, gopakumars@scmsgroup.org

Dear Dr. Varun,

I got feedback from the departments

We can send a group of 4 students (after successful application by students) to you to attend the program.

The Department suggested the following with industry or factory tour:

Lesson 1: Introduction
Lesson 2: Sensors, actuators, and drivers
Lesson 3: Embedded robot controller, I/O interfacing, and PWM amplifiers
Lesson 4: Controller software and sensor inputs
Lesson 5: ADC and sensor-based controls
Lesson 6: Algorithms and planning strategies for specific tasks
Lesson 7: Kinematics, differential motion and navigation

As suggested, we would like to send a faculty member with the 4 students who can guide them during the stay as well as if you can accept him/her as an exchange faculty to teach in the SCMS for 2 weeks. Do you think it's possible?

At the same time, the cost of the program is 300 USD for each participant. It would be more possible to get students if you minimize the cost such as not more than 200 USD.

Looking forward to hearing from you.

- *With best regards*

Syed Raihan-UI-Islam

Senior Administrative Officer, International Affairs

Daffodil International University

102/1, Shukrabad, Dhanmondi, Dhaka-1207, Bangladesh.

Tel: +88 02 9138234 (Ext: 237) | Mob: +88-01811458865
 WhatsApp/Viber/Wechat: +88-01920012744



[Quoted text hidden]

Dr. Varun G Menon <varunmenon@scmsgroup.org> Wed, Dec 5, 2018 at 9:36 AM
 To: "International Affairs, DIU" <int@daffodilvarsity.edu.bd>
 Cc: Emran Hossain <emran@daffodilvarsity.edu.bd>, "International, DIU" <international@daffodilvarsity.edu.bd>, "Office of the International Affairs, DIU" <mobility@daffodilvarsity.edu.bd>, Scholarship News <scholarship@daffodilvarsity.edu.bd>, Pramod <pramod@scmsgroup.org>, Kazi Mesbah Ur Rahman <oia@daffodilvarsity.edu.bd>, "Dr. Praveensal C.J." <praveensal@scmsgroup.org>, Sunil Jacob <suniljacob@scmsgroup.org>, Gopakumar S <gopakumars@scmsgroup.org>

Dear Mr. Syed Raihan-UI-Islam,
 Thank you for the message. Will discuss with the Director and get back to you at the earliest.
 Thanks and Regards,
 Varun

Dr. Varun G Menon
 Associate Professor-Computer Science Engineering
 Corporate Relations and International Collaborations-in charge
 SCMS School of Engineering and Technology
 Karukutty, Ernakulam, Kerala, India - 683 582
 Office: +91-484-2450330 Mob: +91-8714504684
 Web: <http://www.scmsgroup.org>



SCMS
 GROUP OF EDUCATIONAL INSTITUTIONS

[Quoted text hidden]

International Affairs, DIU <int@daffodilvarsity.edu.bd> Tue, Dec 18, 2018 at 3:04 AM
 To: "Dr. Varun G Menon" <varunmenon@scmsgroup.org>
 Cc: Emran Hossain <emran@daffodilvarsity.edu.bd>, "International, DIU" <international@daffodilvarsity.edu.bd>, "Office of the International Affairs, DIU" <mobility@daffodilvarsity.edu.bd>, Scholarship News <scholarship@daffodilvarsity.edu.bd>, Pramod <pramod@scmsgroup.org>, Kazi Mesbah Ur Rahman <oia@daffodilvarsity.edu.bd>, "Dr. Praveensal C.J." <praveensal@scmsgroup.org>, Sunil Jacob <suniljacob@scmsgroup.org>, Gopakumar S <gopakumars@scmsgroup.org>

Dear Dr. Varun,
 How are you? Any update of the program if you discussed? Looking forward to hear from you.

- With best regards

Syed Raihan-UI-Islam
Senior Administrative Officer, International Affairs
Daffodil International University
 102/1, Shukrabad, Dhanmondi, Dhaka-1207, Bangladesh.
 Tel: +88 02 9138234 (Ext: 237) | Mob: +88-01811458865
 WhatsApp/Viber/Wechat: +88-01920012744

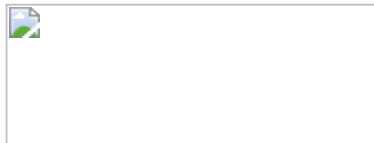

[Quoted text hidden]

Dr. Varun G Menon <varunmenon@scmsgroup.org> Thu, Jan 10, 2019 at 11:04 AM
 To: "International Affairs, DIU" <int@daffodilvarsity.edu.bd>

Cc: Emran Hossain <emran@daffodilvarsity.edu.bd>, "International, DIU" <international@daffodilvarsity.edu.bd>, "Office of the International Affairs, DIU" <mobility@daffodilvarsity.edu.bd>, Scholarship News <scholarship@daffodilvarsity.edu.bd>, Pramod <pramod@scmsgroup.org>, Kazi Mesbah Ur Rahman <oia@daffodilvarsity.edu.bd>, "Dr. Praveensal C.J." <praveensal@scmsgroup.org>, Sunil Jacob <suniljacob@scmsgroup.org>, Gopakumar S <gopakumars@scmsgroup.org>

Dear Mr. Syed Raihan-UI-Islam,

Thank you for the collaboration with SCMS.

The syllabus communicated by your Department looks fine. The Internship at SCMS Center for Robotics would mainly focus on implementation of projects based on the syllabus topics. As we have also planned a few advanced topics, It would be great to have students who have good understanding of the basics.

We would be happy to welcome one faculty form DIU along with the students for the program. The faculty could also share ideas with our students. We will take care of accommodation and food of the faculty.

We have already made the arrangements for the program this year with the cost of 300 USD. We will definitely look into your suggestions regarding the cost in the subsequent years.

The tentative date planned for the start of the program is 17th June 2019.

Looking forward to your reply,

Thank you

Dr. Varun

[Quoted text hidden]

International Affairs, DIU <int@daffodilvarsity.edu.bd>

Sun, Jan 13, 2019 at 6:35 PM

To: "Dr. Varun G Menon" <varunmenon@scmsgroup.org>

Cc: Emran Hossain <emran@daffodilvarsity.edu.bd>, "International, DIU" <international@daffodilvarsity.edu.bd>, "Office of the International Affairs, DIU" <mobility@daffodilvarsity.edu.bd>, Scholarship News <scholarship@daffodilvarsity.edu.bd>, Pramod <pramod@scmsgroup.org>, Kazi Mesbah Ur Rahman <oia@daffodilvarsity.edu.bd>, "Dr. Praveensal C.J." <praveensal@scmsgroup.org>, Sunil Jacob <suniljacob@scmsgroup.org>, Gopakumar S <gopakumars@scmsgroup.org>

Dear Dr. Varun,

Good to hear from you. Thanks for coming back with udapted information. We are passing the information to our relevant department with your mentioned date plan. Hope the course plan will be redesigned as per department's suggestion that i sent to you.

We hope to send a group of students along with an Excahnge Faculty Member.

- *With best regards*

Syed Raihan-UI-Islam

Senior Administrative Officer, International Affairs

Daffodil International University

102/1, Shukrabad, Dhanmondi, Dhaka-1207, Bangladesh.

Tel: **+88 02 9138234 (Ext: 237)** | Mob: **+88-01811458865**

WhatsApp/Viber/Wechat: **+88-01920012744**

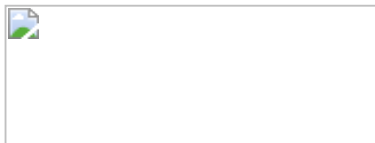

[Quoted text hidden]

Dr. Varun G Menon <varunmenon@scmsgroup.org>

Thu, Apr 25, 2019 at 8:59 PM

To: "International Affairs, DIU" <int@daffodilvarsity.edu.bd>

Cc: Emran Hossain <emran@daffodilvarsity.edu.bd>, "International, DIU" <international@daffodilvarsity.edu.bd>, "Office of the International Affairs, DIU" <mobility@daffodilvarsity.edu.bd>, Scholarship News <scholarship@daffodilvarsity.edu.bd>, Pramod <pramod@scmsgroup.org>, Kazi Mesbah Ur Rahman <oia@daffodilvarsity.edu.bd>, "Dr. Praveensal C.J." <praveensal@scmsgroup.org>, Sunil Jacob <suniljacob@scmsgroup.org>, Gopakumar S <gopakumars@scmsgroup.org>, Vinoj Pg <vinojpg@gmail.com>, "Sreeja M." <m.sreeja79@gmail.com>, Asha Jacob <ashajacob@scmsgroup.org>

Dear Syed Raihan-UI-Islam,

Thank you for sharing the details thorough Skype video call and confirming your participation in the Internship program to be conducted at Center for Robotics, SCMS School of Engineering and Technology. I am summarizing the discussion we had through the Skype call,

- Four students and a faculty member would be reaching Cochin by June 16th 2019.

- The Internship program led by Dr. Sunil Jacob, Director Center for Robotics would start at SCMS School of Engineering and Technology on June 17th Monday.
- Faculty member from DIU would be engaging few sessions for faculty and students at SCMS Group of Educational Institutions
- The course would start from an Intermediate level as requested by the DIU team.
- SCMS would be providing the invitation letters to the students and faculty for visa application.
- Four students would be paying an amount of 300 USD each towards accommodation, food and local transportation that would be arranged by SCMS.
- Further details to be discussed in the next Skype Video call/meeting.

I look forward to the full name (Name as in passport) of the students and faculty for providing the Invitation letters. Also please attach the passport copies of all the members.

Thank you,

Dr. Varun G Menon
Associate Professor-Computer Science Engineering
Corporate Relations and International Collaborations-in charge
ACM Distinguished Speaker
Guest Editor-Journal of Supercomputing, Springer
SCMS School of Engineering and Technology
SCMS Group of Educational Institutions
Karukutty, Ernakulam, Kerala, India - 683 576
Office: +91-484-2450330 Mob: +91-8714504684
Web: <http://www.scmsgroup.org>



SCMS
GROUP OF EDUCATIONAL INSTITUTIONS

[Quoted text hidden]

--

Thanks and Regards,

International Affairs, DIU <int@daffodilvarsity.edu.bd>

Thu, May 2, 2019 at 1:01 PM

To: "Dr. Varun G Menon" <varunmenon@scmsgroup.org>

Cc: Emran Hossain <emran@daffodilvarsity.edu.bd>, "International, DIU" <international@daffodilvarsity.edu.bd>, "Office of the International Affairs, DIU" <mobility@daffodilvarsity.edu.bd>, Scholarship News <scholarship@daffodilvarsity.edu.bd>, Pramod <pramod@scmsgroup.org>, Kazi Mesbah Ur Rahman <oia@daffodilvarsity.edu.bd>, "Dr. Praveensal C.J."

<praveensal@scmsgroup.org>, Sunil Jacob <suniljacob@scmsgroup.org>, Gopakumar S <gopakumars@scmsgroup.org>, Vinoj Pg <vinojpg@gmail.com>, "Sreeja M." <m.sreeja79@gmail.com>, Asha Jacob <ashajacob@scmsgroup.org>

Dear Dr. Varun,

Greetings!

Please find the attached list of students and faculty member who will be joining in your university for the **Robotics Camp from 17 June 2019**.

I also attached the CV of **Khandker M Qaiduzzaman Lecturer | Department of Software Engineering** who will be the team leader and also possibly take some classes as per your arrangement.

You can issue the letter of invitation for them according to their information

We can set up next skype call during the 2nd week of May since we are now having semester break and all the students are out of campus.

I will be waiting to hear from you.

- *With best regards*

Syed Raihan-UI-Islam

Assistant Director, International Affairs

Daffodil International University

Address: Daffodil Tower-4, 102/1 Shukrabad, Dhanmondi, Dhaka-1207, Bangladesh.

Tel: **+88 02 9138234 (Ext: 237)** | Mob: **+88-01811458865**

WhatsApp/Viber/Wechat/Telegram: **+88-01920012744**



2 attachments

 **Deligate Details.docx**
15K

 **CV-Khandker-M-Qaiduzzaman.pdf**
168K

Dr. Varun G Menon <varunmenon@scmsgroup.org> Tue, May 14, 2019 at 3:03 PM
 To: "International Affairs, DIU" <int@daffodilvarsity.edu.bd>
 Cc: Emran Hossain <emran@daffodilvarsity.edu.bd>, "International, DIU" <international@daffodilvarsity.edu.bd>, "Office of the International Affairs, DIU" <mobility@daffodilvarsity.edu.bd>, Scholarship News <scholarship@daffodilvarsity.edu.bd>, Pramod <pramod@scmsgroup.org>, Kazi Mesbah Ur Rahman <oia@daffodilvarsity.edu.bd>, "Dr. Praveensal C.J." <praveensal@scmsgroup.org>, Sunil Jacob <suniljacob@scmsgroup.org>, Gopakumar S <gopakumars@scmsgroup.org>, Vinoj Pg <vinojpg@gmail.com>, "Sreeja M." <m.sreeja79@gmail.com>

Dear Mr Syed,
 Please see the attached **Invitation Letters** for the students and faculty from DIU visiting SCMS in June.
 Dr. Sunil Jacob, Director Center for Robotics is available for Skype call this week. Please let me know a suitable time.
 Let me know any further help or information required.

Thank you,
 Varun
 [Quoted text hidden]

--
 Thanks and Regards,

Dr. Varun G Menon
Associate Professor-Computer Science Engineering
Corporate Relations and International Collaborations-in charge
ACM Distinguished Speaker
Guest Editor-Journal of Supercomputing, Springer
SCMS School of Engineering and Technology
SCMS Group of Educational Institutions
Karukutty, Ernakulam, Kerala, India - 683 576
Office: +91-484-2450330 Mob: +91-8714504684
Web: <http://www.scmsgroup.org>



2 attachments

 **DIU Faculty_Invitation.pdf**
260K

 **DIU Students_Invitation.pdf**
1007K

International Affairs, DIU <int@daffodilvarsity.edu.bd> Tue, May 14, 2019 at 4:48 PM
 To: "Dr. Varun G Menon" <varunmenon@scmsgroup.org>
 Cc: Emran Hossain <emran@daffodilvarsity.edu.bd>, "International, DIU" <international@daffodilvarsity.edu.bd>, "Office of the International Affairs, DIU" <mobility@daffodilvarsity.edu.bd>, Scholarship News <scholarship@daffodilvarsity.edu.bd>, Pramod <pramod@scmsgroup.org>, Kazi Mesbah Ur Rahman <oia@daffodilvarsity.edu.bd>, "Dr. Praveensal C.J." <praveensal@scmsgroup.org>, Sunil Jacob <suniljacob@scmsgroup.org>, Gopakumar S <gopakumars@scmsgroup.org>, Vinoj Pg <vinojpg@gmail.com>, "Sreeja M." <m.sreeja79@gmail.com>

Dr. Varun

Thanks for sending the letters. We will set the meetings soon.

Let me discuss with students and the faculty member.

[Quoted text hidden]

--

[Quoted text hidden]

"Office of the International Affairs, DIU" <mobility@daffodilvarsity.edu.bd>

Mon, Jun 10, 2019 at 12:54 PM

To: "Dr. Varun G Menon" <varunmenon@scmsgroup.org>

Cc: Syed Raihan-UI-Islam <int@daffodilvarsity.edu.bd>

Dear Dr. Varun,

Greetings of the day!

Hopefully, you are doing well. Our four students deposit their registration fee for the program. May I request you to issue an invoice for registration fee payment. Please include the following accounts/bank information in the invoice that we can transfer the registration fee.

1. Account Name
2. Account No
3. Bank Name
4. Branch Name
5. Bank Address
6. SWIFT Code
7. Bank Tel. No
8. Total Amount

We are looking forward to hearing from you.

Best regards,

Md. Nazmul Islam

Assistant Administrative Officer

Office of the International Affairs

Daffodil International University (DIU)

102/1 Sukrabad, Mirpur Road,

Dhanmondi, Dhaka-1207, Bangladesh.

📞 +8801847334763

☎ +88 02 9138234 (Ext-233)

✉ mobility@daffodilvarsity.edu.bd

🌐 www.daffodilvarsity.edu.bd

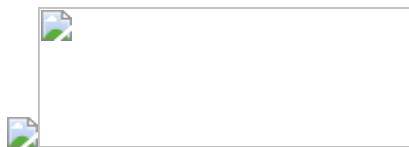

[Quoted text hidden]

Dr. Varun G Menon <varunmenon@scmsgroup.org>

Mon, Jun 10, 2019 at 6:44 PM

To: "Office of the International Affairs, DIU" <mobility@daffodilvarsity.edu.bd>

Dear Sir,

Thank you for the email. We will generate the Invoice and share the details with you soon.

Regards,

Dr. Varun

[Quoted text hidden]

Dr. Varun G Menon <varunmenon@scmsgroup.org>

Tue, Jun 11, 2019 at 10:21 AM

To: Pramod <pramod@scmsgroup.org>

Dear Sir,

Please see the below email requesting Invoice and payment details for the Internship program by Daffodil University office.

Thank you,

Varun

[Quoted text hidden]



Varun Menon G <varunmenon@scmsgroup.org>

Internship Opportunities for Daffodil International University

5 messages

Md. Ziaul Haque Zim 181-15-11333 <ziaul15-11333@diu.edu.bd>
To: "varunmenon@scmsgroup.org" <varunmenon@scmsgroup.org>

Mon, Mar 4, 2019 at 7:23 PM

My name is Md Ziaul Haque Zim, and I'm a undergraduate student in B.Sc. in Computer Science & Engineering at the Daffodil International University, Bangladesh. This semester I'm in One semester exchange program in Computer Science & Technology at Saint Petersburg Electrotechnical University – ETU "LETI", Saint Petersburg, Russia.

I'm very much interested in Mechatronics, AI, Robotics, Automation. I'm looking for a internship and Centre for Robotics, SCMS School of Engineering and Technology caught my eye as a place where I could really make a difference.

I heard about Centre for Robotics, SCMS School of Engineering and Technology a few days ago as a institution that's researching and backing new, innovative institution in multiple fields in Robotics. As a Computer Science & Engineering student, Automation, AI, Machine Learning, Image Processing has always been a passion of mine. In the past, I've big experience at **Daffodil International University Robotics Club** that worked with startups looking to find developing and contribute my knowledge in robotics in their projects. For the past one years, I've taken some classes in "Micro Controller & Robotic Remote Controlled Car" that stress the importance of research, logistics, and debate before making a major decision in Robotics projects. Because of my background and natural interest in Automation, Robotics & AI, I'm writing to see if "*Centre for Robotics, SCMS School of Engineering and Technology*" is hiring for student internships in the research and technological development sector. I'm confident that I could perform with excellence as a Centre for Robotics intern.

I attached some document (such as Passport scan copy, student ID card, DIU & ETU "LETI" exchange program letter). Centre for Robotics, SCMS School of Engineering and Technology is at the top of my list of internships and I am very interested in hearing more about it. Thank you very much for your time, and I look forward to talking with you.

Best,

Md. Ziaul Haque Zim
Studies B.Sc. in Computer Science And Engineering
Daffodil International University, Bangladesh.

3 attachments

ID.jpg
2259K



Passport.jpg
1240K



Letter of Admission Mr Zim.jpg
545K

Dr. Varun G Menon <varunmenon@scmsgroup.org>
To: "Md. Ziaul Haque Zim 181-15-11333" <ziaul15-1133@diu.edu.bd>

Sun, Mar 10, 2019 at 7:39 PM

Dear Md Ziaul Haque Zim

Thank you for the email and the interest in the Internship program. I am currently traveling and back at college on Wednesday. I will reply in detail then. Our program starts by June 17th. We can also plan a Skype session between you and the Director of Robotics Center. Will take forward your request on Wednesday.

Thank you
Varun

[Quoted text hidden]

Md. Ziaul Haque Zim 181-15-11333 <ziaul15-1133@diu.edu.bd>
To: "Dr. Varun G Menon" <varunmenon@scmsgroup.org>

Mon, Mar 18, 2019 at 11:38 PM

Dear Sir,

I'm very glad and pleasure to received your reply. I'm replying lately because recently I contact Saint Petersburg Electrotechnical University - ETU "LETI" authority after received your email, for knowing the official ending date of this program and they replied it was **30th June, 2019**.

If any other internship opportunity offering from *Centre for Robotics, SCMS School of Engineering and Technology* after **June 30, 2019**. I'm ready to join. And I already have 1 year long INDIAN Tourist VISA, so after June 30, 2019 any time I have no

problem to arrive in INDIA. And I'm looking for the next procedure from you.

Best regards,

Md. Ziaul Haque Zim
Studies B.Sc. in Computer Science And Engineering
Daffodil International University, Dhaka, Bangladesh.

Dr. Varun G Menon <varunmenon@scmsgroup.org>
To: "Md. Ziaul Haque Zim 181-15-11333" <ziaul15-1133@diu.edu.bd>

Tue, Mar 19, 2019 at 12:07 PM

Dear Md. Ziaul Haque Zim,
Thank you for the message. I will definitely let you know about opportunities at Center for Robotics in future.
Have a great time in Russia.

Varun

[Quoted text hidden]

--

Thanks and Regards,

Dr. Varun G Menon
Associate Professor, Computer Science Engineering
ACM Distinguished Speaker
Corporate Relations and International Collaborations-in charge
SCMS School of Engineering and Technology
SCMS Group of Educational Institutions
Karukutty, Ernakulam, Kerala, India - 683 582
Office: +91-484-2450330 Mob: +91-8714504684
Web: <http://www.scmsgroup.org>



Md. Ziaul Haque Zim 181-15-11333 <ziaul15-1133@diu.edu.bd>
To: "Dr. Varun G Menon" <varunmenon@scmsgroup.org>

Sun, Apr 14, 2019 at 12:28 AM

Dear Sir,
I'm writing you very late. But I need to know more about this Internship. Is this internship is free of cost? Or I need to pay for something?
Please reply me with details. Because I found some friend who is interested for this.

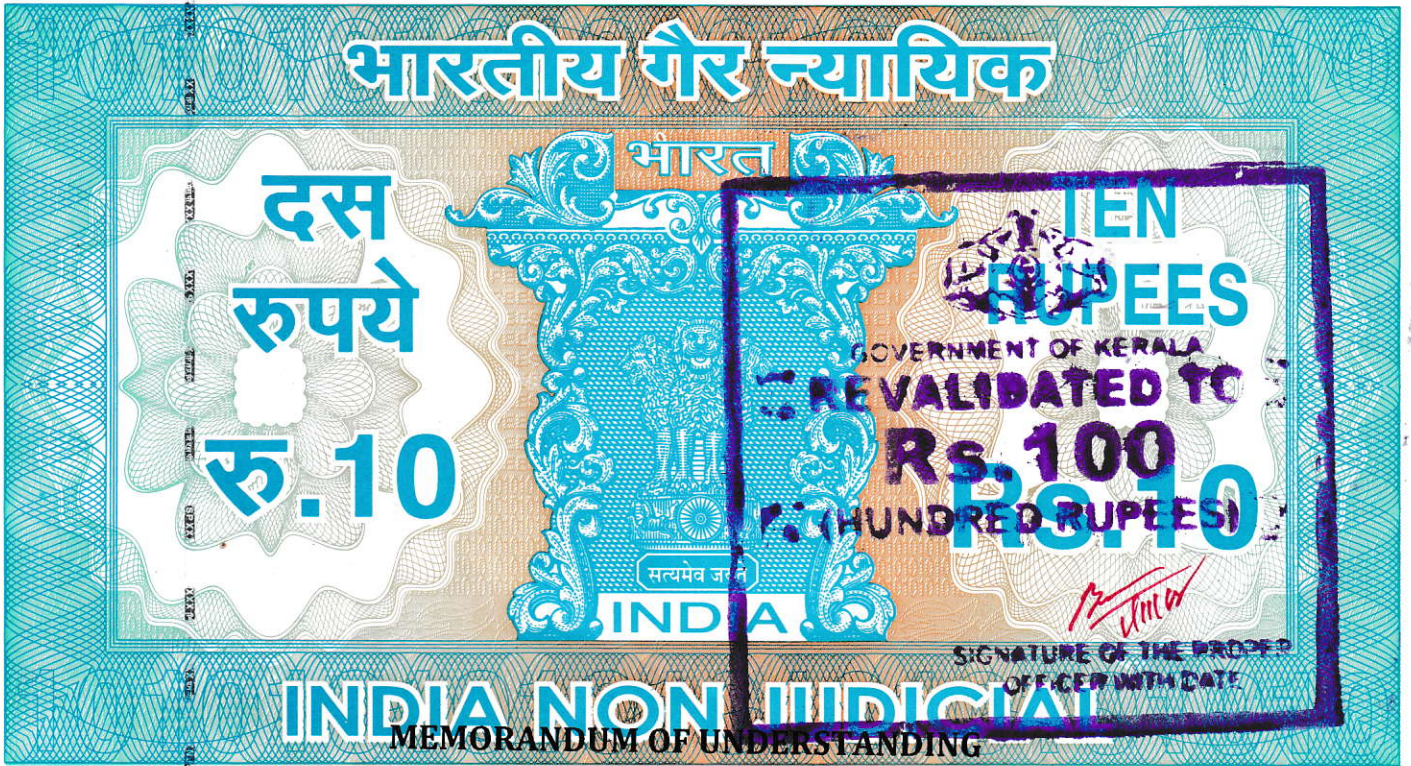

കേരളം കേരल KERALA

25AA 736508

This Memorandum of Understanding ("MoU") is executed on this **20th day of December** in the year **Two Thousand and Eighteen** at Kochi by and between;

Kochi Metro Rail Limited, a joint venture company of Government of India and Government of Kerala, entrusted for setting up a world-class metro rail system in Kochi, having its Corporate Office at 8th Floor, Revenue Tower, Park Avenue, Kochi-682011, Kerala, India, represented by its Managing Director, Sh. Mohammed Hanish, I.A.S, (hereinafter referred to as "KMRL", which the term shall unless otherwise repugnant to the context shall mean and include all its successors and permitted assigns) on the FIRST PART;

 Managing Director
 Kochi Metro Rail Ltd
 Kochi-682 011



43762 NO. 7-11-2018 Date

Link.....To.....

Kochi Metro Rail Ltd

 LISSY SEBASTIAN
 CJM Court Vendor, Ekm

Memorandum of Understanding between KMRL & SCMS-WI

[Signature]



കേരളം KERALA

25AA 736509

The **SCMS Water Institute**, a Centre of Excellence on Water, represented by SCMS Group of Educational Institutions, having its registered office at Prathap Nagar, Muttom, Kochi, Kerala, and represented by its Vice Chairman, Sh. Pramod P Thevannoor, (hereinafter referred to as "SCMS", which the term shall unless otherwise repugnant to the context shall mean and include all its successors and permitted assigns) on the SECOND PART.

KMRL and SCMS are hereinafter collectively referred to as "Parties" and may also be referred to individually as "Party".

1. The Mission of KMRL is to provide a reliable, safe, efficient, viable and customer friendly mass rapid transit systems for the Greater Kochi Region, which is environmentally and financially sustainable. KMRL also aims at enhancing the quality of life of the people in the region. KMRL wants to implement rainwater-harvesting systems at the metro stations, depot, as well as

43763

NO. 2-11-2018

Link.....

Kochi Metro Rail Ltd

LISSY SEBASTIAN
CJM Court Vendor, Ekm

Managing Director
Kochi Metro Rail Ltd
Kochi-682 011



Memorandum of Understanding between KMRL & SCMS-WI

viaducts so as to reduce its dependency on treated water from public distribution network. KMRL looks to carry out a pre-feasibility study on the implementation of rain water harvesting systems at its facilities.

2. SCMS is committed to promote water audit, conservation and management. Over the last few years, SCMS has been providing technical support to Local Self Governments (LSGs) in Kerala in addressing their challenges in managing the water resources.

3. The purpose of this MoU is to establish the basis and structure of a collaboration between the above-mentioned parties to integrate best practices in rainwater harvesting at metro stations and viaducts to ensure water sustainability of Kochi Metro.

CLAUSE 1: OBJECTIVES

1.1 To have an integrated, systematic effort to address effective utilization of rainwater collected over metro stations, depot and viaducts.

1.2 To reduce the dependency on public water distribution system and to contribute excess water resources to overcome the water scarcity in the city.

1.3 To have a comprehensive water management policy for the operations of Kochi Metro.



Memorandum of Understanding between KMRL & SCMS-WI



Managing Director
Kochi Metro Rail Ltd
Kochi-682 031

1.4 As a part of achieving the above objectives, SCMS would assist KRML in these specific tasks:

- a. Assess the water use patterns at metro stations.
- b. Provide technical assistance to KMRL in conducting water audit at metro stations.
- c. Quantify the harvestable rainwater and assess feasibility of harvesting at selected locations.
- d. Provide technical assistance for KMRL and associated stakeholders covering all aspects of rainwater harvesting.
- e. Provide technical advisory support to KMRL for the development of a Comprehensive Water Management Policy.

1.5 By mutual agreement between the Parties mentioned above, additional, sustainable water initiatives may be developed under the auspices of this MOU.

CLAUSE 2: EXECUTION

2.1 The KMRL will ensure and coordinate the participation of the staff and other resources. KMRL will nominate a senior officer for the initiatives, who will have the requisite skills, experience and authority to keep the initiative moving forward in a timely manner and who will have direct access to the key decision makers.



Managing Director
Kochi Metro Rail Ltd
Kochi-682 011

2.2 The Managing Director / or any of the competent officers of KMRL, who has the decision-making authority under this collaboration, commits to meeting with the representatives of SCMS at major decision points, to discuss options and/or communicate his/her decision to SCMS. Such meetings shall be held at Kochi. No expenditure will be reimbursed to SCMS for attending such meetings.

CLAUSE 3: RESPONSIBILITIES OF THE PARTIES

3.1 This MoU does not involve the transfer of financial resources between the Parties or generate any obligations to either Party to compensate each other in case the actions and programs agreed upon do not take place. Each Party is responsible for its own expenses.

3.2 KMRL and SCMS agree to jointly and individually seek financial resources for the projects under this collaboration from public and private sources. The obligations with personal and/or third parties, assumed by either of the Parties, will not lead to obligations to the other Party and are of sole responsibility of the Party that has assumed them. KMRL agrees to provide SCMS with requisite data, maps, drawings, information, reports, etc. that are necessary for the execution of the objectives as listed in this MoU.



Managing Director
Kochi Metro Rail Ltd
Kochi-682 011 5

- 3.3 KMRL and SCMS agree that all the data provided and study reports created as part of this collaboration can be made available in the general public domain, unless it is specifically agreed mutually that a data or portions of a report need to be held confidential, in the best interest of the human settlements in cities.

CLAUSE 4: DURATION

- 4.1 This Memorandum of Understanding has the duration of three years from the date of its execution and can be extended further based on mutual agreement by a written agreement by all Parties.

CLAUSE 5: ALTERATIONS AND ADDITIONS

- 5.1 Any alteration of the conditions and clauses established in this Memorandum of Understanding must be agreed and signed by all Parties to this MoU.
- 5.2 Any issue not defined in the MoU should be agreed formally between the Parties, signed by the Parties, and added to this MoU.



Managing Director
Kochi Metro Rail Ltd
Kochi-682 011

CLAUSE 6: RESCISSION

6.1 The Memorandum of Understanding can be cancelled by either Party, formally, with a minimum of thirty days' notice, through a written letter or due to a change in law that will not permit its execution.

IN WITNESSTH WHEREOF the parties hereto have set their hands and seal on the day and year first mentioned herein above.

For Kochi Metro Rail Ltd.
A.P.M.Mohammed Hanish
Managing Director,
Kochi Metro Rail Ltd.

For SCMS Water Institute
Pramod P Thevannoor
Vice Chairman, SCMS
Group of Educational
Institutions



Witness 1

Name: *Dr. Sunny George*
Director, SCMS WATER
INSTITUTE
Signature:

Witness 2

Name: *G.P.HARI*
Additional GM (Urban Transport)
Kochi Metro Rail Ltd
Signature:
20/12/2018



SCMS Water Institute signing MoU with Kochi Metro Rail Corporation (KMRL), Kochi for conducting a feasibility study of the potential of rain water harvesting at the stations of Kochi Metro, viaducts and depot.



**Agreement of Cooperation
between
SCMS Group of Educational Institutions
and
Hochschule Furtwangen / Furtwangen University of Applied Sciences (HFU)**

In order to extend the effective and mutually beneficial cooperation and develop academic and cultural exchange in education, research and other areas, SCMS Group of Educational Institutions and Hochschule Furtwangen hereby agree to cooperate toward the internationalization of higher education.

The areas of cooperation will include any program offered at either university which is felt to promote the above-mentioned goals. However, any specific program shall be subject to mutual consent, availability of funds and the approval of both universities. Such programs may include:

- a) exchange of faculty members
- b) exchange of students
- c) exchange of publications
- d) joint research projects
- e) joint conferences
- f) joint teaching projects
- g) joint cultural programs.

The terms of such mutual assistance and cooperation shall be discussed and agreed upon in writing by the responsible authority of each university prior to the initiation of any particular program or activity.

This agreement shall take effect upon approval by both parties and shall remain in effect for an initial period of five years. Thereafter it shall automatically be renewed annually. However, either university may terminate the agreement in writing at least ten months prior to the beginning of an academic year.

Cochin, India
4.09.2015

Prof. Pramod P. Thevannoor
Vice Chairman
SCMS Group of Educational Institutions
Cochin, Kerala, INDIA.



22. SEP. 2015

Prof. Dr. Rolf Schofer
President
Hochschule Furtwangen / Furtwangen University
of Applied Sciences

MoU Signing Ceremony - Furtwangen University, Germany & SCMS

SCMS School of Engineering and Technology renewed MoU with Furtwangen University, Germany. SCMS is having an MoU with University of Furtwangen in order to have students & faculty exchange, joint research, institutional strengthening, etc. This MoU is valid for five years. The new MoU between SCMS and Furtwangen University, Germany were exchanged between P.C Pillai, Group Director, SCMS Group and Prof. Dr. Ulrich Mescheder, Director of Institute for Applied Research, Furtwangen University, Germany; during the inaugural session of International seminar on education, opportunities & life in Europe on August 25th, 2017 at SSET campus.



MoU between SCMS and Furtwangen University, Germany were exchanged between P.C Pillai, Group Director, SCMS Group and Prof. Dr. Ulrich Mescheder, Director of Institute for Applied Research, Furtwangen University, Germany

International Seminar on Education, Opportunities & Life in Europe

Seminar was conducted on August 25th, 2017 at SSET in two sessions.

In the first session Prof. M Madhavan, Principal, SSET gave the welcome address and Dr. Sunny George, Director, SCMS Water Institute presented the objective of this seminar. Presidential Address gave by P.C Pillai, Group Director SCMS Group. SCMS is having an MoU with University of Furtwangen in order to have students & faculty exchange, joint research, institutional strengthening, etc. After Felicitation by Dr. Praveensal C J, Vice-Principal, SSET, the MoU between SSET and Furtwangen University, Germany were exchanged between P.C Pillai and Prof. Dr. Ulrich Mescheder, Director of Institute for Applied Research, Furtwangen University, Germany. Prof Mescheder is an internationally renowned scientist on sensor as well as nanotechnology at Furtwangen University. It's one of the most prestigious universities in Europe. Dr George Thomas is a former Indian student who did his M.Tech and PhD from University of Konstanz, Germany and now working as scientist in Switzerland. Both of them spoke on career journey linking Indo- German- Swiss opportunities in education, research, entrepreneurship etc. It was an invaluable opportunity for students from all disciplines of engineering who are interested to do their M.Tech or Ph D programme in Europe. Dr. Anitha G Pillai, Dean-Academics & Head Department of Civil Engineering gave vote of thanks to the gathering.

In the afternoon session, Prof. Dr. Ulrich Mescheder addressed M.Tech environmental engineering students on latest advancements in sensor as well as nanotechnology in environmental engineering research and business. He gave a brief on Furtwangen University's role in the development of sensor technology and algorithms necessary for the sensor systems, as well as the interface of the sensor technology to the higher level information system and a briefing on general aspects of microtechnology.



Speech by Prof. Dr. Ulrich Mescheder, Director of Institute for Applied Research, Furtwangen University, Germany



Prof. Dr. Ulrich Mescheder, Director of Institute for Applied Research, Furtwangen University, Germany addressing M.Tech students of SSET



Prof. Dr. Ulrich Mescheder, Director of Institute for Applied Research, Furtwangen University, Germany addressing B.Tech students of SSET

Approved by

HOD



Cooperation Agreement

Preamble:

Both the institutions **SCMS group** and **SEWERIN** have interests on special fields of water and wastewater technology and it was found out that there could be synergies in working together. The goal of this cooperation between the both parties is to support the training and joint handling of projects in the field of leak detection technologies.

1. This cooperation agreement is established between the following two institutions:

- **SCMS Group of Educational Institutions**

SCMS Campus

Prathap Nagar, Muttom

Cochin - 683 106, Kerala, India

Represented by Prof. Pramod P. Thevannoor

Vice Chairman

and

HERMANN SEWERIN GMBH

Robert-Bosch-Straße 3

33334 Gütersloh

Represented by Dr. Swen Sewerin

CEO

2. **SCMS Group** as a private educational institution offers undergraduate and graduate programs in management, business and technology and has R&D activities on various fields. The **SCMS Water Institute (SWI)** is a division of **SCMS Group of Educational Institutions** with the following objectives:

- Developing water and wastewater technologies including reuse of water and recycling of valuable components
- Fine-tuning of given technologies for local conditions
- Framing water policies
- Performing environmental impact assessments and water audits
- Offering water related capacity building on all levels



SEWERIN
Hermann Sewerin GmbH
Robert-Bosch-Str. 3 - 33334 Gütersloh
Tel.: 0 52 41 / 9 34 - 0
Fax: 0 52 41 / 93 44 44

SEWERIN

SEWERIN is a private, independent and owner-operated company. Our focus lies on developing, producing and distributing worldwide water and gas leak detection instruments.

Our own research, development and production department secures our independence and international pole-position in the field of leak detection technology.

These both institutions are interested in a close cooperation to develop and to adapt approved technologies to the specific tropical conditions. The focus lies on water and pipe location equipment, leak detection in particular.

For the specific project applications separate *Letters of Intend* will be agreed on.

3. The role of the two partners is as follows:

SCMS:

- identification of fields for research and application
- basic investigation for the preparation of research and application projects
- providing of qualified project support by staff or students of SCMS Group

SEWERIN:

- supply of the necessary technical equipment
- providing of qualified project support
- support and training of staff or students

4. Results, which are worked out in common projects will be published or used together, but only upon mutual agreement.
5. All technical information as well as information about projects, which are exchanged in the frame of this cooperation, will be handled confidentially. All rights will stay with the institution which has delivered this information.
6. The cooperation can be terminated from each side to the end of a year by written notice three months in advance.

Cochin, 4.09.2015

(signature/ stamp)

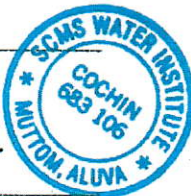

Gütersloh, 10.09.2015

(signature/ stamp)

SEWERIN

Hermann Sewerin GmbH
Robert-Bosch-Str. 3 - 33334 Gütersloh
Tel.: 0 52 41 / 9 34 - 0
Fax: 0 52 41 / 93 44 44

MoU Signing Ceremony - SEWERIN GmbH

An internationally successful and technologically innovative German company which is a world leader in pipe location and water leak detection has MoU with SCMS Group for academic and technological collaboration. Sewerin has donated both leak detection and pipe locating instruments worth several lakhs for SCMS Water Institute. Students and in- service engineers from government are being trained by SCMS Water Institute using these equipment's from SEWERIN GmbH.

- **“Water Pipe Leak Detection and Pipe Tracing”**; by Sewerin GmbH, Germany, September 26, 2016

On September 26, 2016 a workshop on leak detection and pipe locating were conducted at SSET. Dr. Syed Ibrahim, Honorary Consul of Germany in Kerala & Director, Goethe-Zentrum, Trivandrum inaugurated the workshop conducted at SCMS School of Engineering and Technology, Karukutty, Ernakulam and experts from Sewerin were resource persons. These workshops were an example of an academia-industry joint research initiative, where the participants from various sections of the society like water authority, irrigation department, consultants, technicians, NGOs and students got hands on training in the usage and application of leak detection and pipe locating technologies.



Mr. Lutz Höernschemeyer, Manager, Sewerin from Germany conducting training program on leak detection & pipe locating in association with SWI at the ‘Joint leak detection training facility’ at SSET campus on September 26, 2016

- **“Water pipe leak detection & tracing training”, October 18, 2015**

SCMS Water Institute at SCMS School of Engineering & Technology, Karukutty, Ernakulam enjoys a MoU with SEWERIN GmbH for the training and skill development in the usage of leak detection sensors for monitoring water distribution networks. SCMS School of Engineering and Technology, Karukutty, Ernakulam in collaboration with SEWERIN, GmbH, Germany, a pioneer in leak detection has conducted a training workshop on October 18, 2015 at our main campus to train M.Tech Environmental Engineering students of SSET and donated the state of the art technology sensors to SCMS Water Institute for the mentioned purpose. Hon: Vice Chancellor of KTU was kind enough to accept these equipments from SEWERIN GmbH on behalf of SCMS Water Institute.



Mr. Lutz Höernschemeyer, Manager, Sewerin from Germany giving a demonstration for students of SSET to locate water pipe on October 18, 2015

Approved by

Handwritten signature of the HOD.

HOD

Cooperation Agreement

Präambel:

The Institutions **SCMS Group** and **LimCo International GmbH (Limco)** had several meetings in the frame of Indian-German cooperation activities. During the discussions about various technological aspects of water and wastewater it was found out that there could be best synergies in working together. The goal of this cooperation between the both parties is to develop and to apply together best economic and effective solutions in the named fields in research and practical applications, under involvement of staff and students from both sides and from further partners.

- This cooperation agreement is established between the following two institutions:
- **SCMS – School of Engineering and Technology SSET**
SCMS Campus
Prathap Nagar, Muttom
Cochin 683 106, Kerala, India
represented by Prof. Pramod P. Thevanoor
Vice Chairman.
- **LimCo International GmbH**
Blarerstr. 56, 78462 Konstanz, Germany
represented by the Managing Director Dr. Almut Gerhardt
- **SCMS** group as a private educational institution offers undergraduate and post graduate programs in management, business and technology and has R&D activities on various fields. SCMS Water Institute is an activity of SCMS Group of Educational Institutions at SSET with the following objectives:
 - developing water and wastewater technologies including reuse of water and recycling of valuable components
 - finetuning of given technologies for local conditions
 - framing water policies
 - performing environmental impact assessments and water audits
 - offering water related capacity building on all levels

LimCo International GmbH is specialized in the research, development, consulting, education and engineering in the water sector. We especially develop innovative technologies for continuous monitoring of water quality for drinking, surface, re-use and wastewater as well as



LimCo International GmbH
Technologiezentrum Konstanz
Blarerstr. 56
D-78462 Konstanz

seawater and aqua/maricultures, such as the Multispecies Freshwater Biomonitor, the LimCo Biosensor System and the new biofilm sensor. We are partner in several national and international applied research projects in aquatic and soil ecotoxicology, we have lecturing contracts with the HTWG Konstanz and we exchange and co-supervise students at different career levels. We also perform consultancies in stream and land fill assessments.

- These both institutions are interested in a close cooperation to develop and apply new technologies and to adapt approved technologies to the specific tropical conditions. The focus is water and wastewater treatment, re-use of water from rain water, aquacultures, etc.

For specific project applications separate Letters of Intend (LoI) will be agreed on.

Following projects could be of interest among others:

- Adapt the Multispecies Freshwater Biomonitor (MFB) to Indian conditions to monitor WWTP effluents, rivers, reservoirs for drinking water, etc.
- Adapt the biofilm sensor to monitor water quality in drinking water tanks and swimming pools
A goal of the cooperation is to apply the research results on a technical level in practical application in larger scale, e.g. in a pilot WWTP plant of SSET.
- The role of the two partners is as follows:

SCMS:

- identification of fields for research and application
- basic investigation for the preparation of research projects (elaborating of funding sources and proposal writing)
- providing of qualified project support by staff or students of SSET
- performing local research work by applying this technology in India.

LimCo:

- Technology transfer such as demonstration, workshops, lectures
- Technology loan for pilot plants and applications
- Co-supervision of research work and joint publications
- Student exchange and support (both ways)



LimCo International GmbH
Technologiezentrum Konstanz
Blarerstr. 56
D-78462 Konstanz

- Results, which are worked out in common research projects will be published or used together.
- All technical information resp. technology as well as information about projects, which are exchanged in the frame of this cooperation, will be handled confidentially. All rights will stay with the institution which has delivered this information resp. technology.
- The cooperation can be terminated from each side to the end of a year by written notice three months in advance.
- The following had been agreed by both partners based on the points mentioned above:

1. SCMS Group shall help LimCo as a Knowledge Partner.
2. Student to come in Spring for 1 month to learn the equipment (covered by project of Prof. Fritsch (BWS), Limco is looking for a room as soon as this is approved).
3. Student works in India on application of the biomonitor in India with a native species (3 months): financed by the locally by SSET.
4. Writing joint research papers for scientific journals.
5. Application for further funding for research in this field in Indian conditions.
6. Joint research, workshops and demonstration of equipment & technology in India.

Cochin,

27/01/2015



(signature/ stamp)

Konstanz,

13.01.2015



(signature/ stamp)



LimCo International GmbH
Technologiezentrum Konstanz
Blarerstr. 56
D-78462 Konstanz

LimCo International GmbH, Germany

LimCo GmbH, an expert in biomonitoring, has given their Automated Multi species Biomonitoring Device costing Rs 8 lakhs to SCMS Water Institute for optimizing and fine tuning the instrument to Indian conditions.



Merin Mathew (2013 admission) student from the first batch of M. tech Environmental Engineering) was selected to undergo advanced training at International GmbH, Konstanz, Germany for a period of five weeks in May 2015. Limco International GmbH is an internationally reputed German company, a consultant in Limcology (science of fresh water). Merin Mathew got training in their worldwide unique IP-protected LimCo BioSensor system (LBS) based on the established Multispecies Freshwater Biomonitor (MFB). After the training, the biosensing equipment was brought to SCMS Water Institute for conducting studies in India and Merin Methew is continuing the project at SCMS Water Institute.



• Linda Joy (2014 admission) of M. tech Environmental Engineering undergone a one month industrial training at Limco International GmbH, Germany from 22nd October to 22nd November 2015.

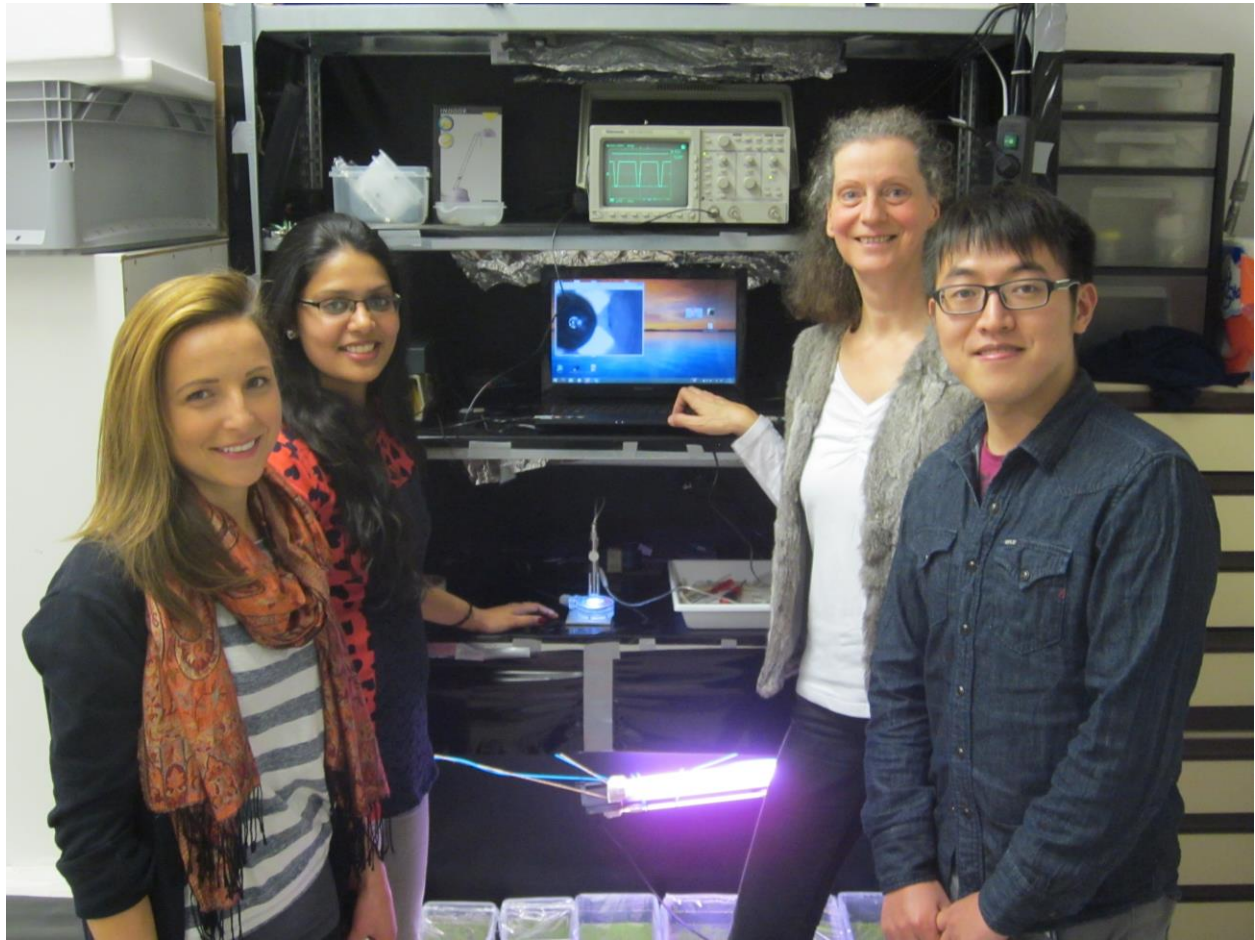

Approved by

HOD

Agreement on Partnership and Co-operation

Between

SCMS-COCHIN

SCMS group of Educational Institutions

Cochin/India

And

Hochschule Ravensburg-Weingarten (HRW)

Germany

SCMS-Cochin of the SCMS group of Educational Institutions Cochin/India (in the following denoted as SCMS-Cochin) and **Hochschule Ravensburg-Weingarten/Germany** (in the following denoted as HRW) agree to the following terms:

1. DEFINITIONS

In this agreement, unless otherwise stipulated, HOME institution shall mean the institution at which faculty and students intend to teach/graduate. HOST institution shall mean the Institution that has agreed to receive faculty and staff from the HOME institution.

Unless otherwise stipulated, the academic year of SCMS-Cochin means three terms spread between July and April. Likewise, regarding HRW, the academic year means two semesters October to February and March to September.

2. PURPOSE

The objective of this agreement is to establish special relations and cooperation between the two institutions in order to enrich the understanding of the culture of the two countries concerned. This agreement is to make possible and to institute the exchange of undergraduate and graduate students as well as faculty between the institutions on a continuing basis.

The purpose of exchange of faculty members is to promote collaborative research, internationalise the curricula and to further mutual understanding.

The purpose of the student exchange will be to enable students to take units (classes) but not to study for a full period of the degree at the HOST institution. Units passed at the HOST institution will normally be accepted for credit towards the degree of the candidate's HOME institution for which he or she is enrolled. It will be the responsibility of each participant in

the Students Exchange Program to obtain official approval from his or her own institution for units taken at the HOST institution.

3. NUMBERS

Faculty Exchange:

Subject to the teaching schedule, SCMS-Cochin will send up to 2 (two) faculty members in each academic year and HRW will send up to 2 (two) faculty members during the duration of the agreement unless amended by mutual agreement. The faculty on exchange will have to essentially teach at least one full course, meeting the total number of contact hours as prescribed by the HOST institution. Both the institutions agree that they will make every effort to schedule the class sessions in such a way as to minimize the stay of the faculty on exchange at their campus. However, each institution will ensure that such rescheduling of class sessions will in no way lead to compressing the course or reduce the minimum prescribed contact hours.

In principle, the exchange of faculty will occur on a one-for-one basis. The number may vary in a given year, but over a fixed period of five years, the total number of faculty participants shall be balanced.

Student exchange:

Subject to the availability of suitable candidates SCMS Cochin will send up to 5 (five) students in each academic year and HRW will send up to 5 (five) students in each academic year during the duration of the agreement unless amended by mutual agreement. The period of study will be for one or two trimesters at SCMS Cochin or one or two semesters at HRW. The duration of a period of exchange would normally be up to one year.

In principle the exchange of students will occur on a one-for-one basis. The number may vary in a given year, but over a fixed period of five years, the total number of student participating shall be balanced.

Organizing International Study weeks

Both the institutions agree to accept the terms from each other on international study weeks for a maximum duration of two weeks.

4. SELECTION OF STUDENTS

The HOME institution will screen applications from its student body for exchange. The program is available for graduate students who have completed at least one third of the requirements of the graduate program.

Each institution will send the other, completed applications for their students sixteen weeks before the beginning of the entry semester or term. The exchange students may apply to any academic program offered at the respective HOST institution.

The HOST institution will reserve the right to make final judgement of the eligibility of each student nominated. The HOST Institution also retains the right to assess a student candidate's language proficiency (if applicable) or previous academic background before admitting that student to any one course. This may have the net effect of restricting the range of courses at the HOST institution, open to the visiting guest student. All exchange students shall abide by the rules and regulations of the HOST institution.

5. RESPONSIBILITIES OF THE TWO INSTITUTIONS

SCMS Cochin and HRW agree to accept exchange students from each other and enroll them as full-time "not-for-degree" students for the regular semesters of the academic year. Each institution will provide the necessary counseling and assistance to the exchange students.

6. FINANCIAL RESPONSIBILITIES OF THE TWO INSTITUTIONS

Student Exchange:

Each HRW-student studying at SCMS-Cochin will be provided, without further cost, with:

- Tuition
- Orientation
- Reports and statement of results (transcript)

Each SCMS Cochin student studying at HRW will be provided, without further cost, with:

- Tuition
- Orientation
- Reports and statement of results (transcript)

Faculty Exchange:

The financial details of faculty procedures will be as detailed below:

- SCMS Cochin agrees to meet the cost of economy class ticket by the shortest route to Cochin, India for the exchange faculty from HRW
- SCMS Cochin will meet the cost of local transport of the visiting faculty from HRW during their stay at Cochin
- SCMS Cochin will provide accommodation and food to visiting faculty from HRW at its guest house located on campus during their stay at Cochin. However, if the visiting faculty decides to make any alternative arrangement for accommodation elsewhere it will be at their cost.

- SCMS Cochin and HRW will, in addition to all the above and as it is the practice in similar exchange arrangements with other international institutions, pay each visiting faculty for every full credit course taught by them amounts mutually agreed by the two institutions

The participating institutions shall not be responsible for any private arrangements made by participating staff members concerning exchange of accommodation and vehicles. It is not anticipated that spouses or dependents will accompany a faculty member. Where such arrangement is planned it is understood that additional expenses are the responsibility of the faculty member.

7. FINANCIAL RESPONSIBILITY OF EXCHANGE STUDENTS

Each student participating in the exchange program shall meet the full costs related to:

- Travel to and from India and Germany and vice versa as the case may be
- Books and stationery
- Travel documents and visa
- Living and subsistence expenses as an exchange student
- Application or related fees for participating in the program as may be charged by the HOME institution
- The cost of health and/or medical insurance at the HOST institution and the HOST country

The HOME institution shall satisfy itself that the nominated student has met the financial conditions stipulated before granting acceptance.

The HOST institution shall render all assistance to the student in seeking accommodation within reasonable distance of the campus

Where a student spends more than one semester or term at a HOST institution by enrolling in parts of two academic years, the student must have the funds to cover living and subsistence costs over the summer and/or winter break.

8. SCMS WATER INSTITUTE

As a project of collaborative research the

SCMS Water Institute (SWI)

has been founded in February 2012 at SCMS Cochin, at the beginning under the name "Centre of Sustainable Water Technology and Management"

The objectives of SWI are the following:

- developing water and wastewater technologies including reuse of water and recycling of valuable components

- finetuning given technologies for local conditions
- framing water policies
- performing environmental impact assessments and water audits
- offering water related capacity building on all levels
- taking up demand driven initiatives on a consultancy basis

Students and staff of both institutions being the main actors to meet these objectives, these activities of the SWI are included into the agreement.

The details of the structure and organization of SWI, both on side of SCMS group and on side of HRW, have been developed in the last years and will be improved further.

The fact of this cooperation between the two institutions can be used by both institutions in their external communication.

For student or staff exchange within common projects of the two institutions under the SWI scheme, each institution will cover the costs for travelling and the expenses of living of its own members. There will be no financial transfer between the institutions for establishing the necessary infrastructure of the institute.

9. TERMS OF AGREEMENT AND AMENDMENT

This agreement shall remain in force for a period of **5 (five) years from 10th December 2015** with the understanding that it may be revised, terminated or suspended pending availability of places by either party giving six months written notice to the other party and in a manner that the student(s) participating in the exchange scheme is in no way adversely affected.

Either party may terminate the Agreement at any time during the term by the provision of six months written notice to the other party.

10. GENERAL

SCMS Cochin and HRW shall undertake all the measures as are seen reasonable to give maximum effect to this exchange program. Such actions will include the exchange of academic handbooks, newsletters and promotion material.

SCMS Cochin and HRW will be responsible for regular review of the exchange program on a yearly basis. The review is essential to make appropriate and mutually agreed modifications as may be required, and to identify new opportunities of cooperation in scholarship and research.

11. SIGNATURES

This agreement constitutes the entire agreement between the parties. There are no understandings, agreements, or representations, oral or written, not specified herein regarding this agreement. No amendments, consent, or waiver of terms of this agreement shall bind either party unless writing and signed by all parties. Any such amendment, consent, or waiver shall be effective only in the specific instance and for the specific purpose given. SCMS Cochin and HRW by signature of their authorized representatives below, acknowledge having read and understood the agreement and agree to be bound by these terms and conditions.

For and on behalf of SCMS Cochin

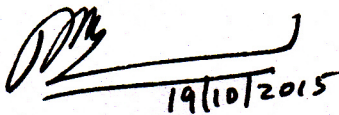

Prof. Pramod Thevanoor
Vice-Chairman

Date:

Witness

For and on behalf of Hochschule Ravensburg-Weingarten



Prof. Dr. Michael Pfeffer
Vice Rector Research and International Relations

Witness: Prof. Dr. Johannes Fritsch
International Coordinator
Energy and Environmental Engineering

UNIVERSITY OF APPLIED SCIENCES RAVENSBURG-Weingarten, Germany

SCMS Water Institute (SWI) at SSET has Memorandum of Understanding with University of Applied Sciences, Ravensburg-Weingarten in order to develop SWI into a Centre for Excellence in water within the coming few years. A project named “Establishment of a Centre of Competence on Water and Waste Water” has been sanctioned by Württemberg-Stiftung, Stuttgart, Germany for this purpose.

This project includes:

- Joint research on different mechanisms on membrane separation named Low Energy Electro dialysis, Forward Osmosis, Effluent Water Treatment etc.
- Faculty and Student Exchange
- Strengthening of the M. Tech Environmental engineering course at SSET.
- Institutional strengthening
- Automation in water treatment.

SCMS Group has various collaborations with this university since 2010. SCMS Water Institute itself is fruit of this collaboration initiative. Two visionaries namely, Prof Dr Johannes Fritch of University of applied sciences, Ravensberg- Weingarten, Germany and late Prof Dr. Pradeep P Thevannor, then Vice Chairman of SCMS Group were the key persons initiated this collaborative mission. As per the MoU between these two institutions, joint research, student and faculty exchange, institutional strengthening etc are the main aims of this technical collaboration.



Prof Pramod P Thevanoor, Vice Chairman of SCMS Group, in the presence of Honourable Mr Jorn Rhode, Consul General of Germany in Bengaluru, and Shri. K M Chandrasekhar IAS (Retd), Vice Chairman, Kerala State Planning Board signing the MoU with Prof. Dr. Michael Pfeffer, Vice Rector, University of Applied Science, Ravensburg-Weingarten on October 19, 2015

Aleena James, Ashly Mary Mammen and Neenu Georgina Johnson (2013 admission) of M. Tech Environmental Engineering at SSET had been at University of Applied Sciences Ravensburg-Weingarten, Germany, as part of the student exchange programme between University of Applied Science Ravensburg-Weingarten and SSET during November – December 2014.



Approved by

HOD



Cooperation Agreement

Preamble:

Both the institutions SCMS Group and NIVUS have interests on special fields of water and wastewater technology and it was found out that there could be synergies in working together. The goal of this cooperation between the both parties is to support the training and joint handling of projects in the field of flood prevention, new technologies and protection of the environment. We are focussing especially on flow measurement technologies.

1. This cooperation agreement is established between the following two institutions:

- **SCMS School of Engineering and Technology (SSET)**

SCMS Campus
Prathap Nagar, Muttom
Cochin 683 106, Kerala, India
Represented by Mr. Pramod P. Thevannoor
Vice Chairman

and

- **NIVUS GmbH**

Im Täle 2
75031 Eppingen
Represented by Mr. Schmalz and Mrs. Vondenhof

2. **SCMS** Group as a private educational institution offers undergraduate and graduate programs in management, business and technology and has R&D activities on various fields. SCMS Water Institute is a division of SCMS Group of Educational Institutions at SSET with the following objectives:

- Developing water and wastewater technologies including reuse of water and recycling of valuable components
- Fine-tuning of given technologies for local conditions
- Framing water policies
- Performing environmental impact assessments and water audits
- Offering water related capacity building on all levels



NIVUS GmbH
Im Täle 2 • D-75031 Eppingen
Tel. +49 (0) 7262 9191-0
Fax +49 (0) 7262 9191-999
Internet: www.nivus.de

NIVUS

NIVUS is a private, independent and owner-operated company.

Our focus lies on measurement technology for water and wastewater using the ultrasonic technology.

Our own investigation, development and production department secures our independence and international pole-position in the field of flow measurement technology.

These both institutions are interested in a close cooperation to develop and apply new technologies and to adapt approved technologies to the specific tropical conditions. The focus is water and wastewater technology, flow measurement in particular.

For the specific project applications separate *Letters of Intend* will be agreed on.

3. The role of the two partners is as follows:

SCMS:

- identification of fields for research and application
- basic investigation for the preparation of research and application projects
- providing of qualified project support by staff or students of SSET

NIVUS:

- supply of the necessary technical equipment
- providing of qualified project support
- support and training of staff or students

4. Results, which are worked out in common projects will be published or used together, but only upon mutual agreement.
5. All technical information as well as information about projects, which are exchanged in the frame of this cooperation, will be handled confidentially. All rights will stay with the institution which has delivered this information.
6. The cooperation can be terminated from each side to the end of a year by written notice three months in advance.

Cochin, 4.09.2015

(signature/ stamp)

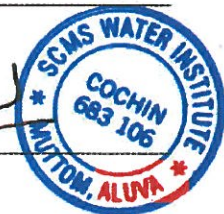

Eppingen, 04/09/2015

(signature/ stamp)



Im Tale 2 • D-75031 Eppingen
Tel. +49 (0)7262 9191-0
Fax +49 (0)7262 9191-999
Internet: www.nivus.de

MoU Signing Ceremony - NIVUS GmbH

NIVUS is another company having remarkable association with SCMS Group. NIVUS which is an internationally reputed company in ultrasonic flow measurements, has provided equipment's worth several lakhs for SCMS Water Institute for technical teaching, demonstration and training purposes.



SWI team and SSET students conducting field studies and projects using the instruments sponsored by NIVUS GmbH, Germany to SWI

SCMS brings sensor to rate water loss in transit

SMITHA N. | DC
KOCHI, FEB. 21

Transmission loss of water is a term Kerala, facing an acute drought, will have to grapple with now, and the SCMS Water Institute at SCMS School of Engineering, Karutty, has come up with an ultrasonic sensor which can help measure it.

The sensor can automatically assess water velocity, water level, depth of water body and quantity of water discharged and help quantify the water loss.

"The real-time measurements along with satellite remote sensing data of the area will help estimate the demand, supply and deficit," said Dr. Sunny George, director of SCMS Water Institute. "It will be helpful in preparing and implementing an effective water management system. It will also improve water use efficiency in the canal network."

A recent survey conducted by the students of the institute on various stretches of Chalakudy river diversion canal network revealed that a huge



SCMS students testing the ultrasonic sensor.

quantity of water is lost mainly through the unlined parts of the canal and unauthorised pumping to nearby areas. The total discharge at Ezhattumugham, where the right bank canal starts, was measured to be 4,700 litres per second while the measurements at Edalakkad junction, about 5.5 km downstream, showed a discharge of 2,000 litres per second. This means about 2,000 litres of water is lost during the transit.

Though the irrigation department has no actual data on the quantity of water transmission loss, an earlier study conducted by the Kerala Agricultural University in Palakkad had found that though targeted efficiency of canal irrigation system is more than 80 per cent, actual efficiency was only 40 to 60 per cent. As per the Directorate of Economics and Statistics, the net irrigated area in the state as on March 31, 2015 is 4.14 lakh hectares.



Two German technologists who are international experts on Environmental Hydraulics provided training for MTech Environmental Engineering students of SSET on 07-02-2018

Approved by

HOD

See discussions, stats, and author profiles for this publication at: <https://www.researchgate.net/publication/340156661>

Controllability studies on fish-shaped unmanned under water vehicle undergoing manoeuvring motions

Chapter · August 2019

DOI: 10.1201/9780367810085-34

CITATIONS

0

READS

1,270

6 authors, including:



Ak Ranjith

SCMS Group of Educational Institutions

6 PUBLICATIONS 9 CITATIONS

[SEE PROFILE](#)



Sheeja Janardhanan

Indian Maritime University

68 PUBLICATIONS 86 CITATIONS

[SEE PROFILE](#)



Vidya Chandran

SCMS School of Engineering and Technology, Karukutty

24 PUBLICATIONS 32 CITATIONS

[SEE PROFILE](#)



Noel Gomez

SCMS Group of Educational Institutions

4 PUBLICATIONS 2 CITATIONS

[SEE PROFILE](#)

Controllability studies on fish-shaped unmanned under water vehicle undergoing manoeuvring motions

A.K. Ranjith, S. Janardhanan, V. Chandran & N.J. Gomez

Department of Mechanical Engineering, SCMS School of Engineering and Technology, Ernakulam, India

G. Ilieva

Department of Ship Building, Technical University of Varna, Bulgaria

J. Sygal

Department of Ocean Engineering, Indian Institute of Technology Madras, India

ABSTRACT: Bio-inspired propulsion systems have many advantages over the conventional ones. They are found to be noiseless and eco-friendly. Most of the aquatic locomotion makes use of oscillations, paddling and water-jet for producing net thrust on the body. In this paper a box-fish shaped unmanned underwater vehicle (UUV) has been considered for studying its controllability. A RANS based CFD method has been implemented for simulating manoeuvring motions in heave and pitch to obtain the forces and moments during such motions.

1 INTRODUCTION

Bio-inspired propulsion is a much researched field these days. The fact that, the noise and vibrations produced during the operation of conventional propellers have adversely affected the bio-diversity of oceans, has made bio-inspired propulsion more enticing to mankind. Getting rid of the conventional rotary components of a propulsion system completely is also not practical. Ocean transport do contribute to a mammoth scale of world's economy. Hence there should be a balance between bio-inspired flapping foil as well as the conventional propulsion systems so that we do not tamper much with the ecological systems and at the same time do contribute to the economy.

Nature is known as the master engineer. The efficiency of propulsion of some aquatic animals have struck us in awe and the values of their efficiency have far outperformed those of man-made vehicles. Now it is time to have a few such vehicles operating in the oceans. There have been many studies in the past decades concentrating on the flapping foil mechanisms on ocean vehicles: both surface and sub-sea. Most of them focused on the determination of propulsive efficiency while others on the controllability.

1.1 Understanding the locomotion of fish

The locomotion of the fish is indeed complex yet efficient. Various fins involved in the locomotion or swimming are shown in Figure 1.

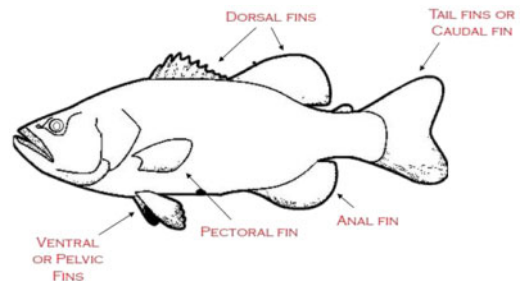

Figure 1. Various fins on the body of a fish.

Fishes swim using all the fins. The locomotion a fish swimming with tail fin or the caudal fin and the trunk is broadly classified into anguilliform, subcarangiform, carangiform, thunniform and ostraciiform (Figure 2). From anguilliform to ostraciiform the locomotion gets simplified with the deteriorating involvement of the trunk as the undulations of the entire trunk reduces to mere oscillations of the tail during swimming. Locomotion of the fish with varying involvement of the trunk and tail is shown in Figure 3.

In ostraciiform models, the undulation is confined mostly to the caudal fin without moving the body. The thrust for this model is generated with a lift-based method, allowing cruising speeds to be maintained for long periods. This form is considered to be the simplest of all for carrying out mathematical studies. A UUV with hull form geometrically similar to

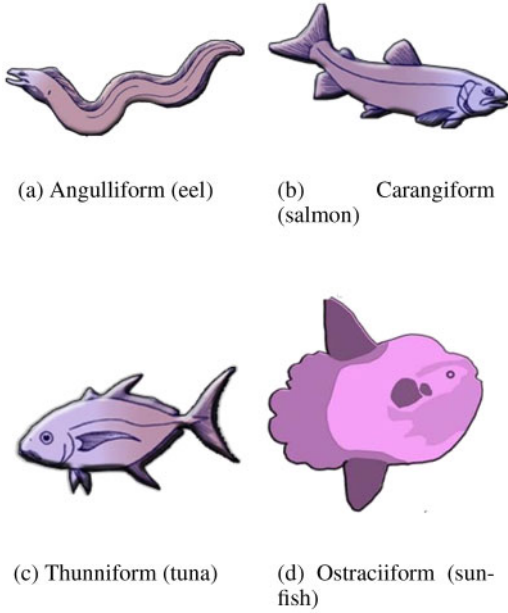

Figure 2. Fish with different types of tail locomotion.

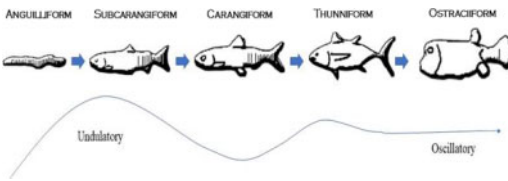

Figure 3. Undulatory motion of the entire trunk to oscillatory motion of the tail.

that of a box-fish, a typical ostraciiform model undergoing manoeuvring motions in heave and pitch, has been analysed for controllability in the present study. UUVs also known as underwater drones are vehicles with no humans onboard during the course of their mission. There are basically two types of UUVs-autonomous underwater vehicle (AUV) and remotely operated vehicle (ROV). AUVs are more or less like robots not entailing human intervention throughout their mission while ROVs are remotely operated from a ground station.

In the case of present work, the vehicle's hull form is more important than its mode of operation. Guidance and control are very important aspects in the design of marine vehicles no matter whether they are surface or underwater vehicles. A motion planning and control system was developed for autonomous surface vehicles by Hinostroza, Guedes Soares, & Xu 2018. This work aims at achieving the first step in controllability predictions-determination of forces and moments during manoeuvring motions. A linear mathematical model combined with a RANS based CFD method has been used for obtaining the thrust generated during the

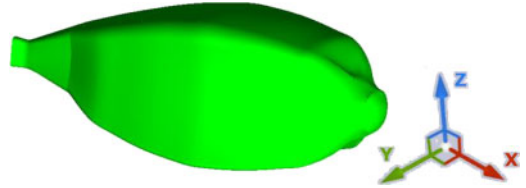

Figure 4. Three dimensional representation of the box-fish shaped UUV.

Table 1. Principal particulars of the UUV.

Dimension	Size (metres)
Length (L)	1.3
Breadth (B)	0.5
Depth (D)	0.5

oscillatory motions of the tail with ANSYS FLUENT as the solver. The forces and moments acting on the hull form in both static and dynamic manoeuvres have been estimated. This paper is an initial step towards the controllability and stability prediction of fish-shaped UUVs which could be used in search and rescue as well as surveillance missions. Hence it is imperative to predict the trajectory of such vessels well in advance through controllability studies of its hull form.

It is quite evident that the ostraciiform type of locomotion is the simplest mode of locomotion. A design based on this type of locomotion will be obviously the most feasible for a UUV. The studies on ostraciiform type of locomotion was reported by Blake 1977. The study made some interesting observations. For slow progression, the caudal fin inclination with the longitudinal axis of the body is about 3 to 6 deg while for fast progression, the angle is 35 deg. 3-D manoeuvring studies were carried out on a fish-like robot by Wu, Yu, Su, & Tan 2014. The robotic fish here was fabricated using multi-link joints to obtain the agility during swimming and hence better manoeuvrability. The present study considers the controllability aspects of a box-fish by numerically simulating the manoeuvring motions.

Not much work has been reported on the determination of hydrodynamic derivatives of the body form for assessing the vessels controllability. This paper presents a method for numerically evaluating the hydrodynamic forces and moments-an initial step towards the estimation of hydrodynamic derivatives and thereby the controllability of a box-fish shaped underwater vehicle.

2 UUV GEOMETRY

A box fish in its three dimensional configuration is shown in Figure 4. The principal particulars of the fish are given in Table 1.

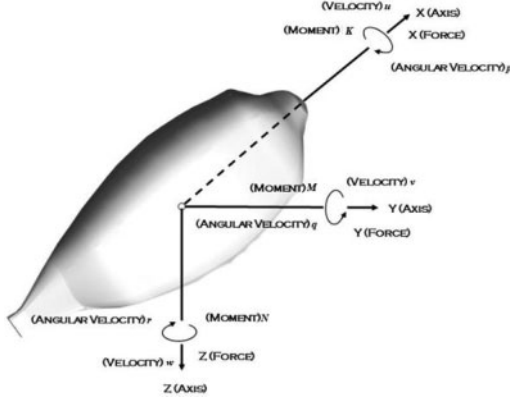

Figure 5. Co-ordinate system used in the study.

3 MATHEMATICAL MODEL

The Cartesian co-ordinate system of the UUV is shown in Figure 5. The conventional North-East-Down (NED) system is followed here.

A linear mathematical model describing the manoeuvring motions of the UUV is represented by Equations (1) through (6)

$$X = X_{\dot{u}}\dot{u} + X_{|u|}u^2 + X_w w + X_q q + X_{\delta}\delta + X_T \quad (1)$$

$$Y = Y_{\dot{v}}\dot{v} + Y_v v + Y_p p + Y_r r + Y_{\delta}\delta \quad (2)$$

$$Z = Z_{\dot{w}}\dot{w} + Z_w w + Z_u u + Z_q q + Z_{\delta}\delta \quad (3)$$

$$K = K_{\dot{p}}\dot{p} + K_p p + K_v v + K_r r + K_{\delta}\delta \quad (4)$$

$$M = M_{\dot{q}}\dot{q} + M_q q + M_w w + M_u u + M_{\delta}\delta \quad (5)$$

$$N = N_{\dot{r}}\dot{r} + N_r r + N_v v + N_p p + N_{\delta}\delta \quad (6)$$

where subscript T represents thrust and δ , the rudder angle.

4 NUMERICAL EVALUATION OF CONTROLLABILITY IN VERTICAL PLANE

4.1 Numerical modelling and meshing

For studying the hydrodynamic forces and moments on the UUV during manoeuvring motion there are two basic methods, viz. numerical and experimental. While experimental methods involve prohibitively expensive and rare facilities, numerical methods offer the ease of bringing tedious tasks to desks. However numerical methods have not yet become self sufficient to completely replace experiments. They definitely offer promising inputs to the conceptual design. In this paper an attempt has been made to simulate the manoeuvring motions in the vertical plane of the UUV's motions.

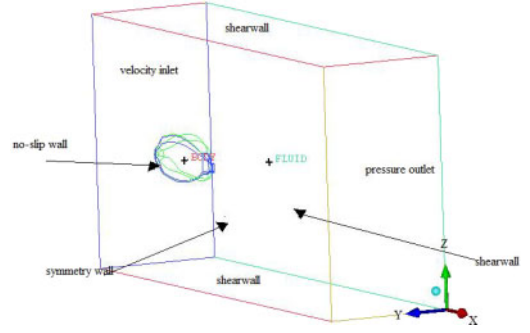

Figure 6. Computational domain with its boundaries.

Geometric modelling and meshing has been carried out using the commercial package ANSYS ICEM CFD. Figure 6 shows the computational domain. Its extends are $2.0L \leq x \leq 5.0L$, $2.0L \leq y \leq 2.0L$ and $0 \leq z \leq 2.0L$.

An unstructured meshing strategy is employed here. The minimum cell size has been calculated following the method described by Chandran, Janardhanan, Menon, et al. 2018.

Boundary layer thickness and the near wall element size have been calculated from boundary layer theory. The thickness of laminar sub-layer is obtained from Equation (7) (Schlichting & Gersten 2016).

$$\delta' = \frac{11.6v}{V^*} \quad (7)$$

where V^* is the frictional velocity given by Equation (8)

$$V^* = \sqrt{\frac{\tau_0}{\rho}} \quad (8)$$

and τ_0 , the wall shear stress, is obtained as in Equation (9).

$$\tau_0 = \frac{0.664}{\sqrt{Re_L}} \cdot \frac{\rho V^2}{2} \quad (9)$$

where, V is the flow velocity and Re_L the length based Reynolds number.

The mesh generated in the computational domain is shown in Figure 7(a). The magnified view around the fish body is shown in figure 7(b).

A velocity corresponding to $Re = 0.5 \times 10^6$ is imposed on the velocity inlet. The outlet is considered to be a pressure outlet. Half-fish model is used with the plane holding mid x-y plane as a symmetry wall. Non-slip boundary condition is assigned to the UUV body and slip walls to the far-field.

4.2 Steady-state predictions

Steady simulations are carried out with $k - \omega$ SST two equation model. PISO scheme is used for pressure velocity coupling. The convergence criteria is set

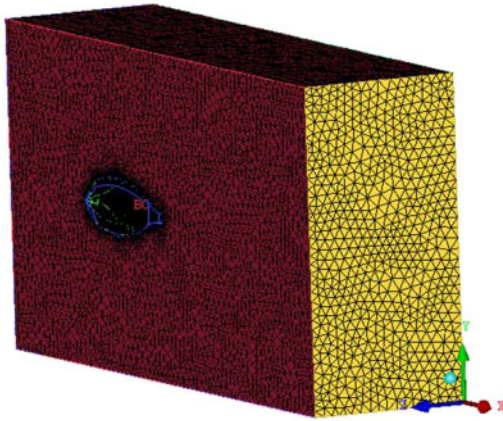

(a) Mesh in the domain

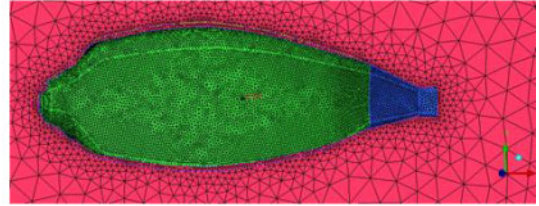

(b) Magnified view around the UUV body

Figure 7. Unstructured mesh for computation.

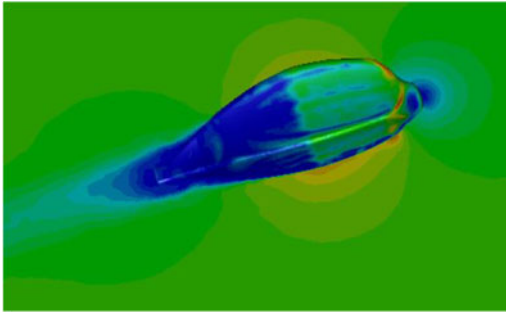

Figure 8. Dynamic pressure contours on the half-UUV.

to 10^{-7} . The simulations have been carried out using ANSYS FLUENT version 18.1. Dynamic pressure contours on the half-fish model is shown in Figure 8.

4.3 Static manoeuvre simulations

As the 3D simulations were time consuming, for faster predictions, a cut section of the UUV in the 2D plane is used for further analysis. The coefficients of drag (C_D) and lift (C_L) obtained from 3D simulations discussed in the previous section have been used as the reference. The challenge in 2D CFD simulations to yield results close to 3D simulations lies in defining the reference value in the third dimension. As this value remains constant and doesn't consider the variation in the geometry of the model, 2D computations provide only approximate values. Nevertheless, these computations provide enough insights into the flow physics as well as hydrodynamic forces and moments in the initial phase of any design.

Simulations have been carried out by varying the drift angle (β) from 0 to 12.5 deg in the vertical plane. The velocity contours around the UUV obtained from

the simulation are presented in Figure 9. Figures from 9 (a) to 9 (f) represents different contours for various drift angles.

4.4 Propulsion tests

Propulsion tests have been carried out on a 2D model through prescribed rigid body motions on the tail using the displacement function given by Equation 10

$$\phi = -\phi_a \sin(\omega t) \quad (10)$$

through the user defined functions (UDF) module of the solver.

Here ϕ is the sinusoidal tail oscillation about y-axis, ϕ_a the amplitude of motion taken here as 12.5 deg, ω is the angular frequency, 0.5 rad/s and t , the instantaneous time. The wake oscillations indicating the effective production of thrust is depicted in Figure 10.

4.5 Dynamic manoeuvre simulations

Hydrodynamic forces and moments are predicted here by simulating the manoeuvring motions in heave and pitch. Roll motions are not considered.

The sinusoidal motions in heave and pitch have been brought in using UDF module of the solver. The displacement functions in pitch and heave are as given by Equations 10 and 11 respectively.

$$z = z_a \sin(\omega t) \quad (11)$$

Here z_a is taken as $D/4$. Simulations have also been carried out imposing combined heave and pitch on the UUV body. Contours of total pressure around the UUV body in heave, pitch and combined motions are shown in Figures 11, 12 and 13 respectively.

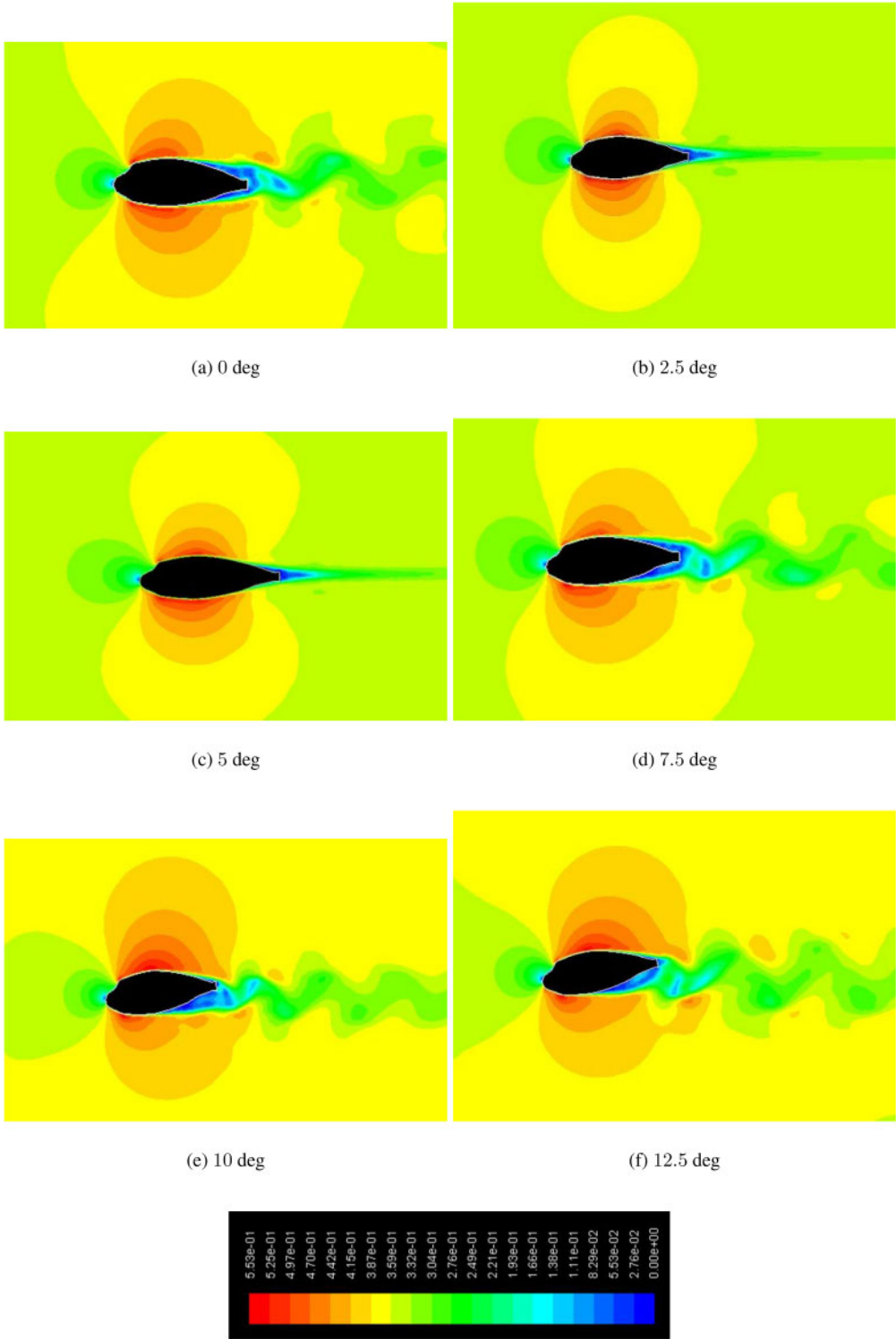

Figure 9. Velocity contours around the UUV at various angles of attack.

5 RESULTS AND DISCUSSIONS

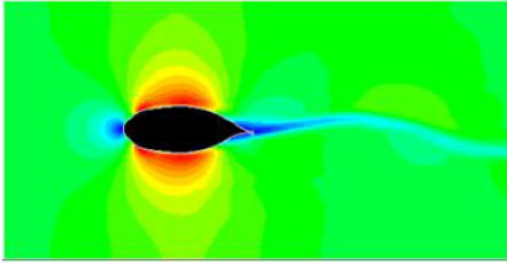

Figure 10. Wake oscillations due to tail motions.

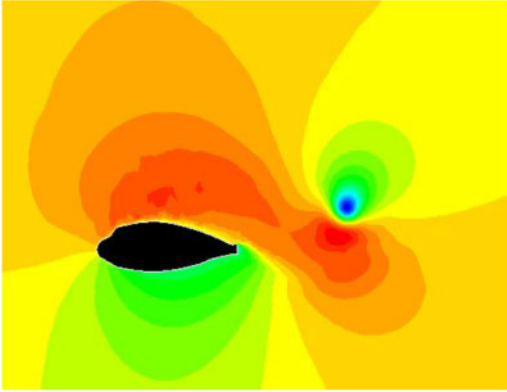

Figure 11. Total pressure contours in heave.

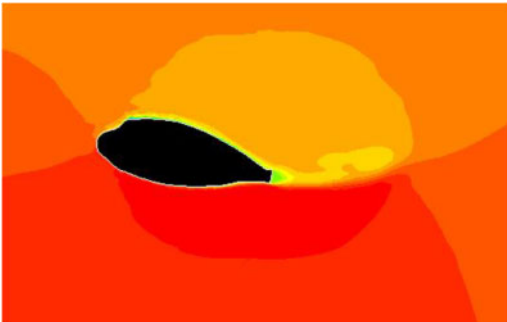

Figure 12. Total pressure contours in pitch.

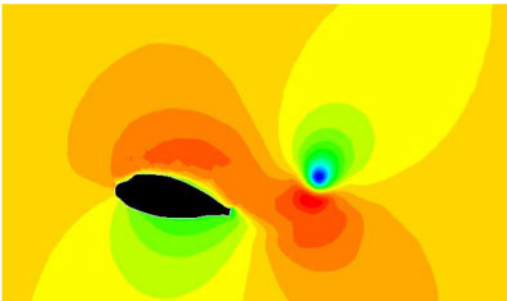

Figure 13. Total pressure contours in combined mode.

In the present work manoeuvre motion simulations have been carried out on an ostraciiform locomotion inspired box-fish shaped UUV. At the outset, steady state simulations were carried out on a half model of the UUV for $Re = 0.5 \times 10^6$. The simulation yielded the value of drag coefficient, C_D as 0.019 and lift coefficient, C_L as 0.0684. The 2D simulations with an approximation of the third side yielded $C_D = 0.021$ and $C_L = 0.074$. The results show that 2D simulations can yield better results. Net surge and heave forces have been estimated using the Equations (12) and (13) respectively. As there are not much literature on this study, the results could not be verified.

$$X = F_D \cos \beta + F_L \sin \beta \quad (12)$$

$$Z = -F_D \sin \beta + F_L \cos \beta \quad (13)$$

Variation of the surge force, heave force and pitch moments with the angle of attack, β are shown in Figures 14, 15 and 16 respectively. The plots are also supplemented by a smoothing trend line.

The prediction of hydrodynamic forces and moments in the case of box-fish like bodies is not as straight forward as in the case of streamlined ships and submarines. The body being bluff, sheds vortices at moderate angles (say 7.5 deg) of attack which shows a sudden drop in surge and heave forces as well as in pitch moment. Later beyond 10 deg, the formation of vortices stabilizes and are expected to contribute

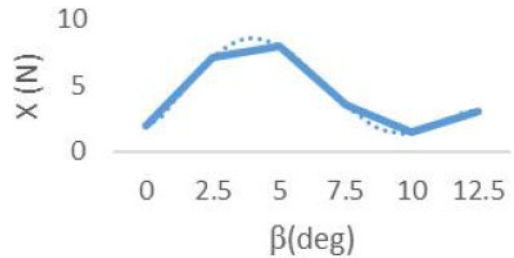

Figure 14. Variation of surge force with angle of attack.

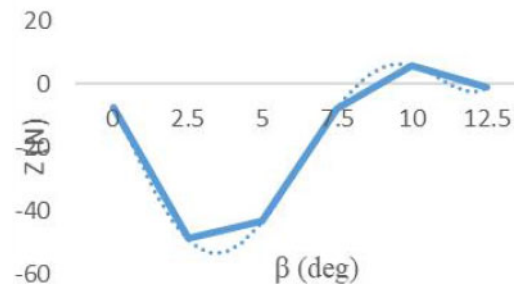

Figure 15. Variation of heave force with angle of attack.

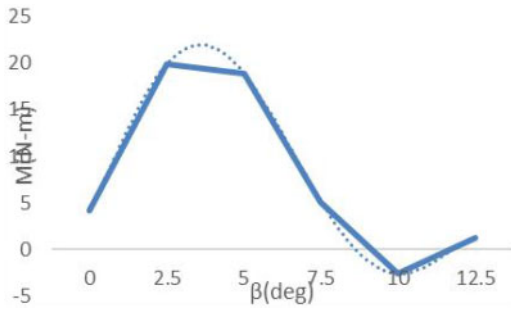

Figure 16. Variation of pitch moment with angle of attack.

to induced components of surge, heave and pitch and hence a rise in the trend is seen. The static manoeuvre simulation tests on further analysis provide the w dependent derivatives.

The propulsion simulation using the oscillation of the tail show an oscillating wake with very weak vortices shedding and disappearing in no time. Hence ostraciiform fish exhibits sluggish locomotion. The maximum thrust generated due to tail motion is found to be $X_T = 2.4N$.

Time histories of surge force, heave force and pitch moment when the UUV is subjected to pure sinusoidal heave motion is shown in Figure 17 plotted for one complete time period of oscillation (12.56 rad/s).

Similarly, the time histories of forces and moment in pitch and combined mode is shown in Figures 18 and 19.

These plots reveal that box-fish, due to its asymmetry about y - z plane doesn't produce symmetrical surge forces while its symmetry in x - z as well as x - y planes resulted in symmetrical heave forces and pitch moments. From heave simulations, the hydrodynamic coefficients that can be evaluated are X_w , Z_w and M_w . From the pitch simulations the derivatives X_q , Z_q and M_q can be evaluated. Combined mode simulations yield coupled derivatives which are not of interest to this paper. The other derivatives can also be evaluated considering the motions in the horizontal plane and also by considering roll into account.

6 CONCLUSIONS

Box-fish owing to its non-streamlined shape has poor controllability. They need extra thrust from the pectoral fins to supplement the thrust produced by the caudal fin. Their tail length is too short to generate reverse Von-Kármán vortex street of vortices for improved power. This tail form helps the fish in sustaining power for a longer time. Nevertheless, this work provides an initial frame work for the estimation of hydrodynamic derivatives for a UUV in the form of a box fish-the simplest possible mode of implementation for bio-inspired propulsion. 2D results have helped us in reasonable qualitative predictions. Quantitatively, the results are yet to be verified either with

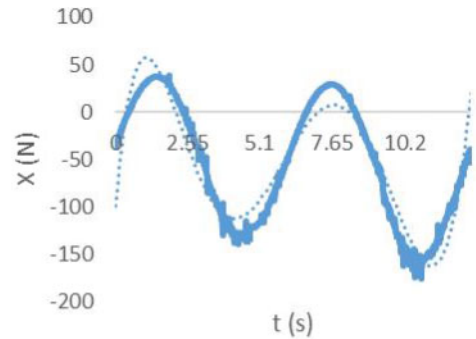

(a) Surge force

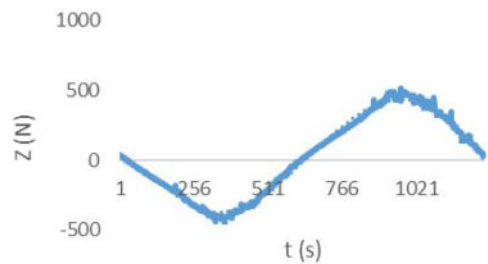

(b) Heave force

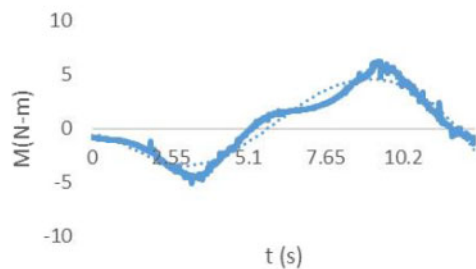

(c) Pitch moment

Figure 17. Time histories of forces and moment in heaving motion.

experimental or published ones. For more accurate prediction, overset grids and 3D models are suggested.

7 FUTURE WORK

Nature has its own way of compensating for the shortcomings imposed on its own creation. The carapace on the fish's body is believed to reduce drag and direct

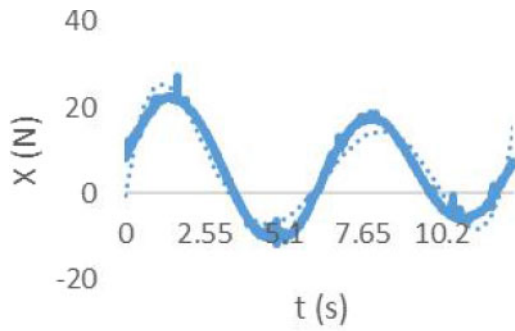

(a) Surge force

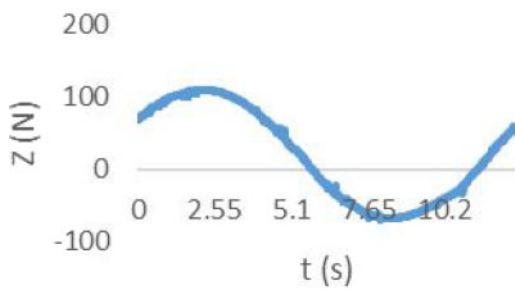

(b) Heave force

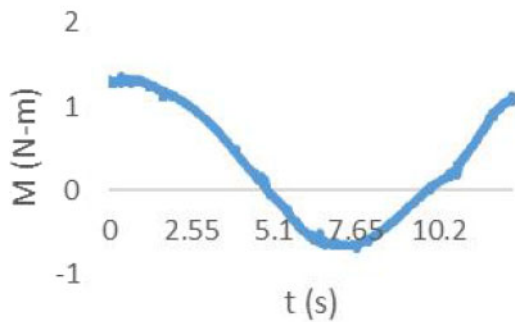

(c) Pitch moment

Figure 18. Time histories of forces and moment in pitching motion.

flow such that the fish attains better manoeuvrability (Van Wassenbergh, van Manen, Marcroft, Alfaro, & Stamhuis 2015). Moreover, the role of the pectoral fins in augmenting the thrust produced by caudal

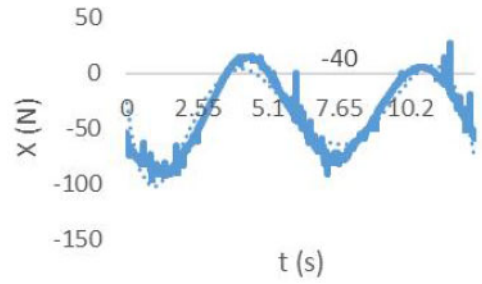

(a) Surge force

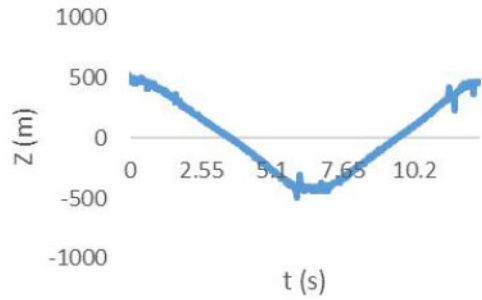

(b) Heave force

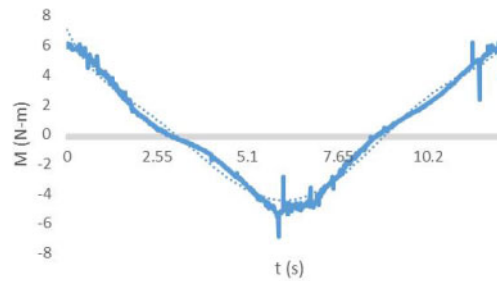

(c) Pitch moment

Figure 19. Time histories of forces and moment in surge motion.

fin is unexplored in the present work. The present work will be extended with the inclusion of carapace and pectoral fins in the future works. The hydrodynamic forces and moments will be analyzed using a Fourier series method (Janardhanan & Krishnankutty 2009) for obtaining the hydrodynamic derivatives of the hull form. The trajectories of the UUV in standard manoeuvres such a turning circle and zig-zag will be predicted to finally arrive at its controllability, counter-controllability and stability characteristics.

REFERENCES

- Blake, R. (1977). On ostraciiform locomotion. *Journal of the Marine Biological Association of the United Kingdom* 57(4), 1047–1055.
- Chandran, V., S. Janardhanan, V. Menon, et al. (2018). Numerical study on the influence of mass and stiffness ratios on the vortex induced motion of an elastically mounted cylinder for harnessing power. *Energies* 11(10), 2580.
- Hinojosa, M., C. Guedes Soares, & H. Xu (2018). Motion planning, guidance and control system for autonomous surface vessel. In *ASME 2018 37th International Conference on Ocean, Offshore and Arctic Engineering*, pp. V11BT12A016–V11BT12A016. American Society of Mechanical Engineers.
- Janardhanan, S. & P. Krishnankutty (2009). Prediction of ship maneuvering hydrodynamic coefficients using numerical towing tank model tests. In *12th Numerical Towing Tank Symposium*.
- Schlichting, H. & K. Gersten (2016). *Boundary-layer theory*. Springer.
- Van Wassenbergh, S., K. van Manen, T. A. Marcroft, M. E. Alfaro, & E. J. Stamhuis (2015). Boxfish swimming paradox resolved: forces by the flow of water around the body promote manoeuvrability. *Journal of the Royal Society Interface* 12(103), 20141146.
- Wu, Z., J. Yu, Z. Su, & M. Tan (2014). Implementing 3-d high maneuvers with a novel biomimetic robotic fish. *IFAC Proceedings Volumes* 47(3), 4861–4866.