

**SCMS SCHOOL OF ENGINEERING AND TECHNOLOGY, KARUKUTTY**

**ACADEMIC YEAR MAY 2020-JUNE 2021**

**3.5.1. Number of functional MoUs/linkages with institutions/ industries in India and abroad for internship, on-the-job training, project work, student / faculty exchange and collaborative research during the last five years**

Sl. No	Name of the MoU / linkage	Name of the institution / industry with whom the MoU / linkage is made, with contact details	Year of signing MoU / linkage	Purpose of the MoU/Linkage (nternship, on-the-job training, project work, student / faculty exchange and collaborative research)	Duration of MoU / linkage	List the actual activities under each MOU/ Linkage and web -links year-wise
1	MoU	Hungkuang University, Taiwan R.O.C, Dr. Yueh-guey Huang, President, Hungkuang University,	2018	Academic and cultural exchange between two countries	2018-2025	Student exchange, Faculty development, Academic programmes
2	MoU	Shimane University, Japan , Yasunao Hattori President Shimane University	2018	Student exchange and to promot research. education and academic culture	2018-2025	Student exchange as part of intership
3	MoU	Daffodil International University, Yousuff Mahbulul, Vice chancellor	2018	Academic aad cultural exch	2018-2023	Other Academic Activities
4	MoU	Kochi Metro Rail Limited, Managing Director, Kochi Metro Rail	2018	FIELD PROJECT	2018-2021	Field Project
5	MoU	Furtwangen University of Applied Sciences, Germany	2015	Joint conferences, Joint teaching	2015-tiil date	Interaction with B.Tech students

6	MoU	Hermann Sewerin GmbH	2015	Providing of qualified project support and support and training of staff or students	2015-till date	Organized workshop on leak detection and pipe locating were conducted at SSET
7	MoU	LimCo International GmbH, Germany	2015	For developing and applying new technologies and to adapt approved technologies to the specific tropical conditions	2015-till date	Student training at LimCo ,Germany
8	MoU	University of Applied Sciences Ravensburg-Weingarten, Germany	2015	Cultural exchange and exchange of undergraduate and graduate students as well as faculty	2015-2020	Student excgane and collaborative research
9	MoU	NIVUS GmbH	2015	For developing and applying new technologies and to adapt approved technologies to the specific tropical conditions	2015-till date	NIVUS provided equipment's worth several lakhs for SCMS Water Institute for technical teaching, demonstration and training

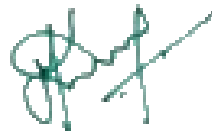

  
**DR. PRAVEENSAL C.J.**  
**PRINCIPAL**  
**SCMS SCHOOL OF ENGINEERING & TECHNOLOGY**



Since 1967

**HUNGKUANG**  
University



**SCMS**

GROUP OF EDUCATIONAL INSTITUTIONS

## MEMORANDUM OF UNDERSTANDING

between

**Hungkuang University (Taichung, Taiwan R.O.C)**

and

**SCMS Group of Educational Institutions (Kerala, India)**

---

Hungkuang University, located at Taichung, Taiwan R.O.C. and SCMS Group of Educational Institutions, located at Cochin, Kerala, India wish to develop academic/cultural exchange between the two institutions in education, research and other areas, and agree to formally establish a collaborative relationship with each other. Subject to mutual consent, the provisions of the agreement are as follows:

### Article I.

The areas of collaboration include any program offered by either university in which the two institutions believe collaboration is feasible and desirable and which would develop and enhance a mutually beneficial relationship between the two universities.

### Article II.

Subject to the approval of the President of each institution and the availability of funding, assistance shall be carried out through any one or more of the following activities or programs as mutually agreed to by both parties:

- i. Student Exchange Program
- ii. Faculty Exchange Program
- iii. Special Short-term Academic Programs
- iv. Staff Development Projects
- v. Joint Research and Activities

**Article III.**

This cooperation agreement shall become effective as soon as the presidents of both institutions sign it, and will remain in force for a period of five years. This MOU will be automatically renewed on the same terms and conditions for another five years unless either party raises a written notification 6 months prior to the date of expiration. Either party reserves the right to terminate this agreement upon a one-year prior written declaration by the terminating party.

**Article IV.**

Any amendment to this MOU shall be based on the mutual consent and requires the written approval of the President of each institution that shall be appended hereto. This declaration will become effective with the agreement of both parties.

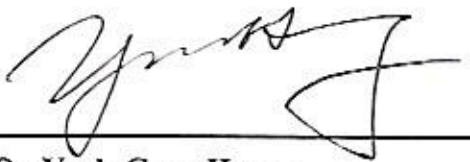

**Dr. Yueh-Guey Huang**  
**President**  
**Hungkuang University**



**Prof. Pramod P. Thevannoor**  
**Vice Chairman**  
**SCMS Group of Educational**  
**Institutions, India**

**Date:** Mar. 22, 2019

**Date:** 22/03/2014.

## MoU signings with International Universities

### ➤ **HUNG KUANG UNIVERSITY, TAIWAN**

SCMS Group of Educational Institutions signed a Memorandum of Understanding with Hung Kuang University, Taiwan on 22<sup>nd</sup> March 2019 for academic and research collaboration. Hung Kuang University is one of the top ranked Universities in the field of Health, Biomedical Engineering and Information Systems in Taiwan.



In the meeting held at Hung Kuang University Head Quarters in Taichung, Taiwan, Prof. Pramod P Thevannoor Vice Chairman SCMS Group and Dr. Laura Huang, President Hung Kuang University signed the MoU. During the discussions that followed, Dr. Sunil Jacob, Director SCMS Center for Robotics gave a presentation on the ongoing research projects at SCMS.

Based on the discussions, SCMS would provide necessary technology transfer and support for using the De-addiction electromagnetic coil developed at SCMS Center for Robotics in the ongoing research on bone Osteoporosis at Department of Biomedical Engineering, Hung Kuang University. SCMS would also provide necessary technology and assistance in the development of assistive technologies for the paralyzed persons. Both Institutions also agreed to collaborate on research projects such as IoT enabled flood detection systems and underwater Unmanned Aerial Vehicles. Based on the collaboration, students from SCMS would have an opportunity to do short term internships and Master Degree programs at Hung Kuang University.

**Members present at the meeting:**

Sitting (From Left): Prof. Sunil Jacob Director-SCMS Center for Robotics, Prof. Pramod P Thevannoor, Vice Chairman SCMS, Dr. Laura Huang, President Hung Kuang University and Dr. Shu Hung-Yee Executive Vice President Hung Kuang University.

**Standing (From Left)**

Mr. Jeffrey Lin International Relations Advisor Hung Kuang University, Prof. Tiger Tien Head of International Relations at Hung Kuang University, Dr. Varun G Menon, Associate Professor and International Relations-in charge at SCMS, Dr. Yeong-Yuh Xu, Director Department of Computer Science and Information Engineering, Dr. Taipau Chia Associate Professor Department of Safety, Health and Environmental Engineering and Dr. Ming-Tzu Tsai, Director Department of Biomedical Engineering

➤ **SHIMANE UNIVERSITY, JAPAN**

SCMS Group of Educational Institutions signed MoU with Shimane University, Japan on 18/12/2018 at SCMS campus, Kalamassery. As per the agreement, both institutions will collaborate on various areas in research and academics in Management and Engineering education sector. The MoU was signed between Prof. Pramod P Thevannoor, Vice Chairman of SCMS Group and Prof. Yasunano Hattori, President of Shimane University in a function held at SCMS campus in kalamassery. Five Students from SCMS Institutions have already done Internships at Shimane University in last two years. Three students from SCMS School of Engineering and Technology would be traveling to Shimane University in January 2019 for joining the Internship program. Based on the MoU more students from SCMS would be invited to Shimane University for Internships and training programs in subsequent years.

The MoU would also promote student and faculty exchange programs between the institutions. Both institutions would work on possible areas of research collaboration in robotics, environmental engineering, computer security and other engineering disciplines.



The delegation from Shimane University was led by Yasunano Hattori, President of Shimane University. Mr. Kouke Takahashi, International Student Center-in charge and Ms Miki Shimizu, Japanese Language Teacher at Shimane University was the other members of the delegation.

➤ **DAFFODIL INTERNATIONAL UNIVERSITY, BANGLADESH**

MoU signed by Prof. Dr. Yousuf Mahbubul Islam Vice Chancellor Daffodil International University (DIU) and Prof. Pramod, Vice Chairman SCMS. MoU signing was followed by discussions on possible collaborative programs between the two universities. Short term internship opportunities at SCMS for students from DIU was the major topic of discussion.







Varun Menon G &lt;varunmenon@scmsgroup.org&gt;

---

## Arrangement of talk for Hungkuang University

2 messages

---

國際處李昭妮 <peyton5400@hk.edu.tw>

Mon, May 18, 2020 at 10:34 AM

To: vinodp@scmsgroup.org

Cc: 田其虎國際長 &lt;tigert@hk.edu.tw&gt;, varunmenon@scmsgroup.org, pramod@scmsgroup.org, gopakumars@scmsgroup.org, praveensal@scmsgroup.org, 醫工系蔡明慈主任 &lt;anniemtt@sunrise.hk.edu.tw&gt;, 環安系盧信忠主任 &lt;hclu@sunrise.hk.edu.tw&gt;, 國際處楊蜀瑜秘書 &lt;gracetaiwan@hk.edu.tw&gt;, Fannie Leung &lt;fannie@hk.edu.tw&gt;

Dear Dr. Vinod,

Greetings!

I'm Peyton Lee, a coordinator of Hungkuang University International Office responsible for global collaboration projects.

It is undeniable that education has been hit particularly hard by the COVID-19 pandemic. School closures in countries worldwide, universities switch to online courses and endless of international exchange programs being put on hold.

Under such circumstances, we'd like to grab this opportunity to thank you for agreeing to deliver a webinar to our students and faculty, so that our collaboration gets to continue in a different way. The honor is definitely ours.

For us 27th May 10.30a.m. to 12.00p.m. your time is perfect. We would very much appreciate it if you could kindly send me your CV and topic you'd like to present, I'll then share with our departments. Also, I'll help set up the meeting room and send you the webinar link right after we have it confirmed.

Till I hear from you, take care and be safe!

Best regards,

Peyton Lee 李昭妮

Coordinator, Office of International and Cross-Strait Affairs 國際暨兩岸事務處

Hungkuang University 弘光科技大學

886-4-26318652 ext. 2233

---

Vinod P <vinodp@scmsgroup.org>

Mon, May 18, 2020 at 11:31 AM

To: 國際處李昭妮 &lt;peyton5400@hk.edu.tw&gt;

Cc: 田其虎國際長 &lt;tigert@hk.edu.tw&gt;, Varun Menon G &lt;varunmenon@scmsgroup.org&gt;, pramod p thevannoor &lt;pramod@scmsgroup.org&gt;, Gopakumar S &lt;gopakumars@scmsgroup.org&gt;, "Dr. Praveensal C.J." &lt;praveensal@scmsgroup.org&gt;, 醫工系蔡明慈主任 &lt;anniemtt@sunrise.hk.edu.tw&gt;, 環安系盧信忠主任 &lt;hclu@sunrise.hk.edu.tw&gt;, 國際處楊蜀瑜秘書 &lt;gracetaiwan@hk.edu.tw&gt;, Fannie Leung &lt;fannie@hk.edu.tw&gt;

### Good Morning

Thanks for inviting me to the talk. I am really excited to share my ideas regarding "Machine Learning Approaches for Detecting Malicious Code". In this talk I will discuss the following:

- [1] What is malware?
- [2] State of Art detection methods
- [3] Machine learning approaches for detecting malware
- [4] Attacks on machine learning-based malware scanners
- [5] Countermeasures
- [6] Ongoing Cybersecurity research at SCMS, Kerala, India

You can also suggest if something more needs to be discussed. I will share my CV and photograph by today evening.

Regards

Vinod

[Quoted text hidden]

--

*"Be less curious about people and more curious about ideas" --Marie Curie*

**Dr. Vinod P.**

***Professor & Head - Department of Computer Science & Engineering***

***SCMS School of Engineering and Technology***

***Ernakulam, Kerala, India, Pin code- 683582***



Varun Menon G <varunmenon@scmsgroup.org>

---

## Certificate of Appreciation by Hungkuang University

1 message

---

國際處李昭妮 <peyton5400@hk.edu.tw>  
To: "Dr. Varun G Menon" <varunmenon@scmsgroup.org>  
Cc: 田其虎國際長 <tigert@hk.edu.tw>

Fri, Jul 31, 2020 at 8:44 AM

Dear Dr. Varun,

Hope this email finds you well.

Attached please find the certificate of appreciation presented by Hungkuang University on your effort and time to deliver the talk on June 15. :-)

In case you need the hard copy, kindly let me know, I'll then post it to you.

Best,

Peyton Lee 李昭妮

Coordinator, Office of International and Cross-Strait Affairs 國際暨兩岸事務處

Hungkuang University 弘光科技大學

886-4-26318652 ext. 2233

---

 **Dr. Varun G Menon.pdf**  
599K



Varun Menon G <varunmenon@scmsgroup.org>

## Research Collaboration between SCMS and Hung Kuang University

5 messages

**Dr. Varun G Menon** <varunmenon@scmsgroup.org>

Fri, Apr 5, 2019 at 6:49 PM

To: anniemtt@sunrise.hk.edu.tw

Cc: Sunil Jacob <suniljacob@scmsgroup.org>, Pramod <pramod@scmsgroup.org>, 國際長田其虎 <tigert@sunrise.hk.edu.tw>, Gopakumar S <gopakumars@scmsgroup.org>, "Dr. Praveensal C.J." <praveensal@scmsgroup.org>, 林敬宗 <lin.jeffrey@hk.edu.tw>, 黃月桂校長 <laura@hk.edu.tw>

**Dear Dr. Ming Tzu Tsai,**

Hope you are having a wonderful time at Hung Kuang University. We were discussing on possible research collaboration opportunities between the two Institutes. As discussed during our visit, research collaboration on the application of the magnetic coil could be a very good start in this regard.

I am keeping the copy of the email to Dr. Sunil Jacob. Request both of you to take forward the discussion.

Dr. Sunil Jacob, Director, Center for Robotics, Email: [suniljacob@scmsgroup.org](mailto:suniljacob@scmsgroup.org)

Dr. Ming Tzu Tsai, Director, Department of Biomedical Engineering, Email: [anniemtt@sunrise.hk.edu.tw](mailto:anniemtt@sunrise.hk.edu.tw)

For any further information or help please feel free to contact me. We look forward to start the active partnership between the Institutes at the earliest.

Thanks and Regards,

**Dr. Varun G Menon**

Associate Professor, Computer Science Engineering

*ACM Distinguished Speaker*

*Guest Editor Journal of Supercomputing (Cyberphysical Systems)*

Corporate Relations and International Collaborations-in charge

SCMS School of Engineering and Technology

SCMS Group of Educational Institutions

Karukutty, Ernakulam, Kerala, India - 683 582

Office: +91-484-2450330 Mob: +91-8714504684

Web: <http://www.scmsgroup.org>



**SCMS**

GROUP OF EDUCATIONAL INSTITUTIONS

**弘光醫工系-蔡明慈 Tsai MT** <anniemtt@sunrise.hk.edu.tw>

Fri, Apr 12, 2019 at 4:35 PM

To: varunmenon@scmsgroup.org

Cc: Tiger <tigert@hk.edu.tw>, HK1醫工1-陳信介 <hcchen@sunrise.hk.edu.tw>, suniljacob@scmsgroup.org

Dear Prof. Menon,

Thank you for the email and we are delighted and looking forward to the research collaboration between the institutes.

Although I do not have any idea about how to start the collaboration, my colleagues and I would love to discuss if you have any thought or plan.

Sincerely,

MTT

-----  
Annie Ming-Tzu Tsai  
Associated Professor, Director  
Department of Biomedical Engineering  
HUNGKUANG UNIVERSITY  
1018, Sec. 6, Taiwan Boulevard, Shalu District  
Taichung City 43302, TAIWAN

Mobile: 0928-634-434  
TEL: 886-4-2631-8652 ext. 4300  
FAX: 886-4-2631-3871  
E-mail: [anniemtt@sunrise.hk.edu.tw](mailto:anniemtt@sunrise.hk.edu.tw)  
[anniemtt@gmail.com](mailto:anniemtt@gmail.com)  
-----

**From:** Tiger [<mailto:tigert@hk.edu.tw>]  
**Sent:** Tuesday, April 09, 2019 12:43 PM  
**To:** [anniemtt@sunrise.hk.edu.tw](mailto:anniemtt@sunrise.hk.edu.tw)  
**Subject:** Fwd: Research Collaboration between SCMS and Hung Kuang University

----- Forwarded message -----

**From:** Dr. Varun G Menon <[varunmenon@scmsgroup.org](mailto:varunmenon@scmsgroup.org)>  
**Date:** Fri, Apr 5, 2019 at 21:19  
**Subject:** Research Collaboration between SCMS and Hung Kuang University  
**To:** <[anniemtt@sunrise.hk.edu.tw](mailto:anniemtt@sunrise.hk.edu.tw)>  
**CC:** Sunil Jacob <[suniljacob@scmsgroup.org](mailto:suniljacob@scmsgroup.org)>, Pramod <[pramod@scmsgroup.org](mailto:pramod@scmsgroup.org)>, 國際長田其虎 <[tigert@sunrise.hk.edu.tw](mailto:tigert@sunrise.hk.edu.tw)>, Gopakumar S <[gopakumars@scmsgroup.org](mailto:gopakumars@scmsgroup.org)>, Dr. Praveensal C.J. <[praveensal@scmsgroup.org](mailto:praveensal@scmsgroup.org)>, 林敬宗 <[lin.jeffrey@hk.edu.tw](mailto:lin.jeffrey@hk.edu.tw)>, 黃月桂校長 <[laura@hk.edu.tw](mailto:laura@hk.edu.tw)>

Dear Dr. Ming Tzu Tsai,

Hope you are having a wonderful time at Hung Kuang University. We were discussing on possible research collaboration opportunities between the two Institutes. As discussed during our visit, research collaboration on the application of the magnetic coil could be a very good start in this regard.

I am keeping the copy of the email to Dr. Sunil Jacob. Request both of you to take forward the discussion.

Dr. Sunil Jacob, Director, Center for Robotics, Email: [suniljacob@scmsgroup.org](mailto:suniljacob@scmsgroup.org)

Dr. Ming Tzu Tsai, Director, Department of Biomedical Engineering, Email: [anniemtt@sunrise.hk.edu.tw](mailto:anniemtt@sunrise.hk.edu.tw)

For any further information or help please feel free to contact me. We look forward to start the active partnership between the Institutes at the earliest.

Thanks and Regards,

**Dr. Varun G Menon**

Associate Professor, Computer Science Engineering

*ACM Distinguished Speaker*

*Guest Editor Journal of Supercomputing (Cyberphysical Systems)*

Corporate Relations and International Collaborations-in charge

SCMS School of Engineering and Technology

SCMS Group of Educational Institutions

Karukutty, Ernakulam, Kerala, India - 683 582

Office: +91-484-2450330 Mob: +91-8714504684

Web: <http://www.scmsgroup.org>



**SCMS**  
GROUP OF EDUCATIONAL INSTITUTIONS

--

Tiger田其虎

弘光科技大學國際暨兩岸事務處國際長

Dean, Office of International and Cross-Strait Affairs

台灣台中市沙鹿區台灣大道六段1018號

No. 1018, Sec. 6, Taiwan Boulevard, Shalu District, Taichung City 43302, Taiwan (R.O.C.)

[tigert@hk.edu.tw](mailto:tigert@hk.edu.tw)

+886-4-22363663 EX 7300

+886-921892821

---

**Sunil Jacob** <[suniljacob@scmsgroup.org](mailto:suniljacob@scmsgroup.org)>

Tue, Apr 16, 2019 at 10:41 AM

To: 弘光醫工系-蔡明慈 Tsai MT <[anniemtt@sunrise.hk.edu.tw](mailto:anniemtt@sunrise.hk.edu.tw)>

Cc: Varun Menon G <[varunmenon@scmsgroup.org](mailto:varunmenon@scmsgroup.org)>, Tiger <[tigert@hk.edu.tw](mailto:tigert@hk.edu.tw)>, HK1醫工1-陳信介 <[hcchen@sunrise.hk.edu.tw](mailto:hcchen@sunrise.hk.edu.tw)>, Pramod P Thevannoor <[pramod@scmsgroup.org](mailto:pramod@scmsgroup.org)>, Gopakumar S <[gopakumars@scmsgroup.org](mailto:gopakumars@scmsgroup.org)>, "Dr. Praveensal C.J." <[praveensal@scmsgroup.org](mailto:praveensal@scmsgroup.org)>

Dear Annie Ming-Tzu Tsai

Thank you for your mail.

Hope you all are doing well.

As discussed I would like to detail about our project Smart EM coil for the study of Osteoporosis, or porous bone, It is a disease characterized by low bone mass and structural deterioration of bone tissue, leading to bone fragility and an increased risk of fractures of the hip, spine, and wrist. Men as well as women are affected by osteoporosis, a disease that can be prevented and treated.

We can make the smart EM coil for the required value of Tesla which u can use to test and validate the result for the above mentioned cause.

The device is modeled and we are testing it for Rejuvenation of the human cell.  
 The technical detail schematic, PCB layout and the device model is attached for your reference.  
 After validating the result we can publish our research collaboration in peer reviewed journals.  
 The international patent can be filled and the product can be released in the market.  
 Thank you Varun Sir for initiating the process.

Regards,  
 Dr. Sunil Jacob  
 Director SCMS Centre for Robotics  
 Professor Electronics and Communication Engineering Department



SCMS School of Engineering & Technology  
 Karukutty, Cochin - 683 582  
 Kerala  
 India

[Quoted text hidden]

--

### 3 attachments

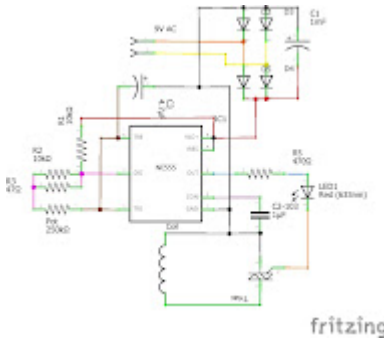

**ROC Schematics\_Taiwan\_schem.jpg**  
133K



**Smart Magnetic coil.jpg**  
2023K



弘光醫工系-蔡明慈 Tsai MT <anniemtt@sunrise.hk.edu.tw>

Mon, Apr 22, 2019 at 1:23 PM

To: Sunil Jacob <suniljacob@scmsgroup.org>

Cc: Varun Menon G <varunmenon@scmsgroup.org>, Tiger <tigert@hk.edu.tw>, HK1醫工1-陳信介 <hcchen@sunrise.hk.edu.tw>, Pramod P Thevannoor <pramod@scmsgroup.org>, Gopakumar S <gopakumars@scmsgroup.org>, "Dr. Praveensal C.J." <praveensal@scmsgroup.org>

Dear Prof. Jacob,

I hope you are doing well and thank you for your kindness for providing the details and research information to this work.



My previous study was to determine the effect of PEMF with the extremely low frequency (ELF) on osteoblasts and osteoclasts for the inhibition of osteoporosis.

The parameters we used were: 7.5 Hz and 0.13 mT .

I am not sure the magnetic intensity produced by PEMF coil has similar effect to the Helmholtz coils. It need to be further confirmed or tested.

I am very glad that we have did a good start of the research collaboration. To well perform this project, I suggest we could go through it individually. Based on Prof. Jacob's expertise, your team could modify the EMF producer as a "smart EMF," and the in vitro stud could be done in my Lab. Or my colleagues could be joined to this project to develop the EMF producer. We can have further discussion if you have any thought about this project or the way how we are going to do.

Best regards,

MTT

Sunil Jacob <[suniljacob@scmsgroup.org](mailto:suniljacob@scmsgroup.org)> 於 2019年4月16日 週二 下午1:11寫道:

[Quoted text hidden]

--

Best regards,

Tsai MT

---

Annie Ming-Tzu Tsai  
Associated Professor, Director  
Department of Biomedical Engineering  
HUNGKUANG UNIVERSITY  
1018, Sec. 6, Taiwan Boulevard, Shalu District  
Taichung City 43302, TAIWAN  
TEL: 886-4-2631-8652 ext. 4310 / 4316  
FAX: 886-4-2631-3871  
E-mail: [anniemtt@sunrise.hk.edu.tw](mailto:anniemtt@sunrise.hk.edu.tw)  
[anniemtt@hk.edu.tw](mailto:anniemtt@hk.edu.tw)

---

---

Sunil Jacob <[suniljacob@scmsgroup.org](mailto:suniljacob@scmsgroup.org)>

Wed, Apr 24, 2019 at 12:48 PM

To: 弘光醫工系-蔡明慈 Tsai MT <[anniemtt@sunrise.hk.edu.tw](mailto:anniemtt@sunrise.hk.edu.tw)>

Cc: Varun Menon G <[varunmenon@scmsgroup.org](mailto:varunmenon@scmsgroup.org)>, Tiger <[tigert@hk.edu.tw](mailto:tigert@hk.edu.tw)>, HK1醫工1-陳信介 <[hcchen@sunrise.hk.edu.tw](mailto:hcchen@sunrise.hk.edu.tw)>, Pramod P Thevannoor <[pramod@scmsgroup.org](mailto:pramod@scmsgroup.org)>, Gopakumar S <[gopakumars@scmsgroup.org](mailto:gopakumars@scmsgroup.org)>, "Dr. Praveensal C.J." <[praveensal@scmsgroup.org](mailto:praveensal@scmsgroup.org)>

Dear Dr Annie,

Thank you for your mail and hope you all are doing great

Yes definitely we can work in this direction.

We in fact will modify and develop the device for variable duty cycle.

It will work for variable frequency from 0Hz to 50 Hz.

The advantage is that we can study the effect at different frequencies.

The coil for different turns ratio can be designed.

Regarding Helmholtz coil generating PEMF.

I got a reference link

[https://www.drjohn1.com/wp-content/uploads/2016/11/018\\_PERIODONTITIS\\_jbpe-4-83.pdf](https://www.drjohn1.com/wp-content/uploads/2016/11/018_PERIODONTITIS_jbpe-4-83.pdf)

Please go thru it. We can easily model it depending on the variable turn ratio, frequency and the distance between the coil.

Yes dear Annie you can definitely test and validate the device in your lab.

While developing the coil you can connect me with your colleagues who would like to work in this direction.

**So I am on the design of the smart PEMF coil for variable frequency and Tesla. In July when u will be at SCMS with your team**

**I will demonstrate the same with your mentioned specification.**

Thank you for all your valuable inputs

It was great we feel the collaboration will work.

Thank you all

[Quoted text hidden]

--

[Quoted text hidden]

弘光科技大學  
HUNGKUANG  
University

# Certificate of Appreciation

This is presented to

*DR. Varun G Menon*

For imparting his valuable wisdom and expertise as a speaker in a

webinar entitled,

*“COVID-19 Impact and Opportunities for Students”*

Held on June 15, 2020.

校長 黃月桂

President Yueh Guey Huang

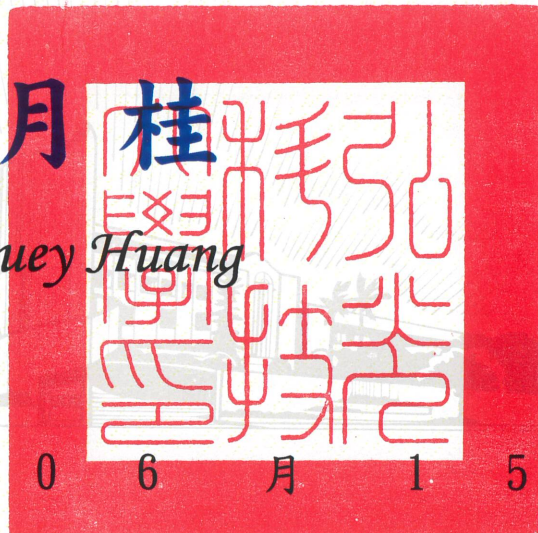

2 0 2 0 年 0 6 月 1 5 日

**AGREEMENT OF COOPERATION  
BETWEEN  
SCMS  
AND  
SHIMANE UNIVERSITY**

SCMS, INDIA and Shimane University, JAPAN herewith agree on the following:

1. SCMS and Shimane University will try to cooperate in the spirit of mutual understanding to establish close friendly relations.
2. SCMS and Shimane University will promote the exchange of students, faculty, research, education and academic culture. The details necessary to promote these exchanges will be worked out separately.
3. Through the above activities, SCMS and Shimane University endeavor to improve the educational and academic cultures of both countries, while at the same time promoting greater friendship and contributing to international understanding, goodwill, and peace.
4. This Agreement shall take effect upon the date of the signatures of the Vice Chairman of SCMS and the President of Shimane University, and shall remain in effect for five years from the date of the signatures. For the renewal of this Agreement, SCMS and Shimane University shall enter into negotiations within six months of its expiration.
5. This Agreement may be pre-terminated upon written notice to the other party without prejudice to the completion of any existing exchange and joint program.
6. This Agreement is to be executed in English and each party shall retain a copy.

(Signature)



Pramod Prathapachandran Thevannoor  
Vice Chairman  
SCMS

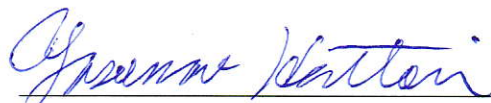

Yasunao Hattori  
President  
Shimane University

Date 18/12/2018

Date 18/12/2018

**A SUPPLEMENTARY AGREEMENT FOR STUDENT EXCHANGE  
BETWEEN  
SCMS  
AND  
SHIMANE UNIVERSITY**

SCMS, INDIA and Shimane University, JAPAN herewith agree to the following provision of cooperation on the basis of article 2 of the Principal Agreement for the purpose of promoting student exchange between the two parties.

(Exemption of the Tuition of Students)

1. SCMS and Shimane University shall waive the examination fee, the entrance fee and the tuition of the students who are accepted on the basis of this Supplementary Agreement.

(Exchange Student Number and Period of Exchange)

2. On the basis of the above provision 1, SCMS and Shimane University may send up to two students each year, making an effort to balance the number of students.
3. SCMS and Shimane University shall send students to the other party for a period of six months or no more than one full academic year at the beginning of a semester of the host party.

(Selection of Students)

4. SCMS and Shimane University shall take reasonable care to ensure the students to be recommended are capable of having sufficient knowledge in their academic fields and language ability necessary to study at the host party.

(Student Status)

5. SCMS and Shimane University shall allow students to be enrolled as non-degree students (Special Auditing Students or Special Research Students).

(Credits)

6. University credits earned at the host party may be honored by the student's home party.

(Financing)

7. Travel expenses, living expenses, books and supplies, and all other personal necessary expenses are the responsibility of individual students. Exchange students will be required to purchase health insurance valid in the host country and insurance for accidents especially designed for foreign students before their travel to the host country.

(Terms of Supplementary Agreement)

8. This Supplementary Agreement shall come into effect upon the latter date of the signatures below and shall remain in effect for five years on the condition that any amendments in that period must be agreed upon in writing by SCMS and Shimane University.

(Extension of Supplementary Agreement)

9. For the renewal of this Supplementary Agreement, SCMS and Shimane University shall enter into negotiations within six months of its expiration.

(Agreement Documents)

10. This Supplementary Agreement is executed in English and each party shall retain a copy.

(Signature)



Pramod Prathapachandran Thevannoor  
Vice Chairman  
SCMS

Date \_\_\_\_\_



Yasunao Hattori  
President  
Shimane University

Date 18/12/2018



Varun Menon G <varunmenon@scmsgroup.org>

## Regarding the renewal of Agreement

15 messages

国際課国際連携G <ied-koryu@office.shimane-u.ac.jp>  
To: "Dr. Varun G Menon" <varunmenon@scmsgroup.org>

Wed, Sep 13, 2023 at 8:23 AM

Dear Dr. Varun G Menon,  
International Relations  
SCMS School of Engineering and Technology,

Warmest greetings from Shimane University, Japan!

My name is KITAO Chiaki, an administrative staff of the International Division at Shimane University, Japan. I am responsible for managing our partnerships with other universities. Taking this opportunity, I would like to express our sincere appreciation for your valuable cooperation in maintaining our academic relationship over the years. I am pleased to inform you that the Academic Agreement between SCMS and Shimane University will expire in December, and it is time to discuss the renewal of the agreement. Shimane University is willing to continue our partnership for another 5 years, and we would be grateful if you could let us know your intentions regarding this matter.

Attached to this email, you will find the draft of the AOC and SEA for review.

Please feel free to contact me if you have any questions or concerns. We sincerely hope to receive your positive response soon.

Sincerely yours,

Chiaki,

--

\*-----\*

KITAO Chiaki (Ms)  
International Div.  
SHIMANE UNIVERSITY  
1060 Nishikawatsu, Matsue, Shimane  
690-8504, JAPAN  
tel:+81-(0)852-32-9735  
fax:+81-(0)852-32-6481  
[e-mail:ied-koryu@office.shimane-u.ac.jp](mailto:ied-koryu@office.shimane-u.ac.jp)

\*-----\*

### 2 attachments

 **Draft\_AOC\_SCMS\_SU.doc**  
48K

 **Draft\_SEA\_SCMS\_SU.doc**  
35K

Dr. Varun G Menon <varunmenon@scmsgroup.org>  
To: PRINCIPAL SSET <principalsset@scmsgroup.org>

Mon, Sep 18, 2023 at 11:26 AM

Ma'am,  
Please find the request for renewal of collaboration from Shimane University. Looking forward to your approval

[Quoted text hidden]

--

**Thanks and Regards,**

**Dr. Varun G Menon, Senior Member IEEE**  
Professor and Head  
Department of Computer Science and Engineering  
International Collaborations -in charge  
SCMS School of Engineering and Technology  
SCMS Group of Educational Institutions  
Kerala, India - 683 576, Mob: +91 8714504684

---

Associate Editor - Physical Communications Journal, Elsevier  
Series Editor - IEEE Transactions on Intelligent Transportation Systems  
Series Editor - IEEE Communications Standards Magazine  
Technical Editor - Computer Communications Journal, Elsevier  
Associate Editor - Alexandria Engineering Journal, Elsevier  
Associate Editor - IET Networks  
Editorial Member - IEEE Future Directions Newsletter

---

## 2 attachments

 **Draft\_AOC\_SCMS\_SU.doc**  
48K

 **Draft\_SEA\_SCMS\_SU.doc**  
35K

---

**Dr. Varun G Menon** <varunmenon@scmsgroup.org>  
To: 国際課国際連携G <ied-koryu@office.shimane-u.ac.jp>  
Cc: PRINCIPAL SSET <principalsset@scmsgroup.org>

Mon, Sep 18, 2023 at 11:27 AM

Dear Ms. KITAO Chiaki,

Thank you very much for the email. I will get back to you as soon as possible.

Regards

[Quoted text hidden]

[Quoted text hidden]

---

**PRINCIPAL SSET** <principalsset@scmsgroup.org>  
To: "Dr. Varun G Menon" <varunmenon@scmsgroup.org>

Mon, Sep 18, 2023 at 1:33 PM

Noted. Will revert. Let me know the period (from and to) of last agreement.

Regards,

---

**Dr. Anitha G. Pillai** |

Principal



**SCMS**  
School of Engineering & Technology

SCMS School of Engineering & Technology (SSET)  
Vidya Nagar, Palissery, Karukutty - 683 576, Kerala, India.  
Tel: 91-484-2882901  
Mob: 9497775295  
e-mail: [principalsset@scmsgroup.org](mailto:principalsset@scmsgroup.org)  
[anithagpillai@scmsgroup.org](mailto:anithagpillai@scmsgroup.org)

[Quoted text hidden]

---

**Dr. Varun G Menon** <varunmenon@scmsgroup.org>  
To: PRINCIPAL SSET <principalsset@scmsgroup.org>

Mon, Sep 18, 2023 at 1:40 PM

Ma'am,  
Please find the attached signed MoU(previous).

Regards

[Quoted text hidden]

---

 **Shimane University - Agreement of Cooperation.pdf**  
507K

---

**PRINCIPAL SSET** <principalsset@scmsgroup.org>  
To: "Dr. Varun G Menon" <varunmenon@scmsgroup.org>

Mon, Sep 18, 2023 at 1:51 PM

Noted  
Regards,

---  
**Dr. Anitha G. Pillai** |  
Principal



SCMS School of Engineering & Technology (SSET)  
Vidya Nagar, Palissery, Karukutty - 683 576, Kerala, India.  
Tel: 91-484-2882901  
Mob: 9497775295  
e-mail: [principalsset@scmsgroup.org](mailto:principalsset@scmsgroup.org)  
[anithagpillai@scmsgroup.org](mailto:anithagpillai@scmsgroup.org)

[Quoted text hidden]

---

**PRINCIPAL SSET** <principalsset@scmsgroup.org>  
To: "Dr. Varun G Menon" <varunmenon@scmsgroup.org>, HOD Computer Science Engineering Department <hodcssset@scmsgroup.org>, HOD Artificial Intelligence and Data Science <hoddsaisset@scmsgroup.org>

Tue, Sep 19, 2023 at 9:50 AM

Do needful to get the new agreement signed.  
Regards,

---  
**Dr. Anitha G. Pillai** |  
Principal



SCMS School of Engineering & Technology (SSET)  
Vidya Nagar, Palissery, Karukutty - 683 576, Kerala, India.  
Tel: 91-484-2882901  
Mob: 9497775295  
e-mail: [principalsset@scmsgroup.org](mailto:principalsset@scmsgroup.org)  
[anithagpillai@scmsgroup.org](mailto:anithagpillai@scmsgroup.org)

[Quoted text hidden]

---

**Dr. Varun G Menon** <varunmenon@scmsgroup.org>  
To: PRINCIPAL SSET <principalsset@scmsgroup.org>  
Cc: HOD Computer Science Engineering Department <hodcssset@scmsgroup.org>, HOD Artificial Intelligence and Data Science <hoddsaisset@scmsgroup.org>

Tue, Sep 19, 2023 at 10:00 AM

Noted ma'am.  
Will do the needful and update you  
[Quoted text hidden]

---

**Dr. Varun G Menon** <varunmenon@scmsgroup.org>  
To: 国際課国際連携G <ied-koryu@office.shimane-u.ac.jp>

Tue, Sep 19, 2023 at 1:31 PM



Cc: PRINCIPAL SSET <principalsset@scmsgroup.org>, HOD Computer Science Engineering Department <hodcssset@scmsgroup.org>

Dear Ms. KIATO Chiaki,

We have gone through the draft AOC and are happy to proceed with the collaboration for the next 5 years. Please let me know the next steps required.

Regards,  
Varun

[Quoted text hidden]

[Quoted text hidden]

---

国際課国際連携G <ied-koryu@office.shimane-u.ac.jp>

Wed, Sep 20, 2023 at 6:42 AM

To: "Dr. Varun G Menon" <varunmenon@scmsgroup.org>

Cc: PRINCIPAL SSET <principalsset@scmsgroup.org>, HOD Computer Science Engineering Department <hodcssset@scmsgroup.org>

Dear Dr. Varun G Menon,

Thank you for your response. We are pleased to know that SCMS has agreed to update our Agreement.

However, we would like to inform you that we need to obtain approval from our university committee before renewing the agreement. Once we receive the approval, we can proceed to the signing step.

Therefore, we kindly request a few months to complete our internal process. We will keep you updated on any progress made.

We apologize for any inconvenience caused and appreciate your patience and understanding.

Thank you and have a great day!

Sincerely,

Chiaki,

-----  
KITAO Chiaki,  
International Div.  
Shimane University

On 2023/09/19 17:01, Dr. Varun G Menon wrote:

Dear Ms. KIATO Chiaki,

We have gone through the draft AOC and are happy to proceed with the collaboration for the next 5 years. Please let me know the next steps required.

Regards,  
Varun

[Quoted text hidden]

<mailto:e-mail%3Aied-koryu@office.shimane-u.ac.jp>

\*-----\*

--

\*Thanks and Regards,\*

\*

\*

\*Dr. Varun G Menon, \*/Senior //Member IEEE/

[Quoted text hidden]

---

Dr. Varun G Menon <varunmenon@scmsgroup.org>

Wed, Sep 20, 2023 at 10:45 AM

To: 国際課国際連携G <ied-koryu@office.shimane-u.ac.jp>  
Cc: PRINCIPAL SSET <principalsset@scmsgroup.org>, HOD Computer Science Engineering Department <hodcssset@scmsgroup.org>

Dear Ms. KITAO Chiaki,

Thank you for the reply. Looking forward to further updates from you.

Regards,  
Varun

[Quoted text hidden]

--

**Thanks and Regards,**

**Dr. Varun G Menon, Senior Member IEEE**

[Quoted text hidden]

---

国際課国際連携G <ied-koryu@office.shimane-u.ac.jp> Thu, Dec 7, 2023 at 8:16 AM  
To: "Dr. Varun G Menon" <varunmenon@scmsgroup.org>  
Cc: PRINCIPAL SSET <principalsset@scmsgroup.org>, HOD Computer Science Engineering Department <hodcssset@scmsgroup.org>

Dear Dr. Varun G Menon,

Greetings from Shimane University!

I am sorry to have kept you waiting so long, but I am pleased to inform you that we have got approval from the internal meeting to renew our agreement, and now we are ready to sign.

I am arranging to have our president signature first, and would like to send the signed documents to you for your president's signature.

Could you please let me know your mailing address?

Thank you for your kind patience.  
Looking forward to hearing from you.

Sincerely,

Chiaki,

-----  
KITAO Chiaki,  
International Div.  
Shimane University

[Quoted text hidden]

---

**Dr. Varun G Menon** <varunmenon@scmsgroup.org> Fri, Dec 8, 2023 at 3:26 PM  
To: 国際課国際連携G <ied-koryu@office.shimane-u.ac.jp>  
Cc: PRINCIPAL SSET <principalsset@scmsgroup.org>

Dear Chiaki,

Thank you for sharing the wonderful news. Please find the mailing address below. If possible, please send me the document tracking ID once you post it.

**Dr. Varun G Menon,**  
Deputy Dean (Research & Development)  
Professor - Computer Science and Engineering  
International Collaborations -in charge  
SCMS School of Engineering and Technology, Kerala,  
India - 683 576

**MOBILE: +91 8714504684**

Regards,  
Varun

[Quoted text hidden]

--

**Thanks and Regards,**

**Dr. Varun G Menon**, *Senior Member IEEE*  
Deputy Dean (Research & Development)  
Professor - Computer Science and Engineering  
International Collaborations -in charge  
SCMS School of Engineering and Technology  
SCMS Group of Educational Institutions, Kerala, India - 683 576

-----  
Area Editor - Physical Communications Journal, Elsevier

[Quoted text hidden]

---

**国際課国際連携G** <ied-koryu@office.shimane-u.ac.jp>  
To: "Dr. Varun G Menon" <varunmenon@scmsgroup.org>  
Cc: PRINCIPAL SSET <principalsset@scmsgroup.org>

Tue, Dec 12, 2023 at 5:46 AM

Dear Dr. Varun G Menon,

Thank you for your reply.

I will post the signed agreement via EMS today and it's tracking number is "EN289370901JP".

Once your president sign the agreement, I would like to ask you to send one copy back to us the following address for our record.

KITAO CHIAKI  
International Division, Shimane University  
1060 Nishikawatsu-cho, Matsue, Shimane 690-8504, JAPAN  
TEL:+81-852-32-9735

Thank you for your cooperation.

Sincerely,

Chiaki,

-----  
KITAO Chiaki  
International Div.  
Shimane University

On 2023/12/08 18:56, Dr. Varun G Menon wrote:

Dear Chiaki,

Thank you for sharing the wonderful news. Please find the mailing address below. If possible, please send me the document tracking ID once you post it.

\*Dr. Varun G Menon, \*  
Deputy Dean (Research & Development)  
Professor - Computer Science and Engineering  
International Collaborations -in charge  
SCMS School of Engineering and Technology, Kerala,  
India - 683 576

\*MOBILE: +91 8714504684\*

\*

\*

Regards,  
Varun

[Quoted text hidden]

>> <<mailto:ied-koryu@office.shimane-u.ac.jp>>

[Quoted text hidden]

>> <<mailto:e-mail%3Aied-koryu@office.shimane-u.ac.jp>>  
<<mailto:e-mail%253Aied-koryu@office.shimane-u.ac.jp>>>

[Quoted text hidden]

[Quoted text hidden]

---

**Dr. Varun G Menon** <[varunmenon@scmsgroup.org](mailto:varunmenon@scmsgroup.org)>

Tue, Dec 12, 2023 at 5:48 AM

To: 国際課国際連携G <[ied-koryu@office.shimane-u.ac.jp](mailto:ied-koryu@office.shimane-u.ac.jp)>

Cc: PRINCIPAL SSET <[principalsset@scmsgroup.org](mailto:principalsset@scmsgroup.org)>

Dear Chiaki,

Thank you for the EMS details. Once received I will update you.

Regards

[Quoted text hidden]

--

**Thanks and Regards,**

**Dr. Varun G Menon**, *Senior Member IEEE*

[Quoted text hidden]



Varun Menon G &lt;varunmenon@scmsgroup.org&gt;

## Invitation of Applications from SCMS for MATSUE INTERNSHIP PROGRAM - JAN 28 - FEB 10 , 2024 in Matsue city, JAPAN - Deadline: MAY 31, 2023

18 messages

Asa Kerala &lt;asanipponkerala@gmail.com&gt;

Fri, Apr 28, 2023 at 10:54 PM

To: Varun Menon SCMS &lt;varunmenon@scmsgroup.org&gt;

Cc: Gopakumar S &lt;meenagopan1984@gmail.com&gt;, T J Thomas &lt;tjthomas.6125@gmail.com&gt;, Subhash T J &lt;tjsubhash@gmail.com&gt;, bebymathew@gmail.com, MADHU S NAIR &lt;cmd@cochinshipyard.com&gt;, Edgar Morris &lt;edgarfmorris@gmail.com&gt;, Hudson Peter &lt;hudsonpeter4@gmail.com&gt;

Dear Dr. Varun G Menon,

Greetings.

This has reference to the telephonic discussion we had last week on the invitation of Applications of candidates for Matsue Internship Program in Japan this year.

As you are aware, the formal name of the Program is Lake Nakaumi, Lake Shinji & Mt. Daisen Region Indian Human Resources Intake and Business Alliance Promotion Project. This Program is organized by Matsue City Authorities in association with AOTS, Tokyo and ASA Kerala. This time the Program will be in February 2024.

As usual, we have received the Program Announcement for this year from Matsue City Authorities. They are inviting the 3rd and 4th year Engineering students of 2023-24.

The following documents of the Program are attached.

1. Application Guidelines
2. Program Flyer
3. Application form

You may please note that as usual, they are inviting only a total of 6 (SIX) students from three Colleges, for this Internship. Further, they have included non-IT Branches of Engineering also.

**This internship program will provide the participants an opportunity to get selected for employment in Japan.**

Matsue City Authorities have separately indicated that they mostly prefer Pre-final year students, as the students have more time to plan and will be more inclined to accept opportunities in Japan.

Kindly make your recommendations as follows.

1. Four Applicants from Pre-Final Year students of IT, Computer Science and other Branches of Engineering
2. Two Applicants from Final Year students. Please select them based on their strong intention to take employment in Japan.

The Applicants should meet the qualifications specified in Para 3 of the Application Guidelines.

**As instructed in Para 11 of the Guidelines, please send us the filled up Application forms both in EXCEL Format and PDF files along with scanned copies of the supporting documents. Also please attach copies of their passports.**

Please take care to write the **Name of the Applicant as written in the Passport.**

**APPLICATION DEADLINE: MAY 31, 2023 at Nippon Kerala Centre**

**The Candidates may have to appear for an Interview at Nippon Kerala Centre after submission. The Date of the Interview shall be informed later. We will be selecting two students from among them.**

We will forward the Applications of the selected students to the Matsue city Authorities in Japan by the first week of June 2023.

Matsue will announce the names of the approved candidates by end June 2023.

The approved candidates will have to attend Online Japanese Language classes for 10 hours per week from July 2023 to January 2024.

Internship in Japan will be for a period of two weeks from JANUARY 28 to FEB 10, 2024.

The Participants on successful completion of the Internship, are eligible to become Associate Members of our Alumni Society.

Hope you will kindly do the needful. In case you need any further clarification, you may please contact my colleague in ASA Kerala, Mr. Hudson Peter (Mob: 9447169399).



Eagerly await your timely response.

Thanks and regards

Sincerely yours  
Gopakumar S  
President  
ASA Kerala  
Nippon Kerala Centre  
KINFRA Hi-Tech Park  
HMT Colony P.O.  
Kalamassery-683503  
Kerala, India  
<http://www.asakerala.org/>  
asanipponkerala@gmail.com  
+91 75580 81097

---

### 3 attachments

-  **Application Guidelines - Matsue Internship-'23-'24.pdf**  
423K
-  **Matsue Program Flyer - '23-'24.pdf**  
955K
-  **Application form- Matsue Internship-'23-'24.xlsx**  
152K

---

**Dr. Varun G Menon** <varunmenon@scmsgroup.org>

Tue, May 2, 2023 at 11:09 AM

To: Asa Kerala <asanipponkerala@gmail.com>

Cc: Gopakumar S <meenagopan1984@gmail.com>, T J Thomas <tjthomas.6125@gmail.com>, Subhash T J <tjsubhash@gmail.com>, Beby Mathew <bebymathew@gmail.com>, MADHU S NAIR <cmd@cochinshipyard.com>, Edgar Morris <edgarf Morris@gmail.com>, Hudson Peter <hudsonpeter4@gmail.com>

Dear Sir,

Thank you very much for the information. We will shortlist the students and update you at the earliest.  
Thank you once again for the collaboration with SCMS.

Regards,  
Varun

[Quoted text hidden]

--

**Thanks and Regards,**

**Dr. Varun G Menon**, *Senior Member IEEE*  
Professor and Head

Department of Computer Science and Engineering  
International Collaborations -in charge  
SCMS School of Engineering and Technology  
SCMS Group of Educational Institutions  
Kerala, India - 683 576, Mob: +91 8714504684

-----  
Associate Editor - Physical Communications Journal, Elsevier  
Series Editor - IEEE Transactions on Intelligent Transportation Systems  
Series Editor - IEEE Communications Standards Magazine  
Technical Editor - Computer Communications Journal, Elsevier  
Associate Editor - Alexandria Engineering Journal, Elsevier  
Associate Editor - IET Networks  
Editorial Member - IEEE Future Directions Newsletter

---

**Dr. Varun G Menon** <varunmenon@scmsgroup.org>  
To: PRINCIPAL SSET <principalsset@scmsgroup.org>

Tue, May 2, 2023 at 11:22 AM

Ma'am,  
For your information.  
[Quoted text hidden]

---

**PRINCIPAL SSET** <principalsset@scmsgroup.org>  
To: "Dr. Varun G Menon" <varunmenon@scmsgroup.org>

Tue, May 2, 2023 at 11:23 AM

Noted  
Regards,

---  
**Dr. Anitha G. Pillai** |  
Principal



**SCMS**

School of Engineering & Technology

SCMS School of Engineering & Technology (SSET)  
Vidya Nagar, Palissery, Karukutty - 683 576, Kerala, India.  
Tel: 91-484-2882901  
Mob: 9497775295 | 7034780073  
e-mail: [principalsset@scmsgroup.org](mailto:principalsset@scmsgroup.org)  
[anithagpillai@scmsgroup.org](mailto:anithagpillai@scmsgroup.org)

[Quoted text hidden]

---

**Mail Delivery Subsystem** <mailer-daemon@googlemail.com>  
To: varunmenon@scmsgroup.org

Wed, May 3, 2023 at 1:54 PM



## Delivery incomplete

There was a temporary problem delivering your message to **cmd@cochinshipyard.com**. Gmail will retry for 45 more hours. You'll be notified if the delivery fails permanently.

[LEARN MORE](#)

The response was:

The recipient server did not accept our requests to connect. Learn more at <https://support.google.com/mail/answer/7720> [cochinshipyard.com 162.215.226.3: timed out]

Final-Recipient: rfc822; [cmd@cochinshipyard.com](mailto:cmd@cochinshipyard.com)

Action: delayed

Status: 4.4.1

Diagnostic-Code: smtp; The recipient server did not accept our requests to connect. Learn more at <https://support.google.com/mail/answer/7720>

[cochinshipyard.com 162.215.226.3: timed out]

Last-Attempt-Date: Wed, 03 May 2023 01:24:37 -0700 (PDT)

Will-Retry-Until: Thu, 04 May 2023 22:39:58 -0700 (PDT)

----- Forwarded message -----

From: "Dr. Varun G Menon" <varunmenon@scmsgroup.org>

To: Asa Kerala <asanipponkerala@gmail.com>

Cc: Gopakumar S <meenagopan1984@gmail.com>, T J Thomas <tjthomas.6125@gmail.com>, Subhash T J <tjsubhash@gmail.com>, Beby Mathew <bebymathew@gmail.com>, MADHU S NAIR <cmd@cochinshipyard.com>, Edgar Morris <edgarfmorris@gmail.com>, Hudson Peter <hudsonpeter4@gmail.com>

Bcc:

Date: Tue, 2 May 2023 11:09:46 +0530

Subject: Re: Invitation of Applications from SCMS for MATSUE INTERNSHIP PROGRAM - JAN 28 - FEB 10 , 2024 in Matsue city, JAPAN - Deadline: MAY 31, 2023

----- Message truncated -----

---

**Mail Delivery Subsystem** <mailer-daemon@googlemail.com>

Thu, May 4, 2023 at 3:26 PM

To: varunmenon@scmsgroup.org



## Delivery incomplete

There was a temporary problem delivering your message to [cmd@cochinshipyard.com](mailto:cmd@cochinshipyard.com). Gmail will retry for 19 more hours. You'll be notified if the delivery fails permanently.

[LEARN MORE](#)

The response was:

The recipient server did not accept our requests to connect. Learn more at <https://support.google.com/mail/answer/7720> [cochinshipyard.com 162.215.226.3: timed out]

Final-Recipient: rfc822; [cmd@cochinshipyard.com](mailto:cmd@cochinshipyard.com)

Action: delayed

Status: 4.4.1



Diagnostic-Code: smtp; The recipient server did not accept our requests to connect. Learn more at <https://support.google.com/mail/answer/7720>

[[cochinshipyard.com](https://support.google.com/mail/answer/7720) 162.215.226.3: timed out]

Last-Attempt-Date: Thu, 04 May 2023 02:56:49 -0700 (PDT)

Will-Retry-Until: Thu, 04 May 2023 22:39:58 -0700 (PDT)

----- Forwarded message -----

From: "Dr. Varun G Menon" <varunmenon@scmsgroup.org>

To: Asa Kerala <asanipponkerala@gmail.com>

Cc: Gopakumar S <meenagopan1984@gmail.com>, T J Thomas <tjthomas.6125@gmail.com>, Subhash T J <tjsubhash@gmail.com>, Beby Mathew <bebymathew@gmail.com>, MADHU S NAIR <cmd@cochinshipyard.com>, Edgar Morris <edgarfmorris@gmail.com>, Hudson Peter <hudsonpeter4@gmail.com>

Bcc:

Date: Tue, 2 May 2023 11:09:46 +0530

Subject: Re: Invitation of Applications from SCMS for MATSUE INTERNSHIP PROGRAM - JAN 28 - FEB 10 , 2024 in Matsue city, JAPAN - Deadline: MAY 31, 2023

----- Message truncated -----

**Mail Delivery Subsystem** <mailer-daemon@googlemail.com>

Fri, May 5, 2023 at 12:28 PM

To: varunmenon@scmsgroup.org



## Message not delivered

There was a problem delivering your message to **cmd@cochinshipyard.com**. See the technical details below.

[LEARN MORE](#)

The response was:

The recipient server did not accept our requests to connect. Learn more at <https://support.google.com/mail/answer/7720> [[cochinshipyard.com](https://support.google.com/mail/answer/7720) 162.215.226.3: timed out]

Final-Recipient: rfc822; [cmd@cochinshipyard.com](mailto:cmd@cochinshipyard.com)

Action: failed

Status: 4.4.1

Diagnostic-Code: smtp; The recipient server did not accept our requests to connect. Learn more at <https://support.google.com/mail/answer/7720>

[[cochinshipyard.com](https://support.google.com/mail/answer/7720) 162.215.226.3: timed out]

Last-Attempt-Date: Thu, 04 May 2023 23:58:32 -0700 (PDT)

----- Forwarded message -----

From: "Dr. Varun G Menon" <varunmenon@scmsgroup.org>

To: Asa Kerala <asanipponkerala@gmail.com>

Cc: Gopakumar S <meenagopan1984@gmail.com>, T J Thomas <tjthomas.6125@gmail.com>, Subhash T J <tjsubhash@gmail.com>, Beby Mathew <bebymathew@gmail.com>, MADHU S NAIR <cmd@cochinshipyard.com>, Edgar Morris <edgarfmorris@gmail.com>, Hudson Peter <hudsonpeter4@gmail.com>

Bcc:

Date: Tue, 2 May 2023 11:09:46 +0530

Subject: Re: Invitation of Applications from SCMS for MATSUE INTERNSHIP PROGRAM - JAN 28 - FEB 10 , 2024 in

Matsue city, JAPAN - Deadline: MAY 31, 2023

----- Message truncated -----

**Dr. Varun G Menon** <varunmenon@scmsgroup.org>

Fri, May 26, 2023 at 1:20 PM

To: Asa Kerala <asanipponkerala@gmail.com>

Cc: Gopakumar S <meenagopan1984@gmail.com>, T J Thomas <tjthomas.6125@gmail.com>, Subhash T J <tjsubhash@gmail.com>, Beby Mathew <bebymathew@gmail.com>, MADHU S NAIR <cmd@cochinshipyard.com>, Edgar Morris <edgarfmorris@gmail.com>, Hudson Peter <hudsonpeter4@gmail.com>, PRINCIPAL SSET <principalsset@scmsgroup.org>

Dear Sir,

Please find the attached application forms and certificates of the six shortlisted students from SCMS School of Engineering and Technology for the Matsue internship program. Mr. Alan Varghese has applied for the passport today. The passport copies of all others have been attached. Please let me know any further information received.

1	Meenakshy R Nambiar	Semester 6 (CSE)
2	Alan Varghese Paul	Semester 6 (CSE)
3	Gasteena Laurianda Pess	Semester 4 (CSE)
4	Akash T S	Semester 4 (CSE)
5	Claris Isidore	Semester 4 (CSE)
6	Aina Arun	Semester 4 (CSE)

Google Drive Link of documents

 [SCMS\\_Students Application Forms.rar](#)

Thanks and Regards,  
Varun

On Fri, Apr 28, 2023 at 10:55 PM Asa Kerala <asanipponkerala@gmail.com> wrote:

[Quoted text hidden]

[Quoted text hidden]

**Mail Delivery Subsystem** <mailer-daemon@googlemail.com>

Sat, May 27, 2023 at 1:30 PM

To: varunmenon@scmsgroup.org



## Delivery incomplete

There was a temporary problem delivering your message to **cmd@cochinshipyard.com**. Gmail will retry for 47 more hours. You'll be notified if the delivery fails permanently.

[LEARN MORE](#)

The response was:

The recipient server did not accept our requests to connect. Learn more at <https://support.google.com/mail/answer/7720> [cochinshipyard.com 162.215.226.3: timed out]

Final-Recipient: rfc822; [cmd@cochinshipyard.com](mailto:cmd@cochinshipyard.com)

Action: delayed

Status: 4.4.1

Diagnostic-Code: smtp; The recipient server did not accept our requests to connect. Learn more at <https://support.google.com/mail/answer/7720>

[[cochinshipyard.com](mailto:cmd@cochinshipyard.com) 162.215.226.3: timed out]

Last-Attempt-Date: Sat, 27 May 2023 01:00:19 -0700 (PDT)

Will-Retry-Until: Mon, 29 May 2023 00:50:46 -0700 (PDT)

----- Forwarded message -----

From: "Dr. Varun G Menon" <[varunmenon@scmsgroup.org](mailto:varunmenon@scmsgroup.org)>

To: Asa Kerala <[asanipponkerala@gmail.com](mailto:asanipponkerala@gmail.com)>

Cc: Gopakumar S <[meenagopan1984@gmail.com](mailto:meenagopan1984@gmail.com)>, T J Thomas <[tjthomas.6125@gmail.com](mailto:tjthomas.6125@gmail.com)>, Subhash T J <[tjsubhash@gmail.com](mailto:tjsubhash@gmail.com)>, Beby Mathew <[bebymathew@gmail.com](mailto:bebymathew@gmail.com)>, MADHU S NAIR <[cmd@cochinshipyard.com](mailto:cmd@cochinshipyard.com)>, Edgar Morris <[edgarfmorris@gmail.com](mailto:edgarfmorris@gmail.com)>, Hudson Peter <[HUDSONPETER4@gmail.com](mailto:HUDSONPETER4@gmail.com)>, PRINCIPAL SSET <[principalssset@scmsgroup.org](mailto:principalssset@scmsgroup.org)>

Bcc:

Date: Fri, 26 May 2023 13:20:34 +0530

Subject: Re: Invitation of Applications from SCMS for MATSUE INTERNSHIP PROGRAM - JAN 28 - FEB 10 , 2024 in Matsue city, JAPAN - Deadline: MAY 31, 2023

----- Message truncated -----

**Mail Delivery Subsystem** <[mailer-daemon@googlemail.com](mailto:mailer-daemon@googlemail.com)>

Sun, May 28, 2023 at 3:49 PM

To: [varunmenon@scmsgroup.org](mailto:varunmenon@scmsgroup.org)



## Delivery incomplete

There was a temporary problem delivering your message to [cmd@cochinshipyard.com](mailto:cmd@cochinshipyard.com). Gmail will retry for 21 more hours. You'll be notified if the delivery fails permanently.

[LEARN MORE](#)

The response was:

The recipient server did not accept our requests to connect. Learn more at <https://support.google.com/mail/answer/7720> [[cochinshipyard.com](mailto:cmd@cochinshipyard.com) 162.215.226.3: timed out]

Final-Recipient: rfc822; [cmd@cochinshipyard.com](mailto:cmd@cochinshipyard.com)

Action: delayed

Status: 4.4.1

Diagnostic-Code: smtp; The recipient server did not accept our requests to connect. Learn more at <https://support.google.com/mail/answer/7720>

[[cochinshipyard.com](mailto:cmd@cochinshipyard.com) 162.215.226.3: timed out]

Last-Attempt-Date: Sun, 28 May 2023 03:19:23 -0700 (PDT)

Will-Retry-Until: Mon, 29 May 2023 00:50:46 -0700 (PDT)

----- Forwarded message -----

From: "Dr. Varun G Menon" <[varunmenon@scmsgroup.org](mailto:varunmenon@scmsgroup.org)>

To: Asa Kerala <[asanipponkerala@gmail.com](mailto:asanipponkerala@gmail.com)>

Cc: Gopakumar S <[meenagopan1984@gmail.com](mailto:meenagopan1984@gmail.com)>, T J Thomas <[tjthomas.6125@gmail.com](mailto:tjthomas.6125@gmail.com)>, Subhash T J

<tjsubhash@gmail.com>, Beby Mathew <bebymathew@gmail.com>, MADHU S NAIR <cmd@cochinshipyard.com>, Edgar Morris <edgarfmorris@gmail.com>, Hudson Peter <hudsonpeter4@gmail.com>, PRINCIPAL SSET <principalsset@scmsgroup.org>

Bcc:

Date: Fri, 26 May 2023 13:20:34 +0530

Subject: Re: Invitation of Applications from SCMS for MATSUE INTERNSHIP PROGRAM - JAN 28 - FEB 10 , 2024 in Matsue city, JAPAN - Deadline: MAY 31, 2023

----- Message truncated -----

---

**Mail Delivery Subsystem** <mailer-daemon@googlemail.com>

Mon, May 29, 2023 at 1:27 PM

To: varunmenon@scmsgroup.org



## Message not delivered

There was a problem delivering your message to **cmd@cochinshipyard.com**. See the technical details below.

[LEARN MORE](#)

The response was:

The recipient server did not accept our requests to connect. Learn more at <https://support.google.com/mail/answer/7720> [cochinshipyard.com 162.215.226.3: timed out]

Final-Recipient: rfc822; [cmd@cochinshipyard.com](mailto:cmd@cochinshipyard.com)

Action: failed

Status: 4.4.1

Diagnostic-Code: smtp; The recipient server did not accept our requests to connect. Learn more at <https://support.google.com/mail/answer/7720>

[cochinshipyard.com 162.215.226.3: timed out]

Last-Attempt-Date: Mon, 29 May 2023 00:57:14 -0700 (PDT)

----- Forwarded message -----

From: "Dr. Varun G Menon" <varunmenon@scmsgroup.org>

To: Asa Kerala <asanipponkerala@gmail.com>

Cc: Gopakumar S <meenagopan1984@gmail.com>, T J Thomas <tjthomas.6125@gmail.com>, Subhash T J <tjsubhash@gmail.com>, Beby Mathew <bebymathew@gmail.com>, MADHU S NAIR <cmd@cochinshipyard.com>, Edgar Morris <edgarfmorris@gmail.com>, Hudson Peter <hudsonpeter4@gmail.com>, PRINCIPAL SSET <principalsset@scmsgroup.org>

Bcc:

Date: Fri, 26 May 2023 13:20:34 +0530

Subject: Re: Invitation of Applications from SCMS for MATSUE INTERNSHIP PROGRAM - JAN 28 - FEB 10 , 2024 in Matsue city, JAPAN - Deadline: MAY 31, 2023

----- Message truncated -----

---

**Dr. Varun G Menon** <varunmenon@scmsgroup.org>

Mon, Jun 5, 2023 at 5:43 PM

To: HOD Computer Science Engineering Department <hodcssset@scmsgroup.org>

----- Forwarded message -----

From: **Dr. Varun G Menon** <varunmenon@scmsgroup.org>

Date: Fri, May 26, 2023 at 1:20 PM

Subject: Re: Invitation of Applications from SCMS for MATSUE INTERNSHIP PROGRAM - JAN 28 - FEB 10 , 2024 in Matsue city, JAPAN - Deadline: MAY 31, 2023

To: Asa Kerala <asanipponkerala@gmail.com>

[Quoted text hidden]

[Quoted text hidden]

[Quoted text hidden]

Thanks and Regards,

[Quoted text hidden]

[Quoted text hidden]

---

**Dr. Varun G Menon** <varunmenon@scmsgroup.org>

Sat, Jul 29, 2023 at 10:48 AM

To: Asa Kerala <asanipponkerala@gmail.com>

Cc: Gopakumar S <meenagopan1984@gmail.com>, T J Thomas <tjthomas.6125@gmail.com>, Subhash T J <tjsubhash@gmail.com>, Beby Mathew <bebymathew@gmail.com>, MADHU S NAIR <cmd@cochinshipyard.com>, Edgar Morris <edgarfmorris@gmail.com>, Hudson Peter <hudsonpeter4@gmail.com>, MEENAKSHY R NAMBIAR <meenakshynambiar12@gmail.com>, Alan Varghese Paul <alanvarghesepaul29@gmail.com>

Dear Sir,

I hope everything is going well. We just received the academic calendar for the semester from APJ Abdul Kalam Kerala Technological University. The commencement date of the end semester university examination for B.Tech S7 (Ms. Meenakshy and Mr. Alan) is given as 20th January. Kindly do the needful, and also, if we need to inform the same to Matsue authorities. Attaching the calendar for your perusal.

Thank you

On Fri, Apr 28, 2023 at 10:55 PM Asa Kerala <asanipponkerala@gmail.com> wrote:

[Quoted text hidden]

[Quoted text hidden]

---

 **BTech Academic Calendar.pdf**  
257K

---

**Dr. Varun G Menon** <varunmenon@scmsgroup.org>

Sat, Jul 29, 2023 at 11:07 AM

To: PRINCIPAL SSET <principalsset@scmsgroup.org>

Ma'am,

For your information. I forgot to keep a cc to you.

Thank you

----- Forwarded message -----

From: **Dr. Varun G Menon** <varunmenon@scmsgroup.org>

Date: Sat, Jul 29, 2023 at 10:48 AM

Subject: Re: Invitation of Applications from SCMS for MATSUE INTERNSHIP PROGRAM - JAN 28 - FEB 10 , 2024 in Matsue city, JAPAN - Deadline: MAY 31, 2023

To: Asa Kerala <asanipponkerala@gmail.com>

[Quoted text hidden]

[Quoted text hidden]

[Quoted text hidden]

---

 **BTech Academic Calendar.pdf**  
257K

---

**Mail Delivery Subsystem** <mailer-daemon@googlemail.com>

Sun, Jul 30, 2023 at 2:03 PM

To: varunmenon@scmsgroup.org



## Delivery incomplete

There was a temporary problem delivering your message to **cmd@cochinshipyard.com**. Gmail will retry for 44 more hours. You'll be notified if the delivery fails permanently.

[LEARN MORE](#)

The response was:

The recipient server did not accept our requests to connect. Learn more at <https://support.google.com/mail/answer/7720> [cochinshipyard.com 162.215.226.3: timed out]

Final-Recipient: rfc822; [cmd@cochinshipyard.com](mailto:cmd@cochinshipyard.com)

Action: delayed

Status: 4.4.1

Diagnostic-Code: smtp; The recipient server did not accept our requests to connect. Learn more at <https://support.google.com/mail/answer/7720>

[cochinshipyard.com 162.215.226.3: timed out]

Last-Attempt-Date: Sun, 30 Jul 2023 01:33:07 -0700 (PDT)

Will-Retry-Until: Mon, 31 Jul 2023 22:18:45 -0700 (PDT)

----- Forwarded message -----

From: "Dr. Varun G Menon" <varunmenon@scmsgroup.org>

To: Asa Kerala <asanipponkerala@gmail.com>

Cc: Gopakumar S <meenagopan1984@gmail.com>, T J Thomas <tjthomas.6125@gmail.com>, Subhash T J <tjsubhash@gmail.com>, Beby Mathew <bebymathew@gmail.com>, MADHU S NAIR <cmd@cochinshipyard.com>, Edgar Morris <edgarfmorris@gmail.com>, Hudson Peter <hudsonpeter4@gmail.com>, MEENAKSHY R NAMBIAR <meenakshynambiar12@gmail.com>, Alan Varghese Paul <alanvarghesepaul29@gmail.com>

Bcc:

Date: Sat, 29 Jul 2023 10:48:32 +0530

Subject: Re: Invitation of Applications from SCMS for MATSUE INTERNSHIP PROGRAM - JAN 28 - FEB 10 , 2024 in Matsue city, JAPAN - Deadline: MAY 31, 2023

----- Message truncated -----

Mail Delivery Subsystem <mailer-daemon@googlemail.com>

To: varunmenon@scmsgroup.org

Mon, Jul 31, 2023 at 3:17 PM



## Delivery incomplete

There was a temporary problem delivering your message to **cmd@cochinshipyard.com**. Gmail will retry for 19 more hours. You'll be notified if the delivery fails permanently.

[LEARN MORE](#)

The response was:

The recipient server did not accept our requests to connect. Learn more at <https://support.google.com/mail/answer/7720> [cochinshipyard.com 162.215.226.3: timed out]

Final-Recipient: rfc822; [cmd@cochinshipyard.com](mailto:cmd@cochinshipyard.com)

Action: delayed

Status: 4.4.1

Diagnostic-Code: smtp; The recipient server did not accept our requests to connect. Learn more at

<https://support.google.com/mail/answer/7720>

[cochinshipyard.com 162.215.226.3: timed out]

Last-Attempt-Date: Mon, 31 Jul 2023 02:47:47 -0700 (PDT)

Will-Retry-Until: Mon, 31 Jul 2023 22:18:45 -0700 (PDT)

----- Forwarded message -----

From: "Dr. Varun G Menon" <[varunmenon@scmsgroup.org](mailto:varunmenon@scmsgroup.org)>

To: Asa Kerala <[asanipponkerala@gmail.com](mailto:asanipponkerala@gmail.com)>

Cc: Gopakumar S <[meenagopan1984@gmail.com](mailto:meenagopan1984@gmail.com)>, T J Thomas <[tjthomas.6125@gmail.com](mailto:tjthomas.6125@gmail.com)>, Subhash T J <[tjsubhash@gmail.com](mailto:tjsubhash@gmail.com)>, Beby Mathew <[bebymathew@gmail.com](mailto:bebymathew@gmail.com)>, MADHU S NAIR <[cmd@cochinshipyard.com](mailto:cmd@cochinshipyard.com)>, Edgar Morris <[edgarfmorris@gmail.com](mailto:edgarfmorris@gmail.com)>, Hudson Peter <[HUDSONPETER4@gmail.com](mailto:HUDSONPETER4@gmail.com)>, MEENAKSHY R NAMBIAR <[meenakshynambiar12@gmail.com](mailto:meenakshynambiar12@gmail.com)>, Alan Varghese Paul <[alanvarghesepaul29@gmail.com](mailto:alanvarghesepaul29@gmail.com)>

Bcc:

Date: Sat, 29 Jul 2023 10:48:32 +0530

Subject: Re: Invitation of Applications from SCMS for MATSUE INTERNSHIP PROGRAM - JAN 28 - FEB 10 , 2024 in Matsue city, JAPAN - Deadline: MAY 31, 2023

----- Message truncated -----

**Mail Delivery Subsystem** <[mailer-daemon@googlemail.com](mailto:mailer-daemon@googlemail.com)>

Tue, Aug 1, 2023 at 11:32 AM

To: [varunmenon@scmsgroup.org](mailto:varunmenon@scmsgroup.org)



## Message not delivered

There was a problem delivering your message to [cmd@cochinshipyard.com](mailto:cmd@cochinshipyard.com). See the technical details below.

[LEARN MORE](#)

The response was:

The recipient server did not accept our requests to connect. Learn more at <https://support.google.com/mail/answer/7720> [cochinshipyard.com 162.215.226.3: timed out]

Final-Recipient: rfc822; [cmd@cochinshipyard.com](mailto:cmd@cochinshipyard.com)

Action: failed

Status: 4.4.1

Diagnostic-Code: smtp; The recipient server did not accept our requests to connect. Learn more at

<https://support.google.com/mail/answer/7720>

[[cochinshipyard.com](mailto:cochinshipyard.com) 162.215.226.3: timed out]

Last-Attempt-Date: Mon, 31 Jul 2023 23:02:05 -0700 (PDT)

----- Forwarded message -----

From: "Dr. Varun G Menon" <[varunmenon@scmsgroup.org](mailto:varunmenon@scmsgroup.org)>

To: Asa Kerala <[asanipponkerala@gmail.com](mailto:asanipponkerala@gmail.com)>

Cc: Gopakumar S <[meenagopan1984@gmail.com](mailto:meenagopan1984@gmail.com)>, T J Thomas <[tjthomas.6125@gmail.com](mailto:tjthomas.6125@gmail.com)>, Subhash T J <[tjsubhash@gmail.com](mailto:tjsubhash@gmail.com)>, Beby Mathew <[bebymathew@gmail.com](mailto:bebymathew@gmail.com)>, MADHU S NAIR <[cmd@cochinshipyard.com](mailto:cmd@cochinshipyard.com)>, Edgar Morris <[edgarfmorris@gmail.com](mailto:edgarfmorris@gmail.com)>, Hudson Peter <[hudsonpeter4@gmail.com](mailto:hudsonpeter4@gmail.com)>, MEENAKSHY R NAMBIAR <[meenakshynambiar12@gmail.com](mailto:meenakshynambiar12@gmail.com)>, Alan Varghese Paul <[alanvarghesepaul29@gmail.com](mailto:alanvarghesepaul29@gmail.com)>

Bcc:

Date: Sat, 29 Jul 2023 10:48:32 +0530

Subject: Re: Invitation of Applications from SCMS for MATSUE INTERNSHIP PROGRAM - JAN 28 - FEB 10 , 2024 in Matsue city, JAPAN - Deadline: MAY 31, 2023

----- Message truncated -----

---

**Dr. Varun G Menon** <[varunmenon@scmsgroup.org](mailto:varunmenon@scmsgroup.org)>

Sat, Aug 19, 2023 at 12:25 PM

To: Asa Kerala <[asanipponkerala@gmail.com](mailto:asanipponkerala@gmail.com)>

Cc: Gopakumar S <[meenagopan1984@gmail.com](mailto:meenagopan1984@gmail.com)>, T J Thomas <[tjthomas.6125@gmail.com](mailto:tjthomas.6125@gmail.com)>, Subhash T J <[tjsubhash@gmail.com](mailto:tjsubhash@gmail.com)>, Beby Mathew <[bebymathew@gmail.com](mailto:bebymathew@gmail.com)>, Edgar Morris <[edgarfmorris@gmail.com](mailto:edgarfmorris@gmail.com)>, Hudson Peter <[hudsonpeter4@gmail.com](mailto:hudsonpeter4@gmail.com)>, MEENAKSHY R NAMBIAR <[meenakshynambiar12@gmail.com](mailto:meenakshynambiar12@gmail.com)>, Alan Varghese Paul <[alanvarghesepaul29@gmail.com](mailto:alanvarghesepaul29@gmail.com)>, PRINCIPAL SSET <[principalsset@scmsgroup.org](mailto:principalsset@scmsgroup.org)>, Sindhya K <[sindhya@scmsgroup.org](mailto:sindhya@scmsgroup.org)>, Arshey M <[arsheym@scmsgroup.org](mailto:arsheym@scmsgroup.org)>

Dear Sir,

I hope you are doing well. Please find the attached final academic calendar published by APJ Abdul Kalam Kerala Technological University. The commencement date of the end-semester university examination for B.Tech S7 (Ms. Meenakshy and Mr. Alan) has been changed to 5th January 2023. So we believe that all the examinations will be over before the commencement date of the Matsue internship. Just keeping you posted.

Regards,

Varun

[Quoted text hidden]



**B. Tech Academic Calendar\_S3\_S5\_S7 ( Odd Semester 2023-24) (1).pdf**

292K





**MEMORANDUM OF UNDERSTANDING (MoU)  
AND ACADEMIC COLLABORATION**

**BETWEEN**

**SCMS GROUP OF EDUCATIONAL INSTITUTIONS, COCHIN, INDIA**

**AND**

**DAFFODIL INTERNATIONAL UNIVERSITY, DHAKA, BANGLADESH**

SCMS Group of Educational Institutions, Cochin, India and Daffodil International University, Dhaka, Bangladesh, aim to establish and develop a close partnership to promote academic and cultural exchanges between the two Institutions through mutual assistance, specially, in the areas of teaching and research.

This Agreement of Co-operation, upon approval of the Vice Chancellor of Daffodil International University and the Vice Chairman of SCMS Group of Educational Institutions will serve as a general framework for institutional co-operation. It will facilitate faculty members to discuss and develop specific programs of co-operation. Each University will designate a liaison officer to co-ordinate the application of this Agreement in the best interest of both Institutions. Co-operative relations shall be carried out through the activities such as:

- **Short Project Internships / Study Tours / Summer Program:** Students from partner universities will agree to participate in Short Project Internships / Study Tours / Summer Program in various research areas. The partner institution will circulate the notices and program plan among students and motivate them to attend the program for capacity building and cross cultural education.
- **Faculty Exchange:** The exchange of academic staff for short duration in order to share expertise and knowledge among staff and students of both institutions.
- **Resources Share:** The acquiescence of access to the Library database, Journal and other online resources for both staff and students of each university.
- **Blended Learning Courses:** Both Partner institutions may arrange blender learning courses/program for the students where students will study specific subjects in their home institution and rest of them will complete in the partner institution
- **Scholarship Opportunity:** Both Institution may arrange scholarship opportunity for meritorious students of partner institution and cooperate accordingly.

The provisions and activities specified in this Agreement are subjected to the availability of funds and the approval of the Authorized Officers of both Institutions. A separate financial agreement to be finalized prior to implementation of the program arrangement.

The Agreement shall take effect from the date of signing and shall be valid for an initial period of 5 (five) years. Any amendment and/or modification of this Agreement require the written approval of the Vice Chancellor of Daffodil International University and the Vice Chairman of SCMS Group of Educational Institutions and shall be appended hereto. Neither University shall take action relative to this Agreement without consultation with the partner in this Agreement.

Signed on behalf of  
**SCMS Group of Educational Institutions**  
India

Signed on behalf of  
**Daffodil International University**  
Bangladesh



**Prof. Pramod P Thevanoor**  
Vice Chairman  
SCMS Group of Educational Institutions

Date: 25/07/2018



**Prof. Dr. Yousuf Mahbubul Islam**  
Vice Chancellor  
Daffodil International University

Date: 25/07/2018



# SCMS

# GROUP OF EDUCATIONAL INSTITUTIONS

SCMS CAMPUS, PRATHAP NAGAR, MUTTOM, ALUVA, COCHIN - 683 106, INDIA  
Phone: 91-484-2628000, 3231976 • Email: scms@scmsgroup.org • Website: www.scmsgroup.org

SSET/155/19/0638

14.05.2019

Mr. Ramit Arko  
Student – ID 181-33-4450  
Electrical and Electronics Engineering  
Daffodil International University  
Dattapara, Ashulia  
Savar, Dhaka.

Dear Mr. Ramit Arko,

We have pleasure to invite you to our campus to participate in the Internship / Study Tour program for International students offered by Centre for Robotics, SCMS School of Engineering and Technology.

The objective of this programme is to impart knowledge in the field of robotics to students from all streams of engineering and help them build prototypes and make their innovative ideas come to reality. The program duration is two weeks - June 16 – July 1, 2019.

We look forward to your visit to our campus and we wish you all the best.

Yours sincerely,

PRAMOD P. THEVANNOOR  
VICE CHAIRMAN – SCMS GROUP



#### MEMBER INSTITUTIONS

- ▶ SCMS COCHIN SCHOOL OF BUSINESS
- ▶ SCMS School of Technology and Management
- ▶ SCMS School of Engineering and Technology
- ▶ SCMS School of Architecture
- ▶ SCMS College of Polytechnics
- ▶ SCMS Institute for Bioscience and Biotechnology
- ▶ SCMS Water Institute
- ▶ SCMS Centre for Research, Consultancy and Training



# SCMS

## GROUP OF EDUCATIONAL INSTITUTIONS

SCMS CAMPUS, PRATHAP NAGAR, MUTTOM, ALUVA, COCHIN - 683 106, INDIA  
Phone: 91-484-2628000, 3231976 • Email: scms@scmsgroup.org • Website: www.scmsgroup.org

SSET/155/19/0638

14.05.2019

Mr.Md. Sazzad Sarker (Passport No. EA0142391)

Student – ID 181-33-4594

Electrical and Electronics Engineering

Daffodil International University

Dattapara, Ashulia

Savar, Dhaka.

Dear Mr. Md. Sazzad Sarker,

We have pleasure to invite you to our campus to participate in the Internship / Study Tour program for International students offered by Centre for Robotics, SCMS School of Engineering and Technology.

The objective of this programme is to impart knowledge in the field of robotics to students from all streams of engineering and help them build prototypes and make their innovative ideas come to reality. The program duration is two weeks - June 16 – July 1, 2019.

We look forward to your visit to our campus and we wish you all the best.

Yours sincerely,

PRAMOD P.THEVANNOOR  
VICE CHAIRMAN – SCMS GROUP



#### MEMBER INSTITUTIONS

- ▶ SCMS COCHIN SCHOOL OF BUSINESS
- ▶ SCMS School of Technology and Management
- ▶ SCMS School of Engineering and Technology
- ▶ SCMS School of Architecture
- ▶ SCMS College of Polytechnics
- ▶ SCMS Institute for Bioscience and Biotechnology
- ▶ SCMS Water Institute
- ▶ SCMS Centre for Research, Consultancy and Training



# SCMS

# GROUP OF EDUCATIONAL INSTITUTIONS

SCMS CAMPUS, PRATHAP NAGAR, MUTTOM, ALUVA, COCHIN - 683 106, INDIA  
Phone: 91-484-2628000, 3231976 • Email: [scms@scmsgroup.org](mailto:scms@scmsgroup.org) • Website: [www.scmsgroup.org](http://www.scmsgroup.org)

SSET/155/19/0638

14.05.2019

Mr.M.Atiq Faisal Rafi (Passport No. BY0667816)

Student – ID 172-15-10028

Computer Science and Engineering

**Daffodil International University**

Dattapara, Ashulia

Savar, Dhaka.

Dear Mr. Atiq Faisal Rafi,

We have pleasure to invite you to our campus to participate in the Internship / Study Tour program for International students offered by Centre for Robotics, **SCMS School of Engineering and Technology**.

The objective of this programme is to impart knowledge in the field of robotics to students from all streams of engineering and help them build prototypes and make their innovative ideas come to reality. The program duration is two weeks - **June 16 – July 1, 2019**.

We look forward to your visit to our campus and we wish you all the best.

Yours sincerely,

PRAMOD P.THEVANNOOR  
VICE CHAIRMAN – SCMS GROUP



#### MEMBER INSTITUTIONS

- ▶ SCMS COCHIN SCHOOL OF BUSINESS
- ▶ SCMS School of Technology and Management
- ▶ SCMS School of Engineering and Technology
- ▶ SCMS School of Architecture
- ▶ SCMS College of Polytechnics
- ▶ SCMS Institute for Bioscience and Biotechnology
- ▶ SCMS Water Institute
- ▶ SCMS Centre for Research, Consultancy and Training



# SCMS

# GROUP OF EDUCATIONAL INSTITUTIONS

SCMS CAMPUS, PRATHAP NAGAR, MUTTOM, ALUVA, COCHIN - 683 106, INDIA  
Phone: 91-484-2628000, 3231976 • Email: scms@scmsgroup.org • Website: www.scmsgroup.org

SSET/155/19/0638

14.05.2019

Mr. Nimai Chandra Das (Passport No. EA0270621)  
Student – ID 143-33-2265  
Electrical and Electronics Engineering  
Daffodil International University  
Dattapara, Ashulia  
Savar, Dhaka.

Dear Mr. Nimai Chandra Das,

We have pleasure to invite you to our campus to participate in the Internship / Study Tour program for International students offered by Centre for Robotics, SCMS School of Engineering and Technology.

The objective of this programme is to impart knowledge in the field of robotics to students from all streams of engineering and help them build prototypes and make their innovative ideas come to reality. The program duration is two weeks - June 16 – July 1, 2019.

We look forward to your visit to our campus and we wish you all the best.

Yours sincerely,

PRAMOD P. THEVANNOOR  
VICE CHAIRMAN – SCMS GROUP



#### MEMBER INSTITUTIONS

- ▶ SCMS COCHIN SCHOOL OF BUSINESS
- ▶ SCMS School of Technology and Management
- ▶ SCMS School of Engineering and Technology
- ▶ SCMS School of Architecture
- ▶ SCMS College of Polytechnics
- ▶ SCMS Institute for Bioscience and Biotechnology
- ▶ SCMS Water Institute
- ▶ SCMS Centre for Research, Consultancy and Training



# SCMS

# GROUP OF EDUCATIONAL INSTITUTIONS

SCMS CAMPUS, PRATHAP NAGAR, MUTTOM, ALUVA, COCHIN - 683 106, INDIA  
Phone: 91-484-2628000, 3231976 • Email: scms@scmsgroup.org • Website: www.scmsgroup.org

SSET/155/19/0639

14.05.2019

Mr. Khandker M. Qaiduzzaman  
Lecturer  
Department of Software Engineering  
**Daffodil International University**  
Dattapara, Ashulia  
Savar, Dhaka.

Dear Mr. Khandker Qaiduzzaman,

We have pleasure to invite you to our campus to engage in sessions for our students and faculty as part of the Exchange Programme between our institutions.

The objective of the association between **SCMS Group of Educational Institutions and Daffodil International University, Dhaka, Bangladesh**, is to establish and develop a close partnership to promote academic and cultural exchanges between the two Institutions through mutual assistance, specially, in the areas of teaching and research.

We look forward to your visit to our campus.

Yours sincerely,

PRAMOD P. THEVANNOOR  
VICE CHAIRMAN – SCMS GROUP



#### MEMBER INSTITUTIONS

- ▶ SCMS COCHIN SCHOOL OF BUSINESS
- ▶ SCMS School of Technology and Management
- ▶ SCMS School of Engineering and Technology
- ▶ SCMS School of Architecture
- ▶ SCMS College of Polytechnics
- ▶ SCMS Institute for Bioscience and Biotechnology
- ▶ SCMS Water Institute
- ▶ SCMS Centre for Research, Consultancy and Training

PROMOTED BY PRATHAP FOUNDATION FOR EDUCATION AND TRAINING



Varun Menon G &lt;varunmenon@scmsgroup.org&gt;

---

## Academic Collaboration with Daffodil International University

50 messages

Dr. Varun G Menon <varunmenon@scmsgroup.org>  
To: morsalin.a@daffodilvarsity.edu.bd

Tue, Jun 19, 2018 at 11:09 AM

Respected Mr. Salahuddin Morsalin

Thank you for your time and consideration. Let me introduce as Dr. Varun G Menon, in charge of International Collaborations at SCMS Group of Educational Institutions, India.

We are interested in having academic collaboration with Daffodil International University. Collaboration could be in the areas of student exchange programs, faculty exchange programs, research collaborations, joint seminars and conferences.

We have a dedicate team of faculty and students working in areas like Robotics, Brain Signal Analysis, Computational fluid dynamics. Water Quality Monitoring and Assessment, Limnology, Water Audit, Environmental Remote Sensing , Android Malware Analysis. Research collaborations in these areas is another possibility.

We have academic collaborations with leading international universities like Vrije University-Brussels, Furtwangen University-Germany, University of Applied Sciences Ravensburg Weingarten- Germany, Shimane University-Japan and more.

**Please let me know if we could discuss and take forward this initiative.**

For your information we are the No 1 ranked private educational institutions in the state. You can find more information about our institutions in [www.scmsgroup.org](http://www.scmsgroup.org) and about out Engineering Institute in [www.scmsgroup.org/sset/](http://www.scmsgroup.org/sset/)

Have a Great Day.

Thanks and Regards,

**Dr. Varun G Menon**

Associate Professor-Computer Science Engineering

Exe. Officer-Corporate Relations & International Collaborations

SCMS School of Engineering and Technology

Kerala, India-683582

Office: +91-484-2450330 Mob: +91-8714504684

Web: <http://www.scmsgroup.org/sset/computer-science-engineering/dr-varun-g-menon>



**SCMS**  
School of Engineering & Technology

---

International Affairs, DIU <int@daffodilvarsity.edu.bd>

Sat, Jun 23, 2018 at 6:42 PM

To: varunmenon@scmsgroup.org

Cc: "Office of the International Affairs, DIU" <mobility@daffodilvarsity.edu.bd>, Scholarship News <scholarship@daffodilvarsity.edu.bd>, "International, DIU" <international@daffodilvarsity.edu.bd>

Dear Dr. Varun G Menon,

Greetings from DIU!

Thanks for your email and showing interest in the academic partnership. Yes, we can Ccollaborate in the areas of student exchange programs, faculty exchange programs, summer school research collaborations, joint seminars and conferences.

I have attached here the sample agreement copy of DIU, Could you please check and fill it with your information. Besides, I have attached here the fact sheet of DIU where you can check our common details and department.



Your CSE, ECE and EEE Department can be a good prospect between both universities. Let us know your observation

Looking forward to hearing from you soon.

- With best regards

**Syed Raihan-UI-Islam**

**Senior Administrative Officer, International Affairs**

**Daffodil International University**

102/1, Shukrabad, Dhanmondi, Dhaka-1207, Bangladesh.

Tel: +88 02 9138234 (Ext: 237) | Mob: +88-01811458865

WhatsApp/Viber/Wechat: +88-01920012744

[Quoted text hidden]

---

## 2 attachments

 **MOU Draft\_Between DIU and Other University (1).doc**  
213K

 **Fact Sheet about Daffodil International University.doc**  
263K

---

**Dr. Varun G Menon** <varunmenon@scmsgroup.org>

Sun, Jun 24, 2018 at 12:05 AM

To: "International Affairs, DIU" <int@daffodilvarsity.edu.bd>

Cc: "Office of the International Affairs, DIU" <mobility@daffodilvarsity.edu.bd>, Scholarship News <scholarship@daffodilvarsity.edu.bd>, "International, DIU" <international@daffodilvarsity.edu.bd>

Dear Mr. Syed Raihan-UI-Islam,

Thank you for the information about Daffodil International University. Will complete the agreement copy and send you at the earliest.

We have 5 active research groups in our Engineering College that include Centre for Robotics, Centre for Cyber Security, Hydrodynamics and Computational Fluid Dynamics, Antennas and Radiation, Centre for Sustainable Water Technology and Management. Students from your University can do summer internships and short term projects with these project groups.

Besides we also have one of the leading Management Institute in India and also Biotechnology Research Centre.

Thank you for the collaboration. Will send you the document soon.

Regards,

**Dr. Varun G Menon**

Associate Professor-Computer Science Engineering

Exe. Officer-Corporate Relations & International Collaborations

SCMS School of Engineering and Technology

Kerala, India-683582

Office: +91-484-2450330 Mob: +91-8714504684

Web: <http://www.scmsgroup.org/sset/computer-science-engineering/dr-varun-g-memon>



**SCMS**  
School of Engineering & Technology

[Quoted text hidden]

---

**International Affairs, DIU** <int@daffodilvarsity.edu.bd>

Sun, Jun 24, 2018 at 12:17 AM

To: "Dr. Varun G Menon" <varunmenon@scmsgroup.org>

Cc: "Office of the International Affairs, DIU" <mobility@daffodilvarsity.edu.bd>, Scholarship News

<scholarship@daffodilvarsity.edu.bd>, "International, DIU" <international@daffodilvarsity.edu.bd>, Emran Hossain <emran@daffodilvarsity.edu.bd>

Dear Dr, Varun

Thank you very much for your quick response.

It would be great if you can share any proposal or program plan with all details, course plan, costing etc of the Summer internships based on Cyber Security and Robotics so that we could check and show t our students for interest.

Hope to receive the agreement and the program proposals soon. Have a great day !

- With best regards

**Syed Raihan-UI-Islam**

**Senior Administrative Officer, International Affairs**

**Daffodil International University**

102/1, Shukrabad, Dhanmondi, Dhaka-1207, Bangladesh.

Tel: **+88 02 9138234 (Ext: 237)** | Mob: **+88-01811458865**

WhatsApp/Viber/Wechat: **+88-01920012744**

[Quoted text hidden]

---

**Dr. Varun G Menon** <varunmenon@scmsgroup.org>

Sun, Jun 24, 2018 at 12:56 AM

To: "International Affairs, DIU" <int@daffodilvarsity.edu.bd>

Cc: "Office of the International Affairs, DIU" <mobility@daffodilvarsity.edu.bd>, Scholarship News

<scholarship@daffodilvarsity.edu.bd>, "International, DIU" <international@daffodilvarsity.edu.bd>, Emran Hossain

<emran@daffodilvarsity.edu.bd>

Dear Mr. Syed Raihan-UI-Islam,

Thank you for the email. Will inform the Professor's in charge of the Cyber Security and Robotics research centers about the program plan.

Will sent you the documents soon.

Have a Great Day.

Thanks and Regards,

**Dr. Varun G Menon**

Associate Professor-Computer Science Engineering

Exe. Officer-Corporate Relations & International Collaborations

SCMS School of Engineering and Technology

Kerala, India-683582

Office: +91-484-2450330 Mob: +91-8714504684

Web: <http://www.scmsgroup.org/sset/computer-science-engineering/dr-varun-g-menon>



**SCMS**  
School of Engineering & Technology

[Quoted text hidden]

---

**Dr. Varun G Menon** <varunmenon@scmsgroup.org>

Mon, Jun 25, 2018 at 3:44 PM

To: "International Affairs, DIU" <int@daffodilvarsity.edu.bd>

Cc: "Office of the International Affairs, DIU" <mobility@daffodilvarsity.edu.bd>, Scholarship News

<scholarship@daffodilvarsity.edu.bd>, "International, DIU" <international@daffodilvarsity.edu.bd>, Emran Hossain

<emran@daffodilvarsity.edu.bd>

Dear Mr. Syed Raihan-UI-Islam,

Thank you for the collaboration with SCMS. I have presented the MoU with the Vice Chairman for approval. Once the approval is obtained, I will send back the approved soft copy of the MoU.

I have discussed about the Short Term Internships for students from DIU at the Centre for Robotics, SCMS with the Director, Robotics Lab. He has promised to send me The Best Plan for DIU students within two days. I will send you the same at the earliest.

Thanks and Regards,

**Dr. Varun G Menon**

Associate Professor-Computer Science Engineering

Exe. Officer-Corporate Relations & International Collaborations

SCMS School of Engineering and Technology

Kerala, India-683582

Office: +91-484-2450330 Mob: +91-8714504684

Web: <http://www.scmsgroup.org/sset/computer-science-engineering/dr-varun-g-menon>



**SCMS**  
School of Engineering & Technology

[Quoted text hidden]

**International Affairs, DIU** <int@daffodilvarsity.edu.bd>

Mon, Jun 25, 2018 at 3:55 PM

To: "Dr. Varun G Menon" <varunmenon@scmsgroup.org>

Cc: "Office of the International Affairs, DIU" <mobility@daffodilvarsity.edu.bd>, Scholarship News

<scholarship@daffodilvarsity.edu.bd>, "International, DIU" <international@daffodilvarsity.edu.bd>, Emran Hossain <emran@daffodilvarsity.edu.bd>

Dear Dr. Varun

Thank you so much for your email and letting us know the update.

- With best regards

**Syed Raihan-UI-Islam**

**Senior Administrative Officer, International Affairs**

**Daffodil International University**

102/1, Shukrabad, Dhanmondi, Dhaka-1207, Bangladesh.

Tel: +88 02 9138234 (Ext: 237) | Mob: +88-01811458865

WhatsApp/Viber/Wechat: +88-01920012744

[Quoted text hidden]

**Dr. Varun G Menon** <varunmenon@scmsgroup.org>

Tue, Jun 26, 2018 at 6:31 PM

To: "International Affairs, DIU" <int@daffodilvarsity.edu.bd>

Cc: "Office of the International Affairs, DIU" <mobility@daffodilvarsity.edu.bd>, Scholarship News

<scholarship@daffodilvarsity.edu.bd>, "International, DIU" <international@daffodilvarsity.edu.bd>, Emran Hossain

<emran@daffodilvarsity.edu.bd>, Pramod <pramod@scmsgroup.org>, Indu Nair <indunair@scmsgroup.org>, "Dr. Praveensal C.J." <praveensal@scmsgroup.org>

Dear Mr. Syed Raihan-UI-Islam,

Thank you for the collaboration with SCMS. Please see the attached MoU draft approved by our Vice Chairman. Please let me know the remaining procedures including the signing of the MoU.

Thanks and Regards,

**Dr. Varun G Menon**

Associate Professor-Computer Science Engineering

Exe. Officer-Corporate Relations & International Collaborations

SCMS School of Engineering and Technology

Kerala, India-683582

Office: +91-484-2450330 Mob: +91-8714504684

Web: <http://www.scmsgroup.org/sset/computer-science-engineering/dr-varun-g-menon>



**SCMS**  
School of Engineering & Technology

[Quoted text hidden]

 **MOU\_SCMS and Daffodil University\_26-6-18.doc**

90K

---

**Dr. Varun G Menon** <varunmenon@scmsgroup.org>  
To: Varun Menon G <varunmenon@scmsgroup.org>

Tue, Jun 26, 2018 at 6:32 PM

[Quoted text hidden]

---

 **MOU\_SCMS and Daffodil University\_26-6-18.doc**  
90K

---

**International Affairs, DIU** <int@daffodilvarsity.edu.bd>  
To: "Dr. Varun G Menon" <varunmenon@scmsgroup.org>

Tue, Jun 26, 2018 at 6:54 PM

Cc: "Office of the International Affairs, DIU" <mobility@daffodilvarsity.edu.bd>, Scholarship News <scholarship@daffodilvarsity.edu.bd>, "International, DIU" <international@daffodilvarsity.edu.bd>, Emran Hossain <emran@daffodilvarsity.edu.bd>, Pramod <pramod@scmsgroup.org>, Indu Nair <indunair@scmsgroup.org>, "Dr. Praveensal C.J." <praveensal@scmsgroup.org>

Dear Dr. Varun

Thank you very much for the agreement final copy. It's fine

May I request you to sign the agreement and send the copies to me either scan copy in my email or 2 original copies in my address given in my email signature

- *With best regards*

**Syed Raihan-UI-Islam**

**Senior Administrative Officer, International Affairs**

**Daffodil International University**

102/1, Shukrabad, Dhanmondi, Dhaka-1207, Bangladesh.

Tel: **+88 02 9138234 (Ext: 237)** | Mob: **+88-01811458865**

WhatsApp/Viber/Wechat: **+88-01920012744**

[Quoted text hidden]

---

**Dr. Varun G Menon** <varunmenon@scmsgroup.org>  
To: "International Affairs, DIU" <int@daffodilvarsity.edu.bd>

Tue, Jun 26, 2018 at 10:08 PM

Cc: "Office of the International Affairs, DIU" <mobility@daffodilvarsity.edu.bd>, Scholarship News <scholarship@daffodilvarsity.edu.bd>, "International, DIU" <international@daffodilvarsity.edu.bd>, Emran Hossain <emran@daffodilvarsity.edu.bd>, Pramod <pramod@scmsgroup.org>, Indu Nair <indunair@scmsgroup.org>, "Dr. Praveensal C.J." <praveensal@scmsgroup.org>

Dear Mr. Syed Raihan-UI-Islam,

Thank you for the collaboration with SCMS. We would like to visit the DIU campus on a favorable date and would like to sign the MoU with the Vice Chancellor at DIU.

We would be more than happy to host the DIU team with Vice Chancellor in our campus in future. Please let me know your thoughts.

Thanks and Regards,

**Dr. Varun G Menon**

Associate Professor-Computer Science Engineering

Exe. Officer-Corporate Relations & International Collaborations

SCMS School of Engineering and Technology

Kerala, India-683582

Office: +91-484-2450330 Mob: +91-8714504684

Web: <http://www.scmsgroup.org/sset/computer-science-engineering/dr-varun-g-menon>



**SCMS**  
School of Engineering & Technology

[Quoted text hidden]

---

**International Affairs, DIU** <int@daffodilvarsity.edu.bd> Tue, Jun 26, 2018 at 10:12 PM  
To: "Dr. Varun G Menon" <varunmenon@scmsgroup.org>  
Cc: "Office of the International Affairs, DIU" <mobility@daffodilvarsity.edu.bd>, Scholarship News <scholarship@daffodilvarsity.edu.bd>, "International, DIU" <international@daffodilvarsity.edu.bd>, Emran Hossain <emran@daffodilvarsity.edu.bd>, Pramod <pramod@scmsgroup.org>, Indu Nair <indunair@scmsgroup.org>, "Dr. Praveensal C.J." <praveensal@scmsgroup.org>

Dear Dr. Varun

That is a good idea. Let us know your possible dates to visit us and sign the agreement between both of the universities.

- With best regards

**Syed Raihan-UI-Islam**

**Senior Administrative Officer, International Affairs**  
**Daffodil International University**

102/1, Shukrabad, Dhanmondi, Dhaka-1207, Bangladesh.  
Tel: **+88 02 9138234 (Ext: 237)** | Mob: **+88-01811458865**  
WhatsApp/Viber/Wechat: **+88-01920012744**

[Quoted text hidden]

---

**Dr. Varun G Menon** <varunmenon@scmsgroup.org> Wed, Jun 27, 2018 at 10:25 AM  
To: "International Affairs, DIU" <int@daffodilvarsity.edu.bd>  
Cc: "Office of the International Affairs, DIU" <mobility@daffodilvarsity.edu.bd>, Scholarship News <scholarship@daffodilvarsity.edu.bd>, "International, DIU" <international@daffodilvarsity.edu.bd>, Emran Hossain <emran@daffodilvarsity.edu.bd>, Pramod <pramod@scmsgroup.org>, Indu Nair <indunair@scmsgroup.org>, "Dr. Praveensal C.J." <praveensal@scmsgroup.org>

Dear Mr. Syed Raihan-UI-Islam,

Thank you for the message. We would like to visit DIU between 10th and 14th July. Please let us know if the date is convenient at your end. Also it would be great if you could send us an Invitation letter which could be produced for the Visa.

Let me know any further details required.

Varun

[Quoted text hidden]

--

[Quoted text hidden]

---

**International Affairs, DIU** <int@daffodilvarsity.edu.bd> Wed, Jun 27, 2018 at 10:37 AM  
To: "Dr. Varun G Menon" <varunmenon@scmsgroup.org>  
Cc: "Office of the International Affairs, DIU" <mobility@daffodilvarsity.edu.bd>, Scholarship News <scholarship@daffodilvarsity.edu.bd>, "International, DIU" <international@daffodilvarsity.edu.bd>, Emran Hossain <emran@daffodilvarsity.edu.bd>, Pramod <pramod@scmsgroup.org>, Indu Nair <indunair@scmsgroup.org>, "Dr. Praveensal C.J." <praveensal@scmsgroup.org>

Dear Dr. Varun

Can we shift it to the next week I mean in between 15 to 20 July?

- With best regards

**Syed Raihan-UI-Islam**

**Senior Administrative Officer, International Affairs**  
**Daffodil International University**

102/1, Shukrabad, Dhanmondi, Dhaka-1207, Bangladesh.  
Tel: **+88 02 9138234 (Ext: 237)** | Mob: **+88-01811458865**  
WhatsApp/Viber/Wechat: **+88-01920012744**

[Quoted text hidden]

---

**Dr. Varun G Menon** <varunmenon@scmsgroup.org> Wed, Jun 27, 2018 at 10:48 AM  
To: "International Affairs, DIU" <int@daffodilvarsity.edu.bd>

Cc: "Office of the International Affairs, DIU" <mobility@daffodilvarsity.edu.bd>, Scholarship News <scholarship@daffodilvarsity.edu.bd>, "International, DIU" <international@daffodilvarsity.edu.bd>, Emran Hossain <emran@daffodilvarsity.edu.bd>, Pramod <pramod@scmsgroup.org>, Indu Nair <indunair@scmsgroup.org>, "Dr. Praveensal C.J." <praveensal@scmsgroup.org>

Dear Mr. Syed Raihan-UI-Islam,

Can we have the visit between July 24 and 27. Our Vice Chairman is traveling on other dates in July.

Please let me know.

Varun

[Quoted text hidden]

[Quoted text hidden]

---

**International Affairs, DIU** <int@daffodilvarsity.edu.bd>

Wed, Jun 27, 2018 at 11:29 AM

To: "Dr. Varun G Menon" <varunmenon@scmsgroup.org>

Cc: "Office of the International Affairs, DIU" <mobility@daffodilvarsity.edu.bd>, Scholarship News

<scholarship@daffodilvarsity.edu.bd>, "International, DIU" <international@daffodilvarsity.edu.bd>, Emran Hossain

<emran@daffodilvarsity.edu.bd>, Pramod <pramod@scmsgroup.org>, Indu Nair <indunair@scmsgroup.org>, "Dr. Praveensal

C.J." <praveensal@scmsgroup.org>, "VC Office-2, DIU" <vcoffice2@daffodilvarsity.edu.bd>

Dear Dr. Varun,

I have discussed with the Office of the Vice Chancellor

We can arrange the MoU Signing Ceremony and discussion session on **25 July 2018** from **3PM to 5PM**

We can also arrange to visit our Permanent Campus and Lunch on the on that day 9AM to 2PM too.

Let us know if the time and date is convenient for your visit

Looking forward to hearing from you.

- *With best regards*

**Syed Raihan-UI-Islam**

**Senior Administrative Officer, International Affairs**

**Daffodil International University**

102/1, Shukrabad, Dhanmondi, Dhaka-1207, Bangladesh.

Tel: **+88 02 9138234 (Ext: 237)** | Mob: **+88-01811458865**

WhatsApp/Viber/Wechat: **+88-01920012744**

[Quoted text hidden]

---

**Dr. Varun G Menon** <varunmenon@scmsgroup.org>

Wed, Jun 27, 2018 at 11:42 AM

To: "International Affairs, DIU" <int@daffodilvarsity.edu.bd>

Cc: "Office of the International Affairs, DIU" <mobility@daffodilvarsity.edu.bd>, Scholarship News

<scholarship@daffodilvarsity.edu.bd>, "International, DIU" <international@daffodilvarsity.edu.bd>, Emran Hossain

<emran@daffodilvarsity.edu.bd>, Pramod <pramod@scmsgroup.org>, Indu Nair <indunair@scmsgroup.org>, "Dr. Praveensal

C.J." <praveensal@scmsgroup.org>, "VC Office-2, DIU" <vcoffice2@daffodilvarsity.edu.bd>

Dear Mr. Syed Raihan-UI-Islam,

Thank you for the information. We will have the visit on 25th July. We will send the details of the members visiting the DIU campus at the earliest.

Regards

[Quoted text hidden]

---

**Dr. Varun G Menon** <varunmenon@scmsgroup.org>

Wed, Jun 27, 2018 at 11:43 AM

To: "International Affairs, DIU" <int@daffodilvarsity.edu.bd>

Cc: "Office of the International Affairs, DIU" <mobility@daffodilvarsity.edu.bd>, Scholarship News

<scholarship@daffodilvarsity.edu.bd>, "International, DIU" <international@daffodilvarsity.edu.bd>, Emran Hossain

<emran@daffodilvarsity.edu.bd>, Pramod <pramod@scmsgroup.org>, Indu Nair <indunair@scmsgroup.org>, "Dr. Praveensal

C.J." <praveensal@scmsgroup.org>, "VC Office-2, DIU" <vcoffice2@daffodilvarsity.edu.bd>

Dear Mr. Syed Raihan-UI-Islam,

Thank you for the information. We will have the visit on 25th July. We will send the details of the members visiting the DIU campus at the earliest.

Regards

[Quoted text hidden]

---

**Dr. Varun G Menon** <varunmenon@scmsgroup.org>

Wed, Jun 27, 2018 at 11:43 AM

To: "International Affairs, DIU" &lt;int@daffodilvarsity.edu.bd&gt;

Cc: "Office of the International Affairs, DIU" &lt;mobility@daffodilvarsity.edu.bd&gt;, Scholarship News &lt;scholarship@daffodilvarsity.edu.bd&gt;, "International, DIU" &lt;international@daffodilvarsity.edu.bd&gt;, Emran Hossain &lt;emran@daffodilvarsity.edu.bd&gt;, Pramod &lt;pramod@scmsgroup.org&gt;, Indu Nair &lt;indunair@scmsgroup.org&gt;, "Dr. Praveensal C.J." &lt;praveensal@scmsgroup.org&gt;, "VC Office-2, DIU" &lt;vcoffice2@daffodilvarsity.edu.bd&gt;

Dear Mr. Syed Raihan-UI-Islam,

Thank you for the information. We will have the visit on 25th July. We will send the details of the members visiting the DIU campus at the earliest.

Regards

[Quoted text hidden]

---

**Dr. Varun G Menon** <varunmenon@scmsgroup.org>

Wed, Jun 27, 2018 at 11:45 AM

To: "International Affairs, DIU" &lt;int@daffodilvarsity.edu.bd&gt;

Cc: "Office of the International Affairs, DIU" &lt;mobility@daffodilvarsity.edu.bd&gt;, Scholarship News &lt;scholarship@daffodilvarsity.edu.bd&gt;, "International, DIU" &lt;international@daffodilvarsity.edu.bd&gt;, Emran Hossain &lt;emran@daffodilvarsity.edu.bd&gt;, Pramod &lt;pramod@scmsgroup.org&gt;, Indu Nair &lt;indunair@scmsgroup.org&gt;, "Dr. Praveensal C.J." &lt;praveensal@scmsgroup.org&gt;, "VC Office-2, DIU" &lt;vcoffice2@daffodilvarsity.edu.bd&gt;

Dear Mr. Syed Raihan-UI-Islam,

Thank you for the information. We will have the visit on 25th July. We will send the details of the members visiting the DIU campus at the earliest.

Regards

[Quoted text hidden]

---

**International Affairs, DIU** <int@daffodilvarsity.edu.bd>

Wed, Jun 27, 2018 at 11:48 AM

To: "Dr. Varun G Menon" &lt;varunmenon@scmsgroup.org&gt;

Cc: "Office of the International Affairs, DIU" &lt;mobility@daffodilvarsity.edu.bd&gt;, Scholarship News &lt;scholarship@daffodilvarsity.edu.bd&gt;, "International, DIU" &lt;international@daffodilvarsity.edu.bd&gt;, Emran Hossain &lt;emran@daffodilvarsity.edu.bd&gt;, Pramod &lt;pramod@scmsgroup.org&gt;, Indu Nair &lt;indunair@scmsgroup.org&gt;, "Dr. Praveensal C.J." &lt;praveensal@scmsgroup.org&gt;, "VC Office-2, DIU" &lt;vcoffice2@daffodilvarsity.edu.bd&gt;

Dear Dr. Varun

Thanks. I am looking forward.

- With best regards

**Syed Raihan-UI-Islam**

**Senior Administrative Officer, International Affairs**

**Daffodil International University**

102/1, Shukrabad, Dhanmondi, Dhaka-1207, Bangladesh.

Tel: **+88 02 9138234 (Ext: 237)** | Mob: **+88-01811458865**

WhatsApp/Viber/Wechat: **+88-01920012744**

[Quoted text hidden]

---

**Dr. Varun G Menon** <varunmenon@scmsgroup.org>

Thu, Jun 28, 2018 at 7:50 AM

To: "International Affairs, DIU" &lt;int@daffodilvarsity.edu.bd&gt;

Cc: "Office of the International Affairs, DIU" &lt;mobility@daffodilvarsity.edu.bd&gt;, Scholarship News &lt;scholarship@daffodilvarsity.edu.bd&gt;, "International, DIU" &lt;international@daffodilvarsity.edu.bd&gt;, Emran Hossain &lt;emran@daffodilvarsity.edu.bd&gt;, "VC Office-2, DIU" &lt;vcoffice2@daffodilvarsity.edu.bd&gt;

Dear Mr. Syed Raihan-UI-Islam,

Please see below the details of members visiting DIU on 25th July 2018. Please send us the **invitation letter for the Visa** based on this information.

**Names**

Prof. **PRAMOD PRATHAPACHANDRAN THEVANNOOR**, Vice Chairman, SCMS Group of Educational Institutions.

Dr. **VARUN GIRIJAN MENON**, Associate Professor and International Relations in-charge, SCMS Group of Educational Institutions.

**Address**

SCMS Group of Educational Institutions  
SCMS Campus, Prathap Nagar  
Muttom, Aluva  
Cochin – 683 106, Kerala, INDIA

Let me know any further information required.

Thanks and Regards,

**Dr. Varun G Menon**

Associate Professor-Computer Science Engineering  
Exe. Officer-Corporate Relations & International Collaborations  
SCMS School of Engineering and Technology  
Kerala, India-683582  
Office: +91-484-2450330 Mob: +91-8714504684  
Web: <http://www.scmsgroup.org/sset/computer-science-engineering/dr-varun-g-memon>



**SCMS**  
School of Engineering & Technology

[Quoted text hidden]

---

**International Affairs, DIU** <int@daffodilvarsity.edu.bd> Thu, Jun 28, 2018 at 1:09 PM  
To: "Dr. Varun G Menon" <varunmenon@scmsgroup.org>  
Cc: "Office of the International Affairs, DIU" <mobility@daffodilvarsity.edu.bd>, Scholarship News <scholarship@daffodilvarsity.edu.bd>, "International, DIU" <international@daffodilvarsity.edu.bd>, Emran Hossain <emran@daffodilvarsity.edu.bd>, "VC Office-2, DIU" <vcoffice2@daffodilvarsity.edu.bd>

Dear Dr. Varun

Please find the attached letter of Invitation for both of you to visit us for the purpose of the meeting and signing the agreement.

- *With best regards*

**Syed Raihan-UI-Islam**

**Senior Administrative Officer, International Affairs**  
**Daffodil International University**  
102/1, Shukrabad, Dhanmondi, Dhaka-1207, Bangladesh.  
Tel: **+88 02 9138234 (Ext: 237)** | Mob: **+88-01811458865**  
WhatsApp/Viber/Wechat: **+88-01920012744**

[Quoted text hidden]

---

**2 attachments**



**Invitation letter for Prof. PRAMOD PRATHAPACHANDRAN THEVANNOOR.jpg**  
512K

**Invitation letter for Dr. VARUN GIRIJAN MENON.jpg**  
507K





**Dr. Varun G Menon** <varunmenon@scmsgroup.org>

Thu, Jun 28, 2018 at 1:32 PM

To: "International Affairs, DIU" <int@daffodilvarsity.edu.bd>

Cc: "Office of the International Affairs, DIU" <mobility@daffodilvarsity.edu.bd>, Scholarship News <scholarship@daffodilvarsity.edu.bd>, "International, DIU" <international@daffodilvarsity.edu.bd>, Emran Hossain <emran@daffodilvarsity.edu.bd>, "VC Office-2, DIU" <vcoffice2@daffodilvarsity.edu.bd>, Pramod <pramod@scmsgroup.org>

Dear Mr. Syed Raihan-UI-Islam,

Thank you for the invitation letter. Looking forward to the meeting. Will update our schedule once we confirm the flight tickets.

Thanks and Regards,

**Dr. Varun G Menon**

Associate Professor-Computer Science Engineering  
Exe. Officer-Corporate Relations & International Collaborations  
SCMS School of Engineering and Technology  
Kerala, India-683582  
Office: +91-484-2450330 Mob: +91-8714504684  
Web: <http://www.scmsgroup.org/sset/computer-science-engineering/dr-varun-g-menon>



**SCMS**  
School of Engineering & Technology

[Quoted text hidden]

**Dr. Varun G Menon** <varunmenon@scmsgroup.org>

Sun, Jul 1, 2018 at 12:09 PM

To: "International Affairs, DIU" <int@daffodilvarsity.edu.bd>

Cc: "Office of the International Affairs, DIU" <mobility@daffodilvarsity.edu.bd>, Scholarship News <scholarship@daffodilvarsity.edu.bd>, "International, DIU" <international@daffodilvarsity.edu.bd>, Emran Hossain <emran@daffodilvarsity.edu.bd>, "VC Office-2, DIU" <vcoffice2@daffodilvarsity.edu.bd>, Pramod <pramod@scmsgroup.org>, Indu Nair <indunair@scmsgroup.org>, "Dr. Praveensal C.J." <praveensal@scmsgroup.org>

Dear Mr. Syed Raihan-UI-Islam,

Please let me know if you can arrange the MoU signing ceremony and discussion on collaboration at DIU on **25th July morning** as we have flight back to India in the evening.

Thank you,

**Dr. Varun G Menon**

Associate Professor-Computer Science Engineering  
Exe. Officer-Corporate Relations & International Collaborations  
SCMS School of Engineering and Technology  
Kerala, India-683582  
Office: +91-484-2450330 Mob: +91-8714504684  
Web: <http://www.scmsgroup.org/sset/computer-science-engineering/dr-varun-g-menon>



**SCMS**  
School of Engineering & Technology

[Quoted text hidden]

**Dr. Varun G Menon** <varunmenon@scmsgroup.org> Tue, Jul 3, 2018 at 4:27 PM  
To: "International Affairs, DIU" <int@daffodilvarsity.edu.bd>  
Cc: "Office of the International Affairs, DIU" <mobility@daffodilvarsity.edu.bd>, Scholarship News <scholarship@daffodilvarsity.edu.bd>, "International, DIU" <international@daffodilvarsity.edu.bd>, Emran Hossain <emran@daffodilvarsity.edu.bd>, "VC Office-2, DIU" <vcoffice2@daffodilvarsity.edu.bd>, Pramod <pramod@scmsgroup.org>, Indu Nair <indunair@scmsgroup.org>, "Dr. Praveensal C.J." <praveensal@scmsgroup.org>

Dear Mr. Syed Raihan-UI-Islam

Thank you for the valuable time. Please confirm the schedule as discussed and agreed earlier. No need to change the schedule. Our flight is scheduled only in the night.

- MoU Signing Ceremony and discussion session on **25th July 2018** from **3PM to 5PM**
- Visit to DIU Permanent Campus and Lunch on the on that day **9AM to 2PM**

Thanks and Regards,

**Dr. Varun G Menon**

Associate Professor, Computer Science Engineering  
Exe. Officer, Corporate Relations & International Collaborations  
SCMS School of Engineering and Technology  
Kerala, India-683582  
Office: +91-484-2450330 Mob: +91-8714504684  
Web: <http://www.scmsgroup.org/sset/computer-science-engineering/dr-varun-g-menon>



**SCMS**  
School of Engineering & Technology

[Quoted text hidden]

**International Affairs, DIU** <int@daffodilvarsity.edu.bd> Tue, Jul 3, 2018 at 5:04 PM  
To: "Dr. Varun G Menon" <varunmenon@scmsgroup.org>  
Cc: "Office of the International Affairs, DIU" <mobility@daffodilvarsity.edu.bd>, Scholarship News <scholarship@daffodilvarsity.edu.bd>, "International, DIU" <international@daffodilvarsity.edu.bd>, Emran Hossain <emran@daffodilvarsity.edu.bd>, "VC Office-2, DIU" <vcoffice2@daffodilvarsity.edu.bd>, Pramod <pramod@scmsgroup.org>, Indu Nair <indunair@scmsgroup.org>, "Dr. Praveensal C.J." <praveensal@scmsgroup.org>

Dear Dr. Varun

Yes Confirm so far. Thank You

- *With best regards*

**Syed Raihan-UI-Islam**

**Senior Administrative Officer, International Affairs**  
**Daffodil International University**  
102/1, Shukrabad, Dhanmondi, Dhaka-1207, Bangladesh.  
Tel: **+88 02 9138234 (Ext: 237)** | Mob: **+88-01811458865**  
WhatsApp/Viber/Wechat: **+88-01920012744**

[Quoted text hidden]

**Dr. Varun G Menon** <varunmenon@scmsgroup.org> Thu, Jul 5, 2018 at 2:26 PM  
To: "International Affairs, DIU" <int@daffodilvarsity.edu.bd>

Dear Syed,

Please let us know in which campus of DIU is the ceremony and visit arranged. We could see multiple campuses in website. Also let us know good hotel to reserve rooms for stay near the campus.

Regards,

Varun

[Quoted text hidden]

--

Thanks and Regards,

**Dr. Varun G Menon**

[Quoted text hidden]

**Dr. Varun G Menon** <varunmenon@scmsgroup.org>

Thu, Jul 5, 2018 at 4:55 PM

To: "International Affairs, DIU" <int@daffodilvarsity.edu.bd>

Cc: "Office of the International Affairs, DIU" <mobility@daffodilvarsity.edu.bd>, Scholarship News

<scholarship@daffodilvarsity.edu.bd>, "International, DIU" <international@daffodilvarsity.edu.bd>, Emran Hossain

<emran@daffodilvarsity.edu.bd>, "VC Office-2, DIU" <vcoffice2@daffodilvarsity.edu.bd>, Pramod <pramod@scmsgroup.org>,

Indu Nair <indunair@scmsgroup.org>, "Dr. Praveensal C.J." <praveensal@scmsgroup.org>, Anupama COK

<anupama@scmsgroup.org>

Dear Mr. Syed Raihan-UI-Islam,

Thank you for the collaboration with SCMS. Please let us know the campus address of DIU where the visit and MoU signing ceremony is planned so that we could arrange the stay in a hotel near the campus. We could see multiple campuses of DIU in the website. It would also be great if you could give the names of few good hotels near your campus.

Thanks and Regards,

**Dr. Varun G Menon**

Associate Professor, Computer Science Engineering

Exe. Officer, Corporate Relations & International Collaborations

SCMS School of Engineering and Technology

Kerala, India-683582

Office: +91-484-2450330 Mob: +91-8714504684

Web: <http://www.scmsgroup.org/sset/computer-science-engineering/dr-varun-g-menon>



**SCMS**  
School of Engineering & Technology

[Quoted text hidden]

[Quoted text hidden]

[Quoted text hidden]

[Quoted text hidden]

[Quoted text hidden]

[Quoted text hidden]

[Quoted text hidden]

[Quoted text hidden]

[Quoted text hidden]

[Quoted text hidden]

[Quoted text hidden]

[Quoted text hidden]

[Quoted text hidden]

[Quoted text hidden]

[Quoted text hidden]

[Quoted text hidden]

[Quoted text hidden]

[Quoted text hidden]

[Quoted text hidden]

[Quoted text hidden]

[Quoted text hidden]

[Quoted text hidden]

[Quoted text hidden]

[Quoted text hidden]

[Quoted text hidden]

[Quoted text hidden]

[Quoted text hidden]

[Quoted text hidden]

Varun

[Quoted text hidden]

[Quoted text hidden]

[Quoted text hidden]

[Quoted text hidden]

[Quoted text hidden]

[Quoted text hidden]

[Quoted text hidden]

[Quoted text hidden]

[Quoted text hidden]

[Quoted text hidden]

[Quoted text hidden]

[Quoted text hidden]

[Quoted text hidden]

[Quoted text hidden]

[Quoted text hidden]

[Quoted text hidden]

[Quoted text hidden]

[Quoted text hidden]

[Quoted text hidden]

[Quoted text hidden]

[Quoted text hidden]

[Quoted text hidden]

[Quoted text hidden]

[Quoted text hidden]

[Quoted text hidden]

[Quoted text hidden]

[Quoted text hidden]

[Quoted text hidden]

[Quoted text hidden]

[Quoted text hidden]

[Quoted text hidden]

[Quoted text hidden]

[Quoted text hidden]

[Quoted text hidden]

[Quoted text hidden]

Respected Mr. Salahuddin Morsalin

Thank you for your time and consideration. Let me introduce as Dr. Varun G Menon, in charge of International Collaborations at SCMS Group of Educational Institutions, India.

We are interested in having academic collaboration with Daffodil International University. Collaboration could be in the areas of student exchange programs, faculty exchange programs, research collaborations, joint seminars and conferences.

We have a dedicate team of faculty and students working in areas like Robotics, Brain Signal Analysis, Computational fluid dynamics. Water Quality Monitoring and Assessment, Limnology, Water Audit, Environmental Remote Sensing , Android Malware Analysis. Research collaborations in these areas is another possibility.

We have academic collaborations with leading international universities like Vrije University-Brussels, Furtwangen University-Germany, University of Applied Sciences Ravensburg Weingarten- Germany, Shimane University-Japan and more.

**Please let me know if we could discuss and take forward this initiative.**

For your information we are the No 1 ranked private educational institutions in the state. You can find more information about our

institutions in [www.scmsgroup.org](http://www.scmsgroup.org) and about our Engineering Institute in [www.scmsgroup.org/sset/](http://www.scmsgroup.org/sset/)

Have a Great Day.

Thanks and Regards,

**Dr. Varun G Menon**

Associate Professor-Computer Science Engineering  
Exe. Officer-Corporate Relations & International Collaborations  
SCMS School of Engineering and Technology

Kerala, India-683582

Office: +91-484-2450330 Mob: +91-8714504684

Web: <http://www.scmsgroup.org/sset/computer-science-engineering/dr-varun-g-menon>



**SCMS**

School of Engineering & Technology

--

Thanks and Regards,

**Dr. Varun G Menon**

Associate Professor-Computer Science Engineering  
Exe. Officer-Corporate Relations & International Collaborations  
SCMS School of Engineering and Technology

Kerala, India-683582

Office: +91-484-2450330 Mob: +91-8714504684

Web: <http://www.scmsgroup.org/sset/computer-science-engineering/dr-varun-g-menon>



**SCMS**

School of Engineering & Technology

--

Thanks and Regards,

**Dr. Varun G Menon**

Associate Professor-Computer Science Engineering  
Exe. Officer-Corporate Relations & International Collaborations  
SCMS School of Engineering and Technology

Kerala, India-683582

Office: +91-484-2450330 Mob: +91-8714504684

Web: <http://www.scmsgroup.org/sset/computer-science-engineering/dr-varun-g-menon>



**SCMS**  
School of Engineering & Technology

--  
Thanks and Regards,

**Dr. Varun G Menon**

[Quoted text hidden]

---

**International Affairs, DIU** <int@daffodilvarsity.edu.bd> Mon, Jul 9, 2018 at 10:58 AM  
To: "Dr. Varun G Menon" <varunmenon@scmsgroup.org>  
Cc: "Office of the International Affairs, DIU" <mobility@daffodilvarsity.edu.bd>, Scholarship News <scholarship@daffodilvarsity.edu.bd>, "International, DIU" <international@daffodilvarsity.edu.bd>, Emran Hossain <emran@daffodilvarsity.edu.bd>, "VC Office-2, DIU" <vcoffice2@daffodilvarsity.edu.bd>, Pramod <pramod@scmsgroup.org>, Indu Nair <indunair@scmsgroup.org>, "Dr. Praveensal C.J." <praveensal@scmsgroup.org>, Anupama COK <anupama@scmsgroup.org>

Dear Dr. Varun,

Here is the address that i already gave you in whatsapp:

[Daffodil International University](#)  
102/1, Shukrabad, Dhanmondi, Dhaka-1207  
Bangladesh

some hotels nearby our campus:

<http://www.ambalainn.com>

<https://www.panpacific.com/en/hotels-and-resorts/pp-dhaka.html>

- With best regards

**Syed Raihan-UI-Islam**

**Senior Administrative Officer, International Affairs**  
**Daffodil International University**

102/1, Shukrabad, Dhanmondi, Dhaka-1207, Bangladesh.

Tel: **+88 02 9138234 (Ext: 237)** | Mob: **+88-01811458865**

WhatsApp/Viber/Wechat: **+88-01920012744**

On Thu, Jul 5, 2018 at 5:25 PM, Dr. Varun G Menon <varunmenon@scmsgroup.org> wrote:

Dear Mr. Syed Raihan-UI-Islam,

Thank you for the collaboration with SCMS. Please let us know the campus address of DIU where the visit and MoU signing ceremony is planned so that we could arrange the stay in a hotel near the campus. We could see multiple campuses of DIU in the website. It would also be great if you could give the names of few good hotels near your campus.

Thanks and Regards,

**Dr. Varun G Menon**

Associate Professor, Computer Science Engineering

Exe. Officer, Corporate Relations & International Collaborations  
SCMS School of Engineering and Technology  
Kerala, India-683582  
Office: +91-484-2450330 Mob: +91-8714504684  
Web: <http://www.scmsgroup.org/sset/computer-science-engineering/dr-varun-g-menon>



**SCMS**  
School of Engineering & Technology

On Tue, Jul 3, 2018 at 5:04 PM, International Affairs, DIU <[int@daffodilvarsity.edu.bd](mailto:int@daffodilvarsity.edu.bd)> wrote:  
Dear Dr. Varun

Yes Confirm so far. Thank You

- With best regards

**Syed Raihan-UI-Islam**

**Senior Administrative Officer, International Affairs**  
**Daffodil International University**  
102/1, Shukrabad, Dhanmondi, Dhaka-1207, Bangladesh.  
Tel: **+88 02 9138234 (Ext: 237)** | Mob: **+88-01811458865**  
WhatsApp/Viber/Wechat: **+88-01920012744**

On Tue, Jul 3, 2018 at 3:57 AM, Dr. Varun G Menon <[varunmenon@scmsgroup.org](mailto:varunmenon@scmsgroup.org)> wrote:  
Dear Mr. Syed Raihan-UI-Islam

Thank you for the valuable time. Please confirm the schedule as discussed and agreed earlier. No need to change the schedule. Our flight is scheduled only in the night.

- MoU Signing Ceremony and discussion session on **25th July 2018 from 3PM to 5PM**
- Visit to DIU Permanent Campus and Lunch on the on that day **9AM to 2PM**

Thanks and Regards,

**Dr. Varun G Menon**

Associate Professor, Computer Science Engineering  
Exe. Officer, Corporate Relations & International Collaborations  
SCMS School of Engineering and Technology  
Kerala, India-683582  
Office: +91-484-2450330 Mob: +91-8714504684  
Web: <http://www.scmsgroup.org/sset/computer-science-engineering/dr-varun-g-menon>



**SCMS**  
School of Engineering & Technology

On Sun, Jul 1, 2018 at 12:09 PM, Dr. Varun G Menon <[varunmenon@scmsgroup.org](mailto:varunmenon@scmsgroup.org)> wrote:  
Dear Mr. Syed Raihan-UI-Islam,

Please let me know if you can arrange the MoU signing ceremony and discussion on collaboration at DIU on **25th July morning** as we have flight back to India in the evening.

Thank you,

**Dr. Varun G Menon**

Associate Professor-Computer Science Engineering  
Exe. Officer-Corporate Relations & International Collaborations  
SCMS School of Engineering and Technology  
Kerala, India-683582  
Office: +91-484-2450330 Mob: +91-8714504684  
Web: <http://www.scmsgroup.org/sset/computer-science-engineering/dr-varun-g-menon>



**SCMS**  
School of Engineering & Technology

On Thu, Jun 28, 2018 at 1:32 PM, Dr. Varun G Menon <[varunmenon@scmsgroup.org](mailto:varunmenon@scmsgroup.org)> wrote:

Dear Mr. Syed Raihan-UI-Islam,

Thank you for the invitation letter. Looking forward to the meeting. Will update our schedule once we confirm the flight tickets.

Thanks and Regards,

**Dr. Varun G Menon**

Associate Professor-Computer Science Engineering  
Exe. Officer-Corporate Relations & International Collaborations  
SCMS School of Engineering and Technology  
Kerala, India-683582  
Office: +91-484-2450330 Mob: +91-8714504684  
Web: <http://www.scmsgroup.org/sset/computer-science-engineering/dr-varun-g-menon>



**SCMS**  
School of Engineering & Technology

On Thu, Jun 28, 2018 at 1:09 PM, International Affairs, DIU <[int@daffodilvarsity.edu.bd](mailto:int@daffodilvarsity.edu.bd)> wrote:

Dear Dr. Varun

Please find the attached letter of Invitation for both of you to visit us for the purpose of the meeting and signing the agreement.

- With best regards

**Syed Raihan-UI-Islam**

**Senior Administrative Officer, International Affairs**  
**Daffodil International University**  
102/1, Shukrabad, Dhanmondi, Dhaka-1207, Bangladesh.  
Tel: **+88 02 9138234 (Ext: 237)** | Mob: **+88-01811458865**  
WhatsApp/Viber/Wechat: **+88-01920012744**

On Thu, Jun 28, 2018 at 8:20 AM, Dr. Varun G Menon <[varunmenon@scmsgroup.org](mailto:varunmenon@scmsgroup.org)> wrote:

Dear Mr. Syed Raihan-UI-Islam,

Please see below the details of members visiting DIU on 25th July 2018. Please send us the **invitation letter for the Visa** based on this information.

**Names**

Prof. **PRAMOD PRATHAPACHANDRAN THEVANNOOR**, Vice Chairman, SCMS Group of Educational Institutions.

Dr. **VARUN GIRIJAN MENON**, Associate Professor and International Relations in-charge, SCMS Group of Educational Institutions.

**Address**

SCMS Group of Educational Institutions  
SCMS Campus, Prathap Nagar  
Muttom, Aluva  
Cochin – 683 106, Kerala, INDIA

Let me know any further information required.

Thanks and Regards,



**Dr. Varun G Menon**

Associate Professor-Computer Science Engineering  
Exe. Officer-Corporate Relations & International Collaborations  
SCMS School of Engineering and Technology  
Kerala, India-683582  
Office: +91-484-2450330 Mob: +91-8714504684  
Web: <http://www.scmsgroup.org/sset/computer-science-engineering/dr-varun-g-memon>



**SCMS**  
School of Engineering & Technology

On Wed, Jun 27, 2018 at 11:48 AM, International Affairs, DIU <[int@daffodilvarsity.edu.bd](mailto:int@daffodilvarsity.edu.bd)> wrote:  
Dear Dr. Varun

Thanks. I am looking forward.

- With best regards

**Syed Raihan-UI-Islam**

**Senior Administrative Officer, International Affairs**  
**Daffodil International University**  
102/1, Shukrabad, Dhanmondi, Dhaka-1207, Bangladesh.  
Tel: **+88 02 9138234 (Ext: 237)** | Mob: **+88-01811458865**  
WhatsApp/Viber/Wechat: **+88-01920012744**

On Wed, Jun 27, 2018 at 12:15 PM, Dr. Varun G Menon <[varunmenon@scmsgroup.org](mailto:varunmenon@scmsgroup.org)> wrote:

Dear Mr. Syed Raihan-UI-Islam,  
Thank you for the information. We will have the visit on 25th July. We will send the details of the members visiting the DIU campus at the earliest.  
Regards  
Varun

On Wednesday, June 27, 2018, International Affairs, DIU <[int@daffodilvarsity.edu.bd](mailto:int@daffodilvarsity.edu.bd)> wrote:  
Dear Dr. Varun,

I have discussed with the Office of the Vice Chancellor

We can arrange the MoU Signing Ceremony and discussion session on **25 July 2018** from **3PM to 5PM**  
We can also arrange to visit our Permanent Campus and Lunch on the on that day 9AM to 2PM too.

Let us know if the time and date is convenient for your visit

Looking forward to hearing from you.

- With best regards

**Syed Raihan-UI-Islam**

**Senior Administrative Officer, International Affairs**  
**Daffodil International University**  
102/1, Shukrabad, Dhanmondi, Dhaka-1207, Bangladesh.  
Tel: **+88 02 9138234 (Ext: 237)** | Mob: **+88-01811458865**  
WhatsApp/Viber/Wechat: **+88-01920012744**

On Wed, Jun 27, 2018 at 11:18 AM, Dr. Varun G Menon <[varunmenon@scmsgroup.org](mailto:varunmenon@scmsgroup.org)> wrote:

Dear Mr. Syed Raihan-UI-Islam,  
Can we have the visit between July 24 and 27. Our Vice Chairman is traveling on other dates in July.  
Please let me know.

Varun

On Wednesday, June 27, 2018, International Affairs, DIU <[int@daffodilvarsity.edu.bd](mailto:int@daffodilvarsity.edu.bd)> wrote:  
Dear Dr. Varun

Can we shift it to the next week I mean in between 15 to 20 July?

- With best regards

**Syed Raihan-UI-Islam**

**Senior Administrative Officer, International Affairs**

**Daffodil International University**

102/1, Shukrabad, Dhanmondi, Dhaka-1207, Bangladesh.

Tel: **+88 02 9138234 (Ext: 237)** | Mob: **+88-01811458865**

WhatsApp/Viber/Wechat: **+88-01920012744**

On Wed, Jun 27, 2018 at 10:55 AM, Dr. Varun G Menon <[varunmenon@scmsgroup.org](mailto:varunmenon@scmsgroup.org)> wrote:

Dear Mr. Syed Raihan-UI-Islam,

Thank you for the message. We would like to visit DIU between 10th and 14th July. Please let us know if the date is convenient at your end. Also it would be great if you could send us an Invitation letter which could be produced for the Visa.

Let me know any further details required.

Varun

On Tuesday, June 26, 2018, International Affairs, DIU <[int@daffodilvarsity.edu.bd](mailto:int@daffodilvarsity.edu.bd)> wrote:

Dear Dr. Varun

That is a good idea. Let us know your possible dates to visit us and sign the agreement between both of the universities.

- With best regards

**Syed Raihan-UI-Islam**

**Senior Administrative Officer, International Affairs**

**Daffodil International University**

102/1, Shukrabad, Dhanmondi, Dhaka-1207, Bangladesh.

Tel: **+88 02 9138234 (Ext: 237)** | Mob: **+88-01811458865**

WhatsApp/Viber/Wechat: **+88-01920012744**

On Tue, Jun 26, 2018 at 10:38 PM, Dr. Varun G Menon <[varunmenon@scmsgroup.org](mailto:varunmenon@scmsgroup.org)> wrote:

Dear Mr. Syed Raihan-UI-Islam,

Thank you for the collaboration with SCMS. We would like to visit the DIU campus on a favorable date and would like to sign the MoU with the Vice Chancellor at DIU.

We would be more than happy to host the DIU team with Vice Chancellor in our campus in future. Please let me know your thoughts.

Thanks and Regards,

**Dr. Varun G Menon**

Associate Professor-Computer Science Engineering

Exe. Officer-Corporate Relations & International Collaborations

SCMS School of Engineering and Technology

Kerala, India-683582

Office: +91-484-2450330 Mob: +91-8714504684

Web: <http://www.scmsgroup.org/sset/computer-science-engineering/dr-varun-g-menon>



**SCMS**  
School of Engineering & Technology

On Tue, Jun 26, 2018 at 6:54 PM, International Affairs, DIU <[int@daffodilvarsity.edu.bd](mailto:int@daffodilvarsity.edu.bd)> wrote:

Dear Dr. Varun

Thank you very much for the agreement final copy. It's fine

May I request you to sign the agreement and send the copies to me either scan copy in my email or 2 original copies in my address given in my email signature

- With best regards

**Syed Raihan-UI-Islam**

**Senior Administrative Officer, International Affairs**  
**Daffodil International University**

102/1, Shukrabad, Dhanmondi, Dhaka-1207, Bangladesh.

Tel: **+88 02 9138234 (Ext: 237)** | Mob: **+88-01811458865**

WhatsApp/Viber/Wechat: **+88-01920012744**

On Tue, Jun 26, 2018 at 7:01 PM, Dr. Varun G Menon <[varunmenon@scmsgroup.org](mailto:varunmenon@scmsgroup.org)> wrote:

Dear Mr. Syed Raihan-UI-Islam,

Thank you for the collaboration with SCMS. Please see the attached MoU draft approved by our Vice Chairman. Please let me know the remaining procedures including the signing of the MoU.

Thanks and Regards,

**Dr. Varun G Menon**

Associate Professor-Computer Science Engineering

Exe. Officer-Corporate Relations & International Collaborations

SCMS School of Engineering and Technology

Kerala, India-683582

Office: +91-484-2450330 Mob: +91-8714504684

Web: <http://www.scmsgroup.org/sset/computer-science-engineering/dr-varun-g-menon>



**SCMS**

School of Engineering & Technology

On Mon, Jun 25, 2018 at 3:55 PM, International Affairs, DIU <[int@daffodilvarsity.edu.bd](mailto:int@daffodilvarsity.edu.bd)> wrote:

Dear Dr. Varun

Thank you so much for your email and letting us know the update.

- With best regards

**Syed Raihan-UI-Islam**

**Senior Administrative Officer, International Affairs**  
**Daffodil International University**

102/1, Shukrabad, Dhanmondi, Dhaka-1207, Bangladesh.

Tel: **+88 02 9138234 (Ext: 237)** | Mob: **+88-01811458865**

WhatsApp/Viber/Wechat: **+88-01920012744**

On Mon, Jun 25, 2018 at 4:14 PM, Dr. Varun G Menon <[varunmenon@scmsgroup.org](mailto:varunmenon@scmsgroup.org)> wrote:

Dear Mr. Syed Raihan-UI-Islam,

Thank you for the collaboration with SCMS. I have presented the MoU with the Vice Chairman for approval. Once the approval is obtained, I will send back the approved soft copy of the MoU.

I have discussed about the Short Term Internships for students from DIU at the Centre for Robotics, SCMS with the Director, Robotics Lab. He has promised to

send me The Best Plan for DIU students within two days. I will send you the same at the earliest.

Thanks and Regards,

**Dr. Varun G Menon**

Associate Professor-Computer Science Engineering  
Exe. Officer-Corporate Relations & International Collaborations  
SCMS School of Engineering and Technology  
Kerala, India-683582

Office: +91-484-2450330 Mob: +91-8714504684

Web: <http://www.scmsgroup.org/sset/computer-science-engineering/dr-varun-g-menon>



**SCMS**  
School of Engineering & Technology

On Sun, Jun 24, 2018 at 12:56 AM, Dr. Varun G Menon  
<[varunmenon@scmsgroup.org](mailto:varunmenon@scmsgroup.org)> wrote:

Dear Mr. Syed Raihan-UI-Islam,

Thank you for the email. Will inform the Professor's in charge of the Cyber Security and Robotics research centers about the program plan. Will sent you the documents soon.

Have a Great Day.

Thanks and Regards,

**Dr. Varun G Menon**

Associate Professor-Computer Science Engineering  
Exe. Officer-Corporate Relations & International Collaborations  
SCMS School of Engineering and Technology  
Kerala, India-683582

Office: +91-484-2450330 Mob: +91-8714504684

Web: <http://www.scmsgroup.org/sset/computer-science-engineering/dr-varun-g-menon>



**SCMS**  
School of Engineering & Technology

On Sun, Jun 24, 2018 at 12:17 AM, International Affairs, DIU  
<[int@daffodilvarsity.edu.bd](mailto:int@daffodilvarsity.edu.bd)> wrote:

Dear Dr, Varun

Thank you very much for your quick response.

It would be great if you can share any proposal or program plan with all details, course plan, costing etc of the Summer internships based on Cyber Security and Robotics so that we could check and show t our students for interest.

Hope to receive the agreement and the program proposals soon. Have a great day !

- With best regards

**Syed Raihan-UI-Islam**

**Senior Administrative Officer, International Affairs**  
**Daffodil International University**

102/1, Shukrabad, Dhanmondi, Dhaka-1207, Bangladesh.  
Tel: **+88 02 9138234 (Ext: 237)** | Mob: **+88-01811458865**  
WhatsApp/Viber/Wechat: **+88-01920012744**

On Sun, Jun 24, 2018 at 12:35 AM, Dr. Varun G Menon  
<[varunmenon@scmsgroup.org](mailto:varunmenon@scmsgroup.org)> wrote:

Dear Mr. Syed Raihan-UI-Islam,

Thank you for the information about Daffodil International University.  
Will complete the agreement copy and send you at the earliest.

We have 5 active research groups in our Engineering College that include Centre for Robotics, Centre for Cyber Security, Hydrodynamics and Computational Fluid Dynamics, Antennas and Radiation, Centre for Sustainable Water Technology and Management. Students from your University can do summer internships and short term projects with these project groups.

Besides we also have one of the leading Management Institute in India and also Biotechnology Research Centre.

Thank you for the collaboration. Will send you the document soon.

Regards,

**Dr. Varun G Menon**

Associate Professor-Computer Science Engineering  
Exe. Officer-Corporate Relations & International Collaborations  
SCMS School of Engineering and Technology  
Kerala, India-683582  
Office: +91-484-2450330 Mob: +91-8714504684  
Web: <http://www.scmsgroup.org/sset/computer-science-engineering/dr-varun-g-menon>



**SCMS**

School of Engineering & Technology

On Sat, Jun 23, 2018 at 6:42 PM, International Affairs, DIU  
<[int@daffodilvarsity.edu.bd](mailto:int@daffodilvarsity.edu.bd)> wrote:

**Dear Dr. Varun G Menon,**

**Greetings from DIU!**

**Thanks for your email and showing interest in the academic partnership. Yes, we can collaborate in the areas of student exchange programs, faculty exchange programs, summer school research collaborations, joint seminars and conferences.**

**I have attached here the sample agreement copy of DIU, Could you please check and fill it with your information. Besides, I have attached here the fact sheet of DIU where you can check our common details and department.**

**Your CSE, ECE and EEE Department can be a good prospect between both universities. Let us know your observation**

**Looking forward to hearing from you soon.**

*- With best regards*

**Syed Raihan-UI-Islam**

**Senior Administrative Officer, International Affairs**  
**Daffodil International University**

102/1, Shukrabad, Dhanmondi, Dhaka-1207, Bangladesh.  
Tel: **+88 02 9138234 (Ext: 237)** | Mob: **+88-01811458865**  
WhatsApp/Viber/Wechat: **+88-01920012744**

Respected Mr. Salahuddin Morsalin

Thank you for your time and consideration. Let me introduce as Dr. Varun G Menon, in charge of International Collaborations at SCMS Group of Educational Institutions, India.

We are interested in having academic collaboration with Daffodil International University. Collaboration could be in the areas of student exchange programs, faculty exchange programs, research collaborations, joint seminars and conferences.

We have a dedicate team of faculty and students working in areas like Robotics, Brain Signal Analysis, Computational fluid dynamics. Water Quality Monitoring and Assessment, Limnology, Water Audit, Environmental Remote Sensing , Android Malware Analysis. Research collaborations in these areas is another possibility.

We have academic collaborations with leading international universities like Vrije University-Brussels, Furtwangen University-Germany, University of Applied Sciences Ravensburg Weingarten-Germany, Shimane University-Japan and more.

**Please let me know if we could discuss and take forward this initiative.**

For your information we are the No 1 ranked private educational institutions in the state. You can find more information about our institutions in [www.scmsgroup.org](http://www.scmsgroup.org) and about our Engineering Institute in [www.scmsgroup.org/sset/](http://www.scmsgroup.org/sset/)

Have a Great Day.

Thanks and Regards,

**Dr. Varun G Menon**

Associate Professor-Computer Science Engineering  
Exe. Officer-Corporate Relations & International Collaborations  
SCMS School of Engineering and Technology  
Kerala, India-683582  
Office: +91-484-2450330 Mob: +91-8714504684  
Web: <http://www.scmsgroup.org/sset/computer-science-engineering/dr-varun-g-memon>



**SCMS**  
School of Engineering & Technology

--  
Thanks and Regards,

**Dr. Varun G Menon**

Associate Professor-Computer Science Engineering  
Exe. Officer-Corporate Relations & International Collaborations  
SCMS School of Engineering and Technology  
Kerala, India-683582  
Office: +91-484-2450330 Mob: +91-8714504684  
Web: <http://www.scmsgroup.org/sset/computer-science-engineering/dr-varun-g-menon>



**SCMS**  
School of Engineering & Technology

--  
Thanks and Regards,

**Dr. Varun G Menon**  
Associate Professor-Computer Science Engineering  
Exe. Officer-Corporate Relations & International Collaborations  
SCMS School of Engineering and Technology  
Kerala, India-683582  
Office: +91-484-2450330 Mob: +91-8714504684  
Web: <http://www.scmsgroup.org/sset/computer-science-engineering/dr-varun-g-menon>



**SCMS**  
School of Engineering & Technology

--  
Thanks and Regards,

**Dr. Varun G Menon**  
Associate Professor-Computer Science Engineering  
Exe. Officer-Corporate Relations & International Collaborations  
SCMS School of Engineering and Technology  
Kerala, India-683582  
Office: +91-484-2450330 Mob: +91-8714504684  
Web: <http://www.scmsgroup.org/sset/computer-science-engineering/dr-varun-g-menon>



**SCMS**  
School of Engineering & Technology

To: "International Affairs, DIU" <int@daffodilvarsity.edu.bd>  
Cc: "Office of the International Affairs, DIU" <mobility@daffodilvarsity.edu.bd>, Scholarship News <scholarship@daffodilvarsity.edu.bd>, "International, DIU" <international@daffodilvarsity.edu.bd>, Emran Hossain <emran@daffodilvarsity.edu.bd>, "VC Office-2, DIU" <vcoffice2@daffodilvarsity.edu.bd>, Pramod <pramod@scmsgroup.org>, Anupama COK <anupama@scmsgroup.org>

Dear Mr. Syed Raihan-UI-Islam,  
Thank you for the collaboration with SCMS.

Kindly see below the details of hotel reserved by us  
**Hotel Name: Best Western B/W La Vinci Hotel**  
**Address: 54, Kawran Bazar, Dhaka, Bangladesh 1215**

Please let me know if you would be arranging a pick up from the hotel to the DIU campus. We could start at 1.30 pm from the hotel to the DIU campus for the visit and signing of the MoU.

Thanks and Regards,

**Dr. Varun G Menon**  
Associate Professor & Head of International Relations  
SCMS Group of Educational Institutions  
Cochin, Kerala, India-683106  
Office: +91-484-2450330 Mob: +91-8714504684  
Web: <http://www.scmsgroup.org>



On Mon, Jul 9, 2018 at 10:58 AM, International Affairs, DIU <int@daffodilvarsity.edu.bd> wrote:  
Dear Dr. Varun,

Here is the address that i already gave you in whatsapp:

[Daffodil International University](#)  
102/1, Shukrabad, Dhanmondi, Dhaka-1207  
Bangladesh

some hotels nearby our campus:

<http://www.ambalainn.com>

<https://www.panpacific.com/en/hotels-and-resorts/pp-dhaka.html>

- *With best regards*

**Syed Raihan-UI-Islam**  
**Senior Administrative Officer, International Affairs**  
**Daffodil International University**  
102/1, Shukrabad, Dhanmondi, Dhaka-1207, Bangladesh.  
Tel: **+88 02 9138234 (Ext: 237)** | Mob: **+88-01811458865**  
WhatsApp/Viber/Wechat: **+88-01920012744**

On Thu, Jul 5, 2018 at 5:25 PM, Dr. Varun G Menon <varunmenon@scmsgroup.org> wrote:

Dear Mr. Syed Raihan-UI-Islam,  
Thank you for the collaboration with SCMS. Please let us know the campus address of DIU where the visit and MoU signing ceremony is planned so that we could arrange the stay in a hotel near the campus. We could see multiple campuses of DIU in the website. It would also be great if you could give the names of few good hotels near your campus.

Thanks and Regards,

**Dr. Varun G Menon**  
Associate Professor, Computer Science Engineering  
Exe. Officer, Corporate Relations & International Collaborations  
SCMS School of Engineering and Technology



Kerala, India-683582

Office: +91-484-2450330 Mob: +91-8714504684

Web: <http://www.scmsgroup.org/sset/computer-science-engineering/dr-varun-g-menon>



**SCMS**  
School of Engineering & Technology

On Tue, Jul 3, 2018 at 5:04 PM, International Affairs, DIU <[int@daffodilvarsity.edu.bd](mailto:int@daffodilvarsity.edu.bd)> wrote:

Dear Dr. Varun

Yes Confirm so far. Thank You

- With best regards

**Syed Raihan-UI-Islam**

**Senior Administrative Officer, International Affairs**

**Daffodil Intersity**

102/1, Shukrabad, Dhanmondi, Dhaka-1207, Bangladesh.

Tel: **+88 02 9138234 (Ext: 237)** | Mob: **+88-01811458865**

WhatsApp/Viber/Wechat: **+88-01920012744**

On Tue, Jul 3, 2018 at 3:57 AM, Dr. Varun G Menon <[varunmenon@scmsgroup.org](mailto:varunmenon@scmsgroup.org)> wrote:

Dear Mr. Syed Raihan-UI-Islam

Thank you for the valuable time. Please confirm the schedule as discussed and agreed earlier. No need to change the schedule. Our flight is scheduled only in the night.

- MoU Signing Ceremony and discussion session on **25th July 2018** from **3PM to 5PM**
- Visit to DIU Permanent Campus and Lunch on the on that day **9AM to 2PM**

Thanks and Regards,

**Dr. Varun G Menon**

Associate Professor, Computer Science Engineering

Exe. Officer, Corporate Relations & International Collaborations

SCMS School of Engineering and Technology

Kerala, India-683582

Office: +91-484-2450330 Mob: +91-8714504684

Web: <http://www.scmsgroup.org/sset/computer-science-engineering/dr-varun-g-menon>



**SCMS**  
School of Engineering & Technology

On Sun, Jul 1, 2018 at 12:09 PM, Dr. Varun G Menon <[varunmenon@scmsgroup.org](mailto:varunmenon@scmsgroup.org)> wrote:

Dear Mr. Syed Raihan-UI-Islam,

Please let me know if you can arrange the MoU signing ceremony and discussion on collaboration at DIU on **25th July morning** as we have flight back to India in the evening.

Thank you,

**Dr. Varun G Menon**

Associate Professor-Computer Science Engineering

Exe. Officer-Corporate Relations & International Collaborations

SCMS School of Engineering and Technology

Kerala, India-683582

Office: +91-484-2450330 Mob: +91-8714504684

Web: <http://www.scmsgroup.org/sset/computer-science-engineering/dr-varun-g-menon>



**SCMS**  
School of Engineering & Technology

On Thu, Jun 28, 2018 at 1:32 PM, Dr. Varun G Menon <[varunmenon@scmsgroup.org](mailto:varunmenon@scmsgroup.org)> wrote:

Dear Mr. Syed Raihan-UI-Islam,

Thank you for the invitation letter. Looking forward to the meeting. Will update our schedule once we confirm the flight tickets.

Thanks and Regards,

**Dr. Varun G Menon**

Associate Professor-Computer Science Engineering

Exe. Officer-Corporate Relations & International Collaborations

SCMS School of Engineering and Technology

Kerala, India-683582

Office: +91-484-2450330 Mob: +91-8714504684

Web: <http://www.scmsgroup.org/sset/computer-science-engineering/dr-varun-g-menon>



**SCMS**  
School of Engineering & Technology

On Thu, Jun 28, 2018 at 1:09 PM, International Affairs, DIU <[int@daffodilvarsity.edu.bd](mailto:int@daffodilvarsity.edu.bd)> wrote:

Dear Dr. Varun

Please find the attached letter of Invitation for both of you to visit us for the purpose of the meeting and signing the agreement.

- With best regards

**Syed Raihan-UI-Islam**

**Senior Administrative Officer, International Affairs**

**Daffodil International University**

102/1, Shukrabad, Dhanmondi, Dhaka-1207, Bangladesh.

Tel: **+88 02 9138234 (Ext: 237)** | Mob: **+88-01811458865**

WhatsApp/Viber/Wechat: **+88-01920012744**

On Thu, Jun 28, 2018 at 8:20 AM, Dr. Varun G Menon <[varunmenon@scmsgroup.org](mailto:varunmenon@scmsgroup.org)> wrote:

Dear Mr. Syed Raihan-UI-Islam,

Please see below the details of members visiting DIU on 25th July 2018. Please send us the **invitation letter for the Visa** based on this information.

**Names**

Prof. **PRAMOD PRATHAPACHANDRAN THEVANNOOR**, Vice Chairman, SCMS Group of Educational Institutions.

Dr. **VARUN GIRIJAN MENON**, Associate Professor and International Relations in-charge, SCMS Group of Educational Institutions.

**Address**

SCMS Group of Educational Institutions

SCMS Campus, Prathap Nagar

Muttom, Aluva

Cochin – 683 106, Kerala, INDIA

Let me know any further information required.

Thanks and Regards,

**Dr. Varun G Menon**

Associate Professor-Computer Science Engineering  
Exe. Officer-Corporate Relations & International Collaborations  
SCMS School of Engineering and Technology  
Kerala, India-683582  
Office: +91-484-2450330 Mob: +91-8714504684  
Web: <http://www.scmsgroup.org/sset/computer-science-engineering/dr-varun-g-menon>



**SCMS**  
School of Engineering & Technology

On Wed, Jun 27, 2018 at 11:48 AM, International Affairs, DIU <[int@daffodilvarsity.edu.bd](mailto:int@daffodilvarsity.edu.bd)> wrote:  
Dear Dr. Varun

Thanks. I am looking forward.

- With best regards

**Syed Raihan-UI-Islam**

**Senior Administrative Officer, International Affairs**  
**Daffodil International University**  
102/1, Shukrabad, Dhanmondi, Dhaka-1207, Bangladesh.  
Tel: **+88 02 9138234 (Ext: 237)** | Mob: **+88-01811458865**  
WhatsApp/Viber/Wechat: **+88-01920012744**

On Wed, Jun 27, 2018 at 12:15 PM, Dr. Varun G Menon <[varunmenon@scmsgroup.org](mailto:varunmenon@scmsgroup.org)> wrote:  
Dear Mr. Syed Raihan-UI-Islam,  
Thank you for the information. We will have the visit on 25th July. We will send the details of the members visiting the DIU campus at the earliest.  
Regards  
Varun

On Wednesday, June 27, 2018, International Affairs, DIU <[int@daffodilvarsity.edu.bd](mailto:int@daffodilvarsity.edu.bd)> wrote:  
Dear Dr. Varun,

I have discussed with the Office of the Vice Chancellor

We can arrange the MoU Signing Ceremony and discussion session on **25 July 2018** from **3PM to 5PM**  
We can also arrange to visit our Permanent Campus and Lunch on the on that day 9AM to 2PM too.

Let us know if the time and date is convenient for your visit

Looking forward to hearing from you.

- With best regards

**Syed Raihan-UI-Islam**

**Senior Administrative Officer, International Affairs**  
**Daffodil International University**  
102/1, Shukrabad, Dhanmondi, Dhaka-1207, Bangladesh.  
Tel: **+88 02 9138234 (Ext: 237)** | Mob: **+88-01811458865**  
WhatsApp/Viber/Wechat: **+88-01920012744**

On Wed, Jun 27, 2018 at 11:18 AM, Dr. Varun G Menon <[varunmenon@scmsgroup.org](mailto:varunmenon@scmsgroup.org)> wrote:  
Dear Mr. Syed Raihan-UI-Islam,  
Can we have the visit between July 24 and 27. Our Vice Chairman is traveling on other dates in July.  
Please let me know.

Varun

On Wednesday, June 27, 2018, International Affairs, DIU <[int@daffodilvarsity.edu.bd](mailto:int@daffodilvarsity.edu.bd)> wrote:  
Dear Dr. Varun

Can we shift it to the next week I mean in between 15 to 20 July?

- *With best regards*

**Syed Raihan-UI-Islam**

**Senior Administrative Officer, International Affairs**

**Daffodil International University**

102/1, Shukrabad, Dhanmondi, Dhaka-1207, Bangladesh.

Tel: **+88 02 9138234 (Ext: 237)** | Mob: **+88-01811458865**

WhatsApp/Viber/Wechat: **+88-01920012744**

On Wed, Jun 27, 2018 at 10:55 AM, Dr. Varun G Menon <[varunmenon@scmsgroup.org](mailto:varunmenon@scmsgroup.org)> wrote:

Dear Mr. Syed Raihan-UI-Islam,

Thank you for the message. We would like to visit DIU between 10th and 14th July. Please let us know if the date is convenient at your end. Also it would be great if you could send us an Invitation letter which could be produced for the Visa.

Let me know any further details required.

Varun

On Tuesday, June 26, 2018, International Affairs, DIU <[int@daffodilvarsity.edu.bd](mailto:int@daffodilvarsity.edu.bd)> wrote:

Dear Dr. Varun

That is a good idea. Let us know your possible dates to visit us and sign the agreement between both of the universities.

- *With best regards*

**Syed Raihan-UI-Islam**

**Senior Administrative Officer, International Affairs**

**Daffodil International University**

102/1, Shukrabad, Dhanmondi, Dhaka-1207, Bangladesh.

Tel: **+88 02 9138234 (Ext: 237)** | Mob: **+88-01811458865**

WhatsApp/Viber/Wechat: **+88-01920012744**

On Tue, Jun 26, 2018 at 10:38 PM, Dr. Varun G Menon <[varunmenon@scmsgroup.org](mailto:varunmenon@scmsgroup.org)> wrote:

Dear Mr. Syed Raihan-UI-Islam,

Thank you for the collaboration with SCMS. We would like to visit the DIU campus on a favorable date and would like to sign the MoU with the Vice Chancellor at DIU. We would be more than happy to host the DIU team with Vice Chancellor in our campus in future. Please let me know your thoughts.

Thanks and Regards,

**Dr. Varun G Menon**

Associate Professor-Computer Science Engineering

Exe. Officer-Corporate Relations & International Collaborations

SCMS School of Engineering and Technology

Kerala, India-683582

Office: +91-484-2450330 Mob: +91-8714504684

Web: <http://www.scmsgroup.org/sset/computer-science-engineering/dr-varun-g-menon>



**SCMS**

School of Engineering & Technology

On Tue, Jun 26, 2018 at 6:54 PM, International Affairs, DIU <[int@daffodilvarsity.edu.bd](mailto:int@daffodilvarsity.edu.bd)> wrote:

Dear Dr. Varun

Thank you very much for the agreement final copy. It's fine

May I request you to sign the agreement and send the copies to me either scan copy in my email or 2 original copies in my address given in my email signature

- *With best regards*

**Syed Raihan-UI-Islam**

**Senior Administrative Officer, International Affairs**  
**Daffodil International University**

102/1, Shukrabad, Dhanmondi, Dhaka-1207, Bangladesh.

Tel: **+88 02 9138234 (Ext: 237)** | Mob: **+88-01811458865**

WhatsApp/Viber/Wechat: **+88-01920012744**

On Tue, Jun 26, 2018 at 7:01 PM, Dr. Varun G Menon <[varunmenon@scmsgroup.org](mailto:varunmenon@scmsgroup.org)> wrote:

Dear Mr. Syed Raihan-UI-Islam,

Thank you for the collaboration with SCMS. Please see the attached MoU draft approved by our Vice Chairman. Please let me know the remaining procedures including the signing of the MoU.

Thanks and Regards,

**Dr. Varun G Menon**

Associate Professor-Computer Science Engineering

Exe. Officer-Corporate Relations & International Collaborations

SCMS School of Engineering and Technology

Kerala, India-683582

Office: +91-484-2450330 Mob: +91-8714504684

Web: <http://www.scmsgroup.org/sset/computer-science-engineering/dr-varun-g-menon>



**SCMS**

School of Engineering & Technology

On Mon, Jun 25, 2018 at 3:55 PM, International Affairs, DIU <[int@daffodilvarsity.edu.bd](mailto:int@daffodilvarsity.edu.bd)> wrote:

Dear Dr. Varun

Thank you so much for your email and letting us know the update.

- *With best regards*

**Syed Raihan-UI-Islam**

**Senior Administrative Officer, International Affairs**  
**Daffodil International University**

102/1, Shukrabad, Dhanmondi, Dhaka-1207, Bangladesh.

Tel: **+88 02 9138234 (Ext: 237)** | Mob: **+88-01811458865**

WhatsApp/Viber/Wechat: **+88-01920012744**

On Mon, Jun 25, 2018 at 4:14 PM, Dr. Varun G Menon <[varunmenon@scmsgroup.org](mailto:varunmenon@scmsgroup.org)> wrote:

Dear Mr. Syed Raihan-UI-Islam,

Thank you for the collaboration with SCMS. I have presented the MoU with the Vice Chairman for approval. Once the approval is obtained, I will send back the approved soft copy of the MoU.

I have discussed about the Short Term Internships for students from DIU at the Centre for Robotics, SCMS with the Director, Robotics Lab. He has promised to send me The Best Plan for DIU students within two days. I will send you the same at the earliest.

Thanks and Regards,

**Dr. Varun G Menon**

Associate Professor-Computer Science Engineering  
Exe. Officer-Corporate Relations & International Collaborations  
SCMS School of Engineering and Technology  
Kerala, India-683582  
Office: +91-484-2450330 Mob: +91-8714504684  
Web: <http://www.scmsgroup.org/sset/computer-science-engineering/dr-varun-g-menon>



On Sun, Jun 24, 2018 at 12:56 AM, Dr. Varun G Menon  
<[varunmenon@scmsgroup.org](mailto:varunmenon@scmsgroup.org)> wrote:

Dear Mr. Syed Raihan-UI-Islam,  
Thank you for the email. Will inform the Professor's in charge of the Cyber Security and Robotics research centers about the program plan.  
Will sent you the documents soon.

Have a Great Day.

Thanks and Regards,

**Dr. Varun G Menon**

Associate Professor-Computer Science Engineering  
Exe. Officer-Corporate Relations & International Collaborations  
SCMS School of Engineering and Technology  
Kerala, India-683582  
Office: +91-484-2450330 Mob: +91-8714504684  
Web: <http://www.scmsgroup.org/sset/computer-science-engineering/dr-varun-g-menon>



On Sun, Jun 24, 2018 at 12:17 AM, International Affairs, DIU  
<[int@daffodilvarsity.edu.bd](mailto:int@daffodilvarsity.edu.bd)> wrote:

Dear Dr, Varun

Thank you very much for your quick response.

It would be great if you can share any proposal or program plan with all details, course plan, costing etc of the Summer internships based on Cyber Security and Robotics so that we could check and show t our students for interest.

Hope to receive the agreement and the program proposals soon. Have a great day !

- With best regards

**Syed Raihan-UI-Islam**

**Senior Administrative Officer, International Affairs**  
**Daffodil International University**

102/1, Shukrabad, Dhanmondi, Dhaka-1207, Bangladesh.

Tel: +88 02 9138234 (Ext: 237) | Mob: +88-01811458865

WhatsApp/Viber/Wechat: +88-01920012744

On Sun, Jun 24, 2018 at 12:35 AM, Dr. Varun G Menon

<[varunmenon@scmsgroup.org](mailto:varunmenon@scmsgroup.org)> wrote:

Dear Mr. Syed Raihan-UI-Islam,

Thank you for the information about Daffodil International University. Will complete the agreement copy and send you at the earliest.

We have 5 active research groups in our Engineering College that include Centre for Robotics, Centre for Cyber Security, Hydrodynamics and Computational Fluid Dynamics, Antennas and Radiation, Centre for Sustainable Water Technology and Management. Students from your University can do summer internships and short term projects with these project groups.

Besides we also have one of the leading Management Institute in India and also Biotechnology Research Centre.

Thank you for the collaboration. Will send you the document soon.

Regards,

**Dr. Varun G Menon**

Associate Professor-Computer Science Engineering

Exe. Officer-Corporate Relations & International Collaborations

SCMS School of Engineering and Technology

Kerala, India-683582

Office: +91-484-2450330 Mob: +91-8714504684

Web: <http://www.scmsgroup.org/sset/computer-science-engineering/dr-varun-g-menon>



**SCMS**

School of Engineering & Technology

On Sat, Jun 23, 2018 at 6:42 PM, International Affairs, DIU

<[int@daffodilvarsity.edu.bd](mailto:int@daffodilvarsity.edu.bd)> wrote:

Dear Dr. Varun G Menon,

**Greetings from DIU!**

**Thanks for your email and showing interest in the academic partnership. Yes, we can collaborate in the areas of student exchange programs, faculty exchange programs, summer school research collaborations, joint seminars and conferences.**

**I have attached here the sample agreement copy of DIU, Could you please check and fill it with your information. Besides, I have attached here the fact sheet of DIU where you can check our common details and department.**

**Your CSE, ECE and EEE Department can be a good prospect between both universities. Let us know your observation**

**Looking forward to hearing from you soon.**

*- With best regards*

**Syed Raihan-UI-Islam**

**Senior Administrative Officer, International Affairs**

**Daffodil International University**

102/1, Shukrabad, Dhanmondi, Dhaka-1207, Bangladesh.

Tel: **+88 02 9138234 (Ext: 237)** | Mob: **+88-01811458865**  
WhatsApp/Viber/Wechat: **+88-01920012744**

Respected Mr. Salahuddin Morsalin

Thank you for your time and consideration. Let me introduce as Dr. Varun G Menon, in charge of International Collaborations at SCMS Group of Educational Institutions, India.

We are interested in having academic collaboration with Daffodil International University. Collaboration could be in the areas of student exchange programs, faculty exchange programs, research collaborations, joint seminars and conferences.

We have a dedicate team of faculty and students working in areas like Robotics, Brain Signal Analysis, Computational fluid dynamics, Water Quality Monitoring and Assessment, Limnology, Water Audit, Environmental Remote Sensing , Android Malware Analysis. Research collaborations in these areas is another possibility.

We have academic collaborations with leading international universities like Vrije University-Brussels, Furtwangen University-Germany, University of Applied Sciences Ravensburg Weingarten-Germany, Shimane University-Japan and more.

**Please let me know if we could discuss and take forward this initiative.**

For your information we are the No 1 ranked private educational institutions in the state. You can find more information about our institutions in [www.scmsgroup.org](http://www.scmsgroup.org) and about out Engineering Institute in [www.scmsgroup.org/sset/](http://www.scmsgroup.org/sset/)

Have a Great Day.

Thanks and Regards,

**Dr. Varun G Menon**

Associate Professor-Computer Science Engineering  
Exe. Officer-Corporate Relations & International  
Collaborations

SCMS School of Engineering and Technology  
Kerala, India-683582

Office: +91-484-2450330 Mob: +91-8714504684

Web: <http://www.scmsgroup.org/sset/computer-science-engineering/dr-varun-g-menon>



**SCMS**  
School of Engineering & Technology



Thanks and Regards,

**Dr. Varun G Menon**

Associate Professor-Computer Science Engineering  
Exe. Officer-Corporate Relations & International Collaborations  
SCMS School of Engineering and Technology  
Kerala, India-683582  
Office: +91-484-2450330 Mob: +91-8714504684  
Web: <http://www.scmsgroup.org/sset/computer-science-engineering/dr-varun-g-menon>



**SCMS**  
School of Engineering & Technology

--

Thanks and Regards,

**Dr. Varun G Menon**

Associate Professor-Computer Science Engineering  
Exe. Officer-Corporate Relations & International Collaborations  
SCMS School of Engineering and Technology  
Kerala, India-683582  
Office: +91-484-2450330 Mob: +91-8714504684  
Web: <http://www.scmsgroup.org/sset/computer-science-engineering/dr-varun-g-menon>



**SCMS**  
School of Engineering & Technology

--

Thanks and Regards,

**Dr. Varun G Menon**

Associate Professor-Computer Science Engineering  
Exe. Officer-Corporate Relations & International Collaborations  
SCMS School of Engineering and Technology  
Kerala, India-683582  
Office: +91-484-2450330 Mob: +91-8714504684  
Web: <http://www.scmsgroup.org/sset/computer-science-engineering/dr-varun-g-menon>



**SCMS**  
School of Engineering & Technology

**International Affairs, DIU** <int@daffodilvarsity.edu.bd> Fri, Jul 13, 2018 at 1:21 PM  
To: "Dr. Varun G Menon" <varunmenon@scmsgroup.org>  
Cc: "Office of the International Affairs, DIU" <mobility@daffodilvarsity.edu.bd>, Scholarship News <scholarship@daffodilvarsity.edu.bd>, "International, DIU" <international@daffodilvarsity.edu.bd>, Emran Hossain <emran@daffodilvarsity.edu.bd>, "VC Office-2, DIU" <vcoffice2@daffodilvarsity.edu.bd>, Pramod <pramod@scmsgroup.org>, Anupama COK <anupama@scmsgroup.org>

Dear Dr. Varun

Yes we will arrange pick and drop for you and your Vice Chairman

- *With best regards*

**Syed Raihan-UI-Islam**

**Senior Administrative Officer, International Affairs**

**Daffodil International University**

102/1, Shukrabad, Dhanmondi, Dhaka-1207, Bangladesh.

Tel: **+88 02 9138234 (Ext: 237)** | Mob: **+88-01811458865**

WhatsApp/Viber/Wechat: **+88-01920012744**

On Thu, Jul 12, 2018 at 9:58 PM, Dr. Varun G Menon <varunmenon@scmsgroup.org> wrote:

Dear Mr. Syed Raihan-UI-Islam,

Thank you for the collaboration with SCMS.

Kindly see below the details of hotel reserved by us

**Hotel Name: Best Western B/W La Vinci Hotel**

**Address: 54, Kawran Bazar, Dhaka, Bangladesh 1215**

Please let me know if you would be arranging a pick up from the hotel to the DIU campus. We could start at 1.30 pm from the hotel to the DIU campus for the visit and signing of the MoU.

Thanks and Regards,

**Dr. Varun G Menon**

Associate Professor & Head of International Relations

SCMS Group of Educational Institutions

Cochin, Kerala, India-683106

Office: +91-484-2450330 Mob: +91-8714504684

Web: <http://www.scmsgroup.org>



**SCMS**

GROUP OF EDUCATIONAL INSTITUTIONS

On Mon, Jul 9, 2018 at 10:58 AM, International Affairs, DIU <int@daffodilvarsity.edu.bd> wrote:

Dear Dr. Varun,

Here is the address that i already gave you in whatsapp:

[Daffodil International University](#)  
102/1, Shukrabad, Dhanmondi, Dhaka-1207  
Bangladesh

some hotels nearby our campus:

<http://www.ambalainn.com>

<https://www.panpacific.com/en/hotels-and-resorts/pp-dhaka.html>

- *With best regards*

**Syed Raihan-UI-Islam**

**Senior Administrative Officer, International Affairs**  
**Daffodil International University**  
 102/1, Shukrabad, Dhanmondi, Dhaka-1207, Bangladesh.  
 Tel: **+88 02 9138234 (Ext: 237)** | Mob: **+88-01811458865**  
 WhatsApp/Viber/Wechat: **+88-01920012744**

On Thu, Jul 5, 2018 at 5:25 PM, Dr. Varun G Menon <[varunmenon@scmsgroup.org](mailto:varunmenon@scmsgroup.org)> wrote:

Dear Mr. Syed Raihan-UI-Islam,

Thank you for the collaboration with SCMS. Please let us know the campus address of DIU where the visit and MoU signing ceremony is planned so that we could arrange the stay in a hotel near the campus. We could see multiple campuses of DIU in the website. It would also be great if you could give the names of few good hotels near your campus.

Thanks and Regards,

**Dr. Varun G Menon**

Associate Professor, Computer Science Engineering  
 Exe. Officer, Corporate Relations & International Collaborations  
 SCMS School of Engineering and Technology  
 Kerala, India-683582  
 Office: +91-484-2450330 Mob: +91-8714504684  
 Web: <http://www.scmsgroup.org/sset/computer-science-engineering/dr-varun-g-menon>



**SCMS**  
 School of Engineering & Technology

On Tue, Jul 3, 2018 at 5:04 PM, International Affairs, DIU <[int@daffodilvarsity.edu.bd](mailto:int@daffodilvarsity.edu.bd)> wrote:

Dear Dr. Varun

Yes Confirm so far. Thank You

- With best regards

**Syed Raihan-UI-Islam**

**Senior Administrative Officer, International Affairs**  
**Daffodil International University**  
 102/1, Shukrabad, Dhanmondi, Dhaka-1207, Bangladesh.  
 Tel: **+88 02 9138234 (Ext: 237)** | Mob: **+88-01811458865**  
 WhatsApp/Viber/Wechat: **+88-01920012744**

On Tue, Jul 3, 2018 at 3:57 AM, Dr. Varun G Menon <[varunmenon@scmsgroup.org](mailto:varunmenon@scmsgroup.org)> wrote:

Dear Mr. Syed Raihan-UI-Islam

Thank you for the valuable time. Please confirm the schedule as discussed and agreed earlier. No need to change the schedule. Our flight is scheduled only in the night.

- MoU Signing Ceremony and discussion session on **25th July 2018** from **3PM to 5PM**
- Visit to DIU Permanent Campus and Lunch on the on that day **9AM to 2PM**

Thanks and Regards,

**Dr. Varun G Menon**

Associate Professor, Computer Science Engineering  
 Exe. Officer, Corporate Relations & International Collaborations  
 SCMS School of Engineering and Technology  
 Kerala, India-683582  
 Office: +91-484-2450330 Mob: +91-8714504684  
 Web: <http://www.scmsgroup.org/sset/computer-science-engineering/dr-varun-g-menon>



**SCMS**  
 School of Engineering & Technology

On Sun, Jul 1, 2018 at 12:09 PM, Dr. Varun G Menon <[varunmenon@scmsgroup.org](mailto:varunmenon@scmsgroup.org)> wrote:

Dear Mr. Syed Raihan-UI-Islam,

Please let me know if you can arrange the MoU signing ceremony and discussion on collaboration at DIU on **25th July morning** as we have flight back to India in the evening.

Thank you,

**Dr. Varun G Menon**

Associate Professor-Computer Science Engineering  
Exe. Officer-Corporate Relations & International Collaborations  
SCMS School of Engineering and Technology  
Kerala, India-683582  
Office: +91-484-2450330 Mob: +91-8714504684  
Web: <http://www.scmsgroup.org/sset/computer-science-engineering/dr-varun-g-memon>



**SCMS**  
School of Engineering & Technology

On Thu, Jun 28, 2018 at 1:32 PM, Dr. Varun G Menon <[varunmenon@scmsgroup.org](mailto:varunmenon@scmsgroup.org)> wrote:

Dear Mr. Syed Raihan-UI-Islam,

Thank you for the invitation letter. Looking forward to the meeting. Will update our schedule once we confirm the flight tickets.

Thanks and Regards,

**Dr. Varun G Menon**

Associate Professor-Computer Science Engineering  
Exe. Officer-Corporate Relations & International Collaborations  
SCMS School of Engineering and Technology  
Kerala, India-683582  
Office: +91-484-2450330 Mob: +91-8714504684  
Web: <http://www.scmsgroup.org/sset/computer-science-engineering/dr-varun-g-memon>



**SCMS**  
School of Engineering & Technology

On Thu, Jun 28, 2018 at 1:09 PM, International Affairs, DIU <[int@daffodilvarsity.edu.bd](mailto:int@daffodilvarsity.edu.bd)> wrote:

Dear Dr. Varun

Please find the attached letter of Invitation for both of you to visit us for the purpose of the meeting and signing the agreement.

- With best regards

**Syed Raihan-UI-Islam**

**Senior Administrative Officer, International Affairs**  
**Daffodil International University**  
102/1, Shukrabad, Dhanmondi, Dhaka-1207, Bangladesh.  
Tel: **+88 02 9138234 (Ext: 237)** | Mob: **+88-01811458865**  
WhatsApp/Viber/Wechat: **+88-01920012744**

On Thu, Jun 28, 2018 at 8:20 AM, Dr. Varun G Menon <[varunmenon@scmsgroup.org](mailto:varunmenon@scmsgroup.org)> wrote:

Dear Mr. Syed Raihan-UI-Islam,

Please see below the details of members visiting DIU on 25th July 2018. Please send us the **invitation letter for the Visa** based on this information.

**Names**

Prof. **PRAMOD PRATHAPACHANDRAN THEVANNOOR**, Vice Chairman, SCMS Group of Educational Institutions.

Dr. **VARUN GIRIJAN MENON**, Associate Professor and International Relations in-charge, SCMS Group of Educational Institutions.

**Address**

SCMS Group of Educational Institutions  
SCMS Campus, Prathap Nagar  
Muttom, Aluva  
Cochin – 683 106, Kerala, INDIA

Let me know any further information required.

Thanks and Regards,

**Dr. Varun G Menon**

Associate Professor-Computer Science Engineering  
Exe. Officer-Corporate Relations & International Collaborations  
SCMS School of Engineering and Technology  
Kerala, India-683582  
Office: +91-484-2450330 Mob: +91-8714504684  
Web: <http://www.scmsgroup.org/sset/computer-science-engineering/dr-varun-g-menon>



**SCMS**  
School of Engineering & Technology

On Wed, Jun 27, 2018 at 11:48 AM, International Affairs, DIU <[int@daffodilvarsity.edu.bd](mailto:int@daffodilvarsity.edu.bd)> wrote:  
Dear Dr. Varun

Thanks. I am looking forward.

- With best regards

**Syed Raihan-UI-Islam**

**Senior Administrative Officer, International Affairs**

**Daffodil International University**

102/1, Shukrabad, Dhanmondi, Dhaka-1207, Bangladesh.

Tel: **+88 02 9138234 (Ext: 237)** | Mob: **+88-01811458865**

WhatsApp/Viber/Wechat: **+88-01920012744**

On Wed, Jun 27, 2018 at 12:15 PM, Dr. Varun G Menon <[varunmenon@scmsgroup.org](mailto:varunmenon@scmsgroup.org)> wrote:

Dear Mr. Syed Raihan-UI-Islam,

Thank you for the information. We will have the visit on 25th July. We will send the details of the members visiting the DIU campus at the earliest.

Regards

Varun

On Wednesday, June 27, 2018, International Affairs, DIU <[int@daffodilvarsity.edu.bd](mailto:int@daffodilvarsity.edu.bd)> wrote:

Dear Dr. Varun,

I have discussed with the Office of the Vice Chancellor

We can arrange the MoU Signing Ceremony and discussion session on **25 July 2018** from **3PM to 5PM**

We can also arrange to visit our Permanent Campus and Lunch on the on that day 9AM to 2PM too.

Let us know if the time and date is convenient for your visit

Looking forward to hearing from you.

- With best regards

**Syed Raihan-UI-Islam**

**Senior Administrative Officer, International Affairs**

**Daffodil International University**

102/1, Shukrabad, Dhanmondi, Dhaka-1207, Bangladesh.

Tel: **+88 02 9138234 (Ext: 237)** | Mob: **+88-01811458865**

WhatsApp/Viber/Wechat: **+88-01920012744**

On Wed, Jun 27, 2018 at 11:18 AM, Dr. Varun G Menon <[varunmenon@scmsgroup.org](mailto:varunmenon@scmsgroup.org)> wrote:

Dear Mr. Syed Raihan-UI-Islam,

Can we have the visit between July 24 and 27. Our Vice Chairman is traveling on other dates in July.

Please let me know.

Varun

On Wednesday, June 27, 2018, International Affairs, DIU <[int@daffodilvarsity.edu.bd](mailto:int@daffodilvarsity.edu.bd)> wrote:

Dear Dr. Varun

Can we shift it to the next week I mean in between 15 to 20 July?

- With best regards

**Syed Raihan-UI-Islam**

**Senior Administrative Officer, International Affairs**

**Daffodil International University**

102/1, Shukrabad, Dhanmondi, Dhaka-1207, Bangladesh.

Tel: **+88 02 9138234 (Ext: 237)** | Mob: **+88-01811458865**

WhatsApp/Viber/Wechat: **+88-01920012744**

On Wed, Jun 27, 2018 at 10:55 AM, Dr. Varun G Menon <[varunmenon@scmsgroup.org](mailto:varunmenon@scmsgroup.org)> wrote:

Dear Mr. Syed Raihan-UI-Islam,

Thank you for the message. We would like to visit DIU between 10th and 14th July. Please let us know if the date is convenient at your end. Also it would be great if you could send us an Invitation letter which could be produced for the Visa.

Let me know any further details required.

Varun

On Tuesday, June 26, 2018, International Affairs, DIU <[int@daffodilvarsity.edu.bd](mailto:int@daffodilvarsity.edu.bd)> wrote:

Dear Dr. Varun

That is a good idea. Let us know your possible dates to visit us and sign the agreement between both of the universities.

- With best regards

**Syed Raihan-UI-Islam**

**Senior Administrative Officer, International Affairs**

**Daffodil International University**

102/1, Shukrabad, Dhanmondi, Dhaka-1207, Bangladesh.

Tel: **+88 02 9138234 (Ext: 237)** | Mob: **+88-01811458865**

WhatsApp/Viber/Wechat: **+88-01920012744**

On Tue, Jun 26, 2018 at 10:38 PM, Dr. Varun G Menon <[varunmenon@scmsgroup.org](mailto:varunmenon@scmsgroup.org)> wrote:

Dear Mr. Syed Raihan-UI-Islam,

Thank you for the collaboration with SCMS. We would like to visit the DIU campus on a favorable date and would like to sign the MoU with the Vice Chancellor at DIU.

We would be more than happy to host the DIU team with Vice Chancellor in our campus in future. Please let me know your thoughts.

Thanks and Regards,

**Dr. Varun G Menon**

Associate Professor-Computer Science Engineering  
Exe. Officer-Corporate Relations & International Collaborations  
SCMS School of Engineering and Technology  
Kerala, India-683582  
Office: +91-484-2450330 Mob: +91-8714504684  
Web: <http://www.scmsgroup.org/sset/computer-science-engineering/dr-varun-g-menon>



**SCMS**  
School of Engineering & Technology

On Tue, Jun 26, 2018 at 6:54 PM, International Affairs, DIU  
<[int@daffodilvarsity.edu.bd](mailto:int@daffodilvarsity.edu.bd)> wrote:

Dear Dr. Varun

Thank you very much for the agreement final copy. It's fine

May I request you to sign the agreement and send the copies to me either scan copy in my email or 2 original copies in my address given in my email signature

- With best regards

**Syed Raihan-UI-Islam**

**Senior Administrative Officer, International Affairs**  
**Daffodil International University**

102/1, Shukrabad, Dhanmondi, Dhaka-1207, Bangladesh.

Tel: **+88 02 9138234 (Ext: 237)** | Mob: **+88-01811458865**

WhatsApp/Viber/Wechat: **+88-01920012744**

On Tue, Jun 26, 2018 at 7:01 PM, Dr. Varun G Menon  
<[varunmenon@scmsgroup.org](mailto:varunmenon@scmsgroup.org)> wrote:

Dear Mr. Syed Raihan-UI-Islam,

Thank you for the collaboration with SCMS. Please see the attached MoU draft approved by our Vice Chairman. Please let me know the remaining procedures including the signing of the MoU.

Thanks and Regards,

**Dr. Varun G Menon**

Associate Professor-Computer Science Engineering  
Exe. Officer-Corporate Relations & International Collaborations  
SCMS School of Engineering and Technology  
Kerala, India-683582

Office: +91-484-2450330 Mob: +91-8714504684

Web: <http://www.scmsgroup.org/sset/computer-science-engineering/dr-varun-g-menon>



**SCMS**  
School of Engineering & Technology

On Mon, Jun 25, 2018 at 3:55 PM, International Affairs, DIU  
<[int@daffodilvarsity.edu.bd](mailto:int@daffodilvarsity.edu.bd)> wrote:

Dear Dr. Varun

Thank you so much for your email and letting us know the update.

- With best regards

**Syed Raihan-UI-Islam**

**Senior Administrative Officer, International Affairs**

**Daffodil International University**

102/1, Shukrabad, Dhanmondi, Dhaka-1207, Bangladesh.

Tel: +88 02 9138234 (Ext: 237) | Mob: +88-01811458865

WhatsApp/Viber/Wechat: +88-01920012744

On Mon, Jun 25, 2018 at 4:14 PM, Dr. Varun G Menon

<[varunmenon@scmsgroup.org](mailto:varunmenon@scmsgroup.org)> wrote:

Dear Mr. Syed Raihan-UI-Islam,

Thank you for the collaboration with SCMS. I have presented the MoU with the Vice Chairman for approval. Once the approval is obtained, I will send back the approved soft copy of the MoU.

I have discussed about the Short Term Internships for students from DIU at the Centre for Robotics, SCMS with the Director, Robotics Lab. He has promised to send me The Best Plan for DIU students within two days. I will send you the same at the earliest.

Thanks and Regards,

**Dr. Varun G Menon**

Associate Professor-Computer Science Engineering

Exe. Officer-Corporate Relations & International Collaborations

SCMS School of Engineering and Technology

Kerala, India-683582

Office: +91-484-2450330 Mob: +91-8714504684

Web: <http://www.scmsgroup.org/sset/computer-science-engineering/dr-varun-g-menon>



**SCMS**

School of Engineering & Technology

On Sun, Jun 24, 2018 at 12:56 AM, Dr. Varun G Menon

<[varunmenon@scmsgroup.org](mailto:varunmenon@scmsgroup.org)> wrote:

Dear Mr. Syed Raihan-UI-Islam,

Thank you for the email. Will inform the Professor's in charge of the Cyber Security and Robotics research centers about the program plan. Will sent you the documents soon.

Have a Great Day.

Thanks and Regards,

**Dr. Varun G Menon**

Associate Professor-Computer Science Engineering

Exe. Officer-Corporate Relations & International Collaborations

SCMS School of Engineering and Technology

Kerala, India-683582

Office: +91-484-2450330 Mob: +91-8714504684

Web: <http://www.scmsgroup.org/sset/computer-science-engineering/dr-varun-g-menon>



**SCMS**

School of Engineering & Technology

On Sun, Jun 24, 2018 at 12:17 AM, International Affairs, DIU

<[int@daffodilvarsity.edu.bd](mailto:int@daffodilvarsity.edu.bd)> wrote:

Dear Dr, Varun

Thank you very much for your quick response.



It would be great if you can share any proposal or program plan with all details, course plan, costing etc of the Summer internships based on Cyber Security and Robotics so that we could check and show t our students for interest.

Hope to receive the agreement and the program proposals soon. Have a great day !

- With best regards

**Syed Raihan-UI-Islam**

**Senior Administrative Officer, International Affairs**

**Daffodil International University**

102/1, Shukrabad, Dhanmondi, Dhaka-1207, Bangladesh.

Tel: **+88 02 9138234 (Ext: 237)** | Mob: **+88-01811458865**

WhatsApp/Viber/Wechat: **+88-01920012744**

On Sun, Jun 24, 2018 at 12:35 AM, Dr. Varun G Menon

<[varunmenon@scmsgroup.org](mailto:varunmenon@scmsgroup.org)> wrote:

Dear Mr. Syed Raihan-UI-Islam,

Thank you for the information about Daffodil International University. Will complete the agreement copy and send you at the earliest.

We have 5 active research groups in our Engineering College that include Centre for Robotics, Centre for Cyber Security, Hydrodynamics and Computational Fluid Dynamics, Antennas and Radiation, Centre for Sustainable Water Technology and Management. Students from your University can do summer internships and short term projects with these project groups.

Besides we also have one of the leading Management Institute in India and also Biotechnology Research Centre.

Thank you for the collaboration. Will send you the document soon.

Regards,

**Dr. Varun G Menon**

Associate Professor-Computer Science Engineering

Exe. Officer-Corporate Relations & International Collaborations

SCMS School of Engineering and Technology

Kerala, India-683582

Office: +91-484-2450330 Mob: +91-8714504684

Web: <http://www.scmsgroup.org/sset/computer-science-engineering/dr-varun-g-menon>



**SCMS**

School of Engineering & Technology

On Sat, Jun 23, 2018 at 6:42 PM, International Affairs, DIU

<[int@daffodilvarsity.edu.bd](mailto:int@daffodilvarsity.edu.bd)> wrote:

**Dear Dr. Varun G Menon,**

**Greetings from DIU!**

**Thanks for your email and showing interest in the academic partnership. Yes, we can Ccollaborate in the areas of student exchange programs, faculty exchange programs, summer school research collaborations, joint seminars and conferences.**

I have attached here the sample agreement copy of DIU, Could you please check and fill it with your information. Besides, I have attached here the fact sheet of DIU where you can check our common details and department.

Your CSE, ECE and EEE Department can be a good prospect between both universities. Let us know your observation

Looking forward to hearing from you soon.

- With best regards

**Syed Raihan-UI-Islam**

**Senior Administrative Officer, International Affairs**  
**Daffodil International University**

102/1, Shukrabad, Dhanmondi, Dhaka-1207, Bangladesh.

Tel: +88 02 9138234 (Ext: 237) | Mob: +88-01811458865

WhatsApp/Viber/Wechat: +88-01920012744

Respected Mr. Salahuddin Morsalin

Thank you for your time and consideration. Let me introduce as Dr. Varun G Menon, in charge of International Collaborations at SCMS Group of Educational Institutions, India.

We are interested in having academic collaboration with Daffodil International University. Collaboration could be in the areas of student exchange programs, faculty exchange programs, research collaborations, joint seminars and conferences.

We have a dedicate team of faculty and students working in areas like Robotics, Brain Signal Analysis, Computational fluid dynamics . Water Quality Monitoring and Assessment, Limnology, Water Audit, Environmental Remote Sensing , Android Malware Analysis . Research collaborations in these areas is another possibility.

We have academic collaborations with leading international universities like Vrije University-Brussels, Furtwangen University-Germany, University of Applied Sciences Ravensburg Weingarten-Germany, Shimane University-Japan and more.

**Please let me know if we could discuss and take forward this initiative.**

For your information we are the No 1 ranked private educational institutions in the state. You can find more information about our institutions in [www.scmsgroup.org](http://www.scmsgroup.org) and about our Engineering Institute in [www.scmsgroup.org/sset/](http://www.scmsgroup.org/sset/)

Have a Great Day.

Thanks and Regards,

**Dr. Varun G Menon**

Associate Professor-Computer Science Engineering  
Exe. Officer-Corporate Relations & International  
Collaborations

SCMS School of Engineering and Technology

Kerala, India-683582

Office: +91-484-2450330 Mob: +91-8714504684

Web: <http://www.scmsgroup.org/sset/computer-science-engineering/dr-varun-g-menon>



**SCMS**

School of Engineering & Technology

--  
Thanks and Regards,

**Dr. Varun G Menon**

Associate Professor-Computer Science Engineering  
Exe. Officer-Corporate Relations & International Collaborations  
SCMS School of Engineering and Technology  
Kerala, India-683582  
Office: +91-484-2450330 Mob: +91-8714504684  
Web: <http://www.scmsgroup.org/sset/computer-science-engineering/dr-varun-g-menon>



--  
Thanks and Regards,

**Dr. Varun G Menon**

Associate Professor-Computer Science Engineering  
Exe. Officer-Corporate Relations & International Collaborations  
SCMS School of Engineering and Technology  
Kerala, India-683582  
Office: +91-484-2450330 Mob: +91-8714504684  
Web: <http://www.scmsgroup.org/sset/computer-science-engineering/dr-varun-g-menon>



--  
Thanks and Regards,

**Dr. Varun G Menon**

Associate Professor-Computer Science Engineering  
Exe. Officer-Corporate Relations & International Collaborations  
SCMS School of Engineering and Technology  
Kerala, India-683582  
Office: +91-484-2450330 Mob: +91-8714504684  
Web: <http://www.scmsgroup.org/sset/computer-science-engineering/dr-varun-g-menon>



**SCMS**  
School of Engineering & Technology

**International Affairs, DIU** <int@daffodilvarsity.edu.bd>

Sun, Aug 19, 2018 at 3:13 PM

To: "Dr. Varun G Menon" <varunmenon@scmsgroup.org>

Cc: Emran Hossain <emran@daffodilvarsity.edu.bd>, "International, DIU" <international@daffodilvarsity.edu.bd>, "Office of the International Affairs, DIU" <mobility@daffodilvarsity.edu.bd>, Scholarship News <scholarship@daffodilvarsity.edu.bd>, Pramod <pramod@scmsgroup.org>, Anupama COK <anupama@scmsgroup.org>, Kazi Mesbah Ur Rahman <oia@daffodilvarsity.edu.bd>

Dear Dr. Varun,

Greetings!

Hope you are doing well. We thank you and honorable Vice Chairman for visiting us and sign the agreement. Let us work and plan together to activate the partnership soon.

So far I remember you have some program plans that you were working to send me. Once it's ready please do send us, At the same time, we invite your faculty member to come and teach for short term period as exchange faculty. let us know the possibility

Here I attached some news coverage that published in different national daily newspapers (Both Bangla and English) about the agreement signing between DIU and SCMS group.

Have a great day!

- *With best regards*

**Syed Raihan-UI-Islam**

**Senior Administrative Officer, International Affairs**

**Daffodil International University**

102/1, Shukrabad, Dhanmondi, Dhaka-1207, Bangladesh.

Tel: **+88 02 9138234 (Ext: 237)** | Mob: **+88-01811458865**

WhatsApp/Viber/Wechat: **+88-01920012744**

On Fri, Jul 13, 2018 at 1:51 PM, International Affairs, DIU <int@daffodilvarsity.edu.bd> wrote:

Dear Dr. Varun

Yes we will arrange pick and drop for you and your Vice Chairman

- *With best regards*

**Syed Raihan-UI-Islam**

**Senior Administrative Officer, International Affairs**

**Daffodil International University**

102/1, Shukrabad, Dhanmondi, Dhaka-1207, Bangladesh.

Tel: **+88 02 9138234 (Ext: 237)** | Mob: **+88-01811458865**

WhatsApp/Viber/Wechat: **+88-01920012744**

On Thu, Jul 12, 2018 at 9:58 PM, Dr. Varun G Menon <varunmenon@scmsgroup.org> wrote:

Dear Mr. Syed Raihan-UI-Islam,

Thank you for the collaboration with SCMS.

Kindly see below the details of hotel reserved by us

**Hotel Name: Best Western B/W La Vinci Hotel**

**Address: 54, Kawran Bazar, Dhaka, Bangladesh 1215**

Please let me know if you would be arranging a pick up from the hotel to the DIU campus. We could start at 1.30 pm from the hotel to the DIU campus for the visit and signing of the MoU.

Thanks and Regards,

**Dr. Varun G Menon**

Associate Professor & Head of International Relations

SCMS Group of Educational Institutions

Cochin, Kerala, India-683106

Office: +91-484-2450330 Mob: +91-8714504684

Web: <http://www.scmsgroup.org>



On Mon, Jul 9, 2018 at 10:58 AM, International Affairs, DIU <[int@daffodilvarsity.edu.bd](mailto:int@daffodilvarsity.edu.bd)> wrote:

Dear Dr. Varun,

Here is the address that i already gave you in whatsapp:

[Daffodil International University](#)  
102/1, Shukrabad, Dhanmondi, Dhaka-1207  
Bangladesh

some hotels nearby our campus:

<http://www.ambalainn.com>

<https://www.panpacific.com/en/hotels-and-resorts/pp-dhaka.html>

- With best regards

**Syed Raihan-UI-Islam**

**Senior Administrative Officer, International Affairs**

**Daffodil International University**

102/1, Shukrabad, Dhanmondi, Dhaka-1207, Bangladesh.

Tel: **+88 02 9138234 (Ext: 237)** | Mob: **+88-01811458865**

WhatsApp/Viber/Wechat: **+88-01920012744**

On Thu, Jul 5, 2018 at 5:25 PM, Dr. Varun G Menon <[varunmenon@scmsgroup.org](mailto:varunmenon@scmsgroup.org)> wrote:

Dear Mr. Syed Raihan-UI-Islam,

Thank you for the collaboration with SCMS. Please let us know the campus address of DIU where the visit and MoU signing ceremony is planned so that we could arrange the stay in a hotel near the campus. We could see multiple campuses of DIU in the website. It would also be great if you could give the names of few good hotels near your campus.

Thanks and Regards,

**Dr. Varun G Menon**

Associate Professor, Computer Science Engineering

Exe. Officer, Corporate Relations & International Collaborations

SCMS School of Engineering and Technology

Kerala, India-683582

Office: +91-484-2450330 Mob: +91-8714504684

Web: <http://www.scmsgroup.org/sset/computer-science-engineering/dr-varun-g-menon>



**SCMS**  
School of Engineering & Technology

On Tue, Jul 3, 2018 at 5:04 PM, International Affairs, DIU <[int@daffodilvarsity.edu.bd](mailto:int@daffodilvarsity.edu.bd)> wrote:  
Dear Dr. Varun

Yes Confirm so far. Thank You

- With best regards

**Syed Raihan-UI-Islam**

**Senior Administrative Officer, International Affairs**  
**Daffodil International University**

102/1, Shukrabad, Dhanmondi, Dhaka-1207, Bangladesh.

Tel: **+88 02 9138234 (Ext: 237)** | Mob: **+88-01811458865**

WhatsApp/Viber/Wechat: **+88-01920012744**

On Tue, Jul 3, 2018 at 3:57 AM, Dr. Varun G Menon <[varunmenon@scmsgroup.org](mailto:varunmenon@scmsgroup.org)> wrote:  
Dear Mr. Syed Raihan-UI-Islam

Thank you for the valuable time. Please confirm the schedule as discussed and agreed earlier. No need to change the schedule. Our flight is scheduled only in the night.

- MoU Signing Ceremony and discussion session on **25th July 2018** from **3PM to 5PM**
- Visit to DIU Permanent Campus and Lunch on the on that day **9AM to 2PM**

Thanks and Regards,

**Dr. Varun G Menon**

Associate Professor, Computer Science Engineering

Exe. Officer, Corporate Relations & International Collaborations

SCMS School of Engineering and Technology

Kerala, India-683582

Office: +91-484-2450330 Mob: +91-8714504684

Web: <http://www.scmsgroup.org/sset/computer-science-engineering/dr-varun-g-menon>



**SCMS**  
School of Engineering & Technology

On Sun, Jul 1, 2018 at 12:09 PM, Dr. Varun G Menon <[varunmenon@scmsgroup.org](mailto:varunmenon@scmsgroup.org)> wrote:

Dear Mr. Syed Raihan-UI-Islam,

Please let me know if you can arrange the MoU signing ceremony and discussion on collaboration at DIU on **25th July morning** as we have flight back to India in the evening.

Thank you,

**Dr. Varun G Menon**

Associate Professor-Computer Science Engineering

Exe. Officer-Corporate Relations & International Collaborations

SCMS School of Engineering and Technology

Kerala, India-683582

Office: +91-484-2450330 Mob: +91-8714504684

Web: <http://www.scmsgroup.org/sset/computer-science-engineering/dr-varun-g-menon>



**SCMS**  
School of Engineering & Technology

On Thu, Jun 28, 2018 at 1:32 PM, Dr. Varun G Menon <[varunmenon@scmsgroup.org](mailto:varunmenon@scmsgroup.org)> wrote:

Dear Mr. Syed Raihan-UI-Islam,

Thank you for the invitation letter. Looking forward to the meeting. Will update our schedule once we confirm the flight tickets.

Thanks and Regards,

**Dr. Varun G Menon**

Associate Professor-Computer Science Engineering  
Exe. Officer-Corporate Relations & International Collaborations  
SCMS School of Engineering and Technology  
Kerala, India-683582  
Office: +91-484-2450330 Mob: +91-8714504684  
Web: <http://www.scmsgroup.org/sset/computer-science-engineering/dr-varun-g-menon>



**SCMS**  
School of Engineering & Technology

On Thu, Jun 28, 2018 at 1:09 PM, International Affairs, DIU <[int@daffodilvarsity.edu.bd](mailto:int@daffodilvarsity.edu.bd)> wrote:

Dear Dr. Varun

Please find the attached letter of Invitation for both of you to visit us for the purpose of the meeting and signing the agreement.

- *With best regards*

**Syed Raihan-UI-Islam**

**Senior Administrative Officer, International Affairs**  
**Daffodil International University**  
102/1, Shukrabad, Dhanmondi, Dhaka-1207, Bangladesh.  
Tel: **+88 02 9138234 (Ext: 237)** | Mob: **+88-01811458865**  
WhatsApp/Viber/Wechat: **+88-01920012744**

On Thu, Jun 28, 2018 at 8:20 AM, Dr. Varun G Menon <[varunmenon@scmsgroup.org](mailto:varunmenon@scmsgroup.org)> wrote:

Dear Mr. Syed Raihan-UI-Islam,

Please see below the details of members visiting DIU on 25th July 2018. Please send us the **invitation letter for the Visa** based on this information.

**Names**

Prof. **PRAMOD PRATHAPACHANDRAN THEVANNOOR**, Vice Chairman, SCMS Group of Educational Institutions.

Dr. **VARUN GIRIJAN MENON**, Associate Professor and International Relations in-charge, SCMS Group of Educational Institutions.

**Address**

SCMS Group of Educational Institutions  
SCMS Campus, Prathap Nagar  
Muttom, Aluva  
Cochin – 683 106, Kerala, INDIA

Let me know any further information required.

Thanks and Regards,

**Dr. Varun G Menon**

Associate Professor-Computer Science Engineering  
Exe. Officer-Corporate Relations & International Collaborations  
SCMS School of Engineering and Technology  
Kerala, India-683582  
Office: +91-484-2450330 Mob: +91-8714504684  
Web: <http://www.scmsgroup.org/sset/computer-science-engineering/dr-varun-g-menon>



**SCMS**  
School of Engineering & Technology

On Wed, Jun 27, 2018 at 11:48 AM, International Affairs, DIU <[int@daffodilvarsity.edu.bd](mailto:int@daffodilvarsity.edu.bd)> wrote:  
Dear Dr. Varun

Thanks. I am looking forward.

- With best regards

**Syed Raihan-UI-Islam**

**Senior Administrative Officer, International Affairs**

**Daffodil International University**

102/1, Shukrabad, Dhanmondi, Dhaka-1207, Bangladesh.

Tel: **+88 02 9138234 (Ext: 237)** | Mob: **+88-01811458865**

WhatsApp/Viber/Wechat: **+88-01920012744**

On Wed, Jun 27, 2018 at 12:15 PM, Dr. Varun G Menon <[varunmenon@scmsgroup.org](mailto:varunmenon@scmsgroup.org)> wrote:

Dear Mr. Syed Raihan-UI-Islam,

Thank you for the information. We will have the visit on 25th July. We will send the details of the members visiting the DIU campus at the earliest.

Regards

Varun

On Wednesday, June 27, 2018, International Affairs, DIU <[int@daffodilvarsity.edu.bd](mailto:int@daffodilvarsity.edu.bd)> wrote:

Dear Dr. Varun,

I have discussed with the Office of the Vice Chancellor

We can arrange the MoU Signing Ceremony and discussion session on **25 July 2018** from **3PM to 5PM**

We can also arrange to visit our Permanent Campus and Lunch on the on that day 9AM to 2PM too.

Let us know if the time and date is convenient for your visit

Looking forward to hearing from you.

- With best regards

**Syed Raihan-UI-Islam**

**Senior Administrative Officer, International Affairs**

**Daffodil International University**

102/1, Shukrabad, Dhanmondi, Dhaka-1207, Bangladesh.

Tel: **+88 02 9138234 (Ext: 237)** | Mob: **+88-01811458865**

WhatsApp/Viber/Wechat: **+88-01920012744**

On Wed, Jun 27, 2018 at 11:18 AM, Dr. Varun G Menon <[varunmenon@scmsgroup.org](mailto:varunmenon@scmsgroup.org)> wrote:

Dear Mr. Syed Raihan-UI-Islam,

Can we have the visit between July 24 and 27. Our Vice Chairman is traveling on other dates in July.

Please let me know.

Varun

On Wednesday, June 27, 2018, International Affairs, DIU <[int@daffodilvarsity.edu.bd](mailto:int@daffodilvarsity.edu.bd)> wrote:

Dear Dr. Varun



Can we shift it to the next week I mean in between 15 to 20 July?

- With best regards

**Syed Raihan-UI-Islam**

**Senior Administrative Officer, International Affairs**

**Daffodil International University**

102/1, Shukrabad, Dhanmondi, Dhaka-1207, Bangladesh.

Tel: **+88 02 9138234 (Ext: 237)** | Mob: **+88-01811458865**

WhatsApp/Viber/Wechat: **+88-01920012744**

On Wed, Jun 27, 2018 at 10:55 AM, Dr. Varun G Menon <[varunmenon@scmsgroup.org](mailto:varunmenon@scmsgroup.org)> wrote:

Dear Mr. Syed Raihan-UI-Islam,

Thank you for the message. We would like to visit DIU between 10th and 14th July. Please let us know if the date is convenient at your end. Also it would be great if you could send us an Invitation letter which could be produced for the Visa.

Let me know any further details required.

Varun

On Tuesday, June 26, 2018, International Affairs, DIU <[int@daffodilvarsity.edu.bd](mailto:int@daffodilvarsity.edu.bd)> wrote:

Dear Dr. Varun

That is a good idea. Let us know your possible dates to visit us and sign the agreement between both of the universities.

- With best regards

**Syed Raihan-UI-Islam**

**Senior Administrative Officer, International Affairs**

**Daffodil International University**

102/1, Shukrabad, Dhanmondi, Dhaka-1207, Bangladesh.

Tel: **+88 02 9138234 (Ext: 237)** | Mob: **+88-01811458865**

WhatsApp/Viber/Wechat: **+88-01920012744**

On Tue, Jun 26, 2018 at 10:38 PM, Dr. Varun G Menon <[varunmenon@scmsgroup.org](mailto:varunmenon@scmsgroup.org)> wrote:

Dear Mr. Syed Raihan-UI-Islam,

Thank you for the collaboration with SCMS. We would like to visit the DIU campus on a favorable date and would like to sign the MoU with the Vice Chancellor at DIU.

We would be more than happy to host the DIU team with Vice Chancellor in our campus in future. Please let me know your thoughts.

Thanks and Regards,

**Dr. Varun G Menon**

Associate Professor-Computer Science Engineering

Exe. Officer-Corporate Relations & International Collaborations

SCMS School of Engineering and Technology

Kerala, India-683582

Office: +91-484-2450330 Mob: +91-8714504684

Web: <http://www.scmsgroup.org/sset/computer-science-engineering/dr-varun-g-menon>



**SCMS**

School of Engineering & Technology

On Tue, Jun 26, 2018 at 6:54 PM, International Affairs, DIU <[int@daffodilvarsity.edu.bd](mailto:int@daffodilvarsity.edu.bd)> wrote:

Dear Dr. Varun

Thank you very much for the agreement final copy. It's fine

May I request you to sign the agreement and send the copies to me either scan copy in my email or 2 original copies in my address given in my email signature

- With best regards

**Syed Raihan-UI-Islam**

**Senior Administrative Officer, International Affairs**  
**Daffodil International University**

102/1, Shukrabad, Dhanmondi, Dhaka-1207, Bangladesh.

Tel: **+88 02 9138234 (Ext: 237)** | Mob: **+88-01811458865**

WhatsApp/Viber/Wechat: **+88-01920012744**

On Tue, Jun 26, 2018 at 7:01 PM, Dr. Varun G Menon

<[varunmenon@scmsgroup.org](mailto:varunmenon@scmsgroup.org)> wrote:

Dear Mr. Syed Raihan-UI-Islam,

Thank you for the collaboration with SCMS. Please see the attached MoU draft approved by our Vice Chairman. Please let me know the remaining procedures including the signing of the MoU.

Thanks and Regards,

**Dr. Varun G Menon**

Associate Professor-Computer Science Engineering

Exe. Officer-Corporate Relations & International Collaborations

SCMS School of Engineering and Technology

Kerala, India-683582

Office: +91-484-2450330 Mob: +91-8714504684

Web: <http://www.scmsgroup.org/sset/computer-science-engineering/dr-varun-g-menon>



**SCMS**

School of Engineering & Technology

On Mon, Jun 25, 2018 at 3:55 PM, International Affairs, DIU

<[int@daffodilvarsity.edu.bd](mailto:int@daffodilvarsity.edu.bd)> wrote:

Dear Dr. Varun

Thank you so much for your email and letting us know the update.

- With best regards

**Syed Raihan-UI-Islam**

**Senior Administrative Officer, International Affairs**  
**Daffodil International University**

102/1, Shukrabad, Dhanmondi, Dhaka-1207, Bangladesh.

Tel: **+88 02 9138234 (Ext: 237)** | Mob: **+88-01811458865**

WhatsApp/Viber/Wechat: **+88-01920012744**

On Mon, Jun 25, 2018 at 4:14 PM, Dr. Varun G Menon

<[varunmenon@scmsgroup.org](mailto:varunmenon@scmsgroup.org)> wrote:

Dear Mr. Syed Raihan-UI-Islam,

Thank you for the collaboration with SCMS. I have presented the MoU with the Vice Chairman for approval. Once the approval is obtained, I will send back the approved soft copy of the MoU.

I have discussed about the Short Term Internships for students from DIU at the Centre for Robotics, SCMS with the Director, Robotics Lab. He has promised to send me The Best Plan for DIU students within two days. I will send you the same at the earliest.

Thanks and Regards,

**Dr. Varun G Menon**

Associate Professor-Computer Science Engineering

Exe. Officer-Corporate Relations & International Collaborations

SCMS School of Engineering and Technology

Kerala, India-683582

Office: +91-484-2450330 Mob: +91-8714504684

Web: <http://www.scmsgroup.org/sset/computer-science-engineering/dr-varun-g-menon>



**SCMS**

School of Engineering & Technology

On Sun, Jun 24, 2018 at 12:56 AM, Dr. Varun G Menon

<[varunmenon@scmsgroup.org](mailto:varunmenon@scmsgroup.org)> wrote:

Dear Mr. Syed Raihan-UI-Islam,

Thank you for the email. Will inform the Professor's in charge of the Cyber Security and Robotics research centers about the program plan. Will sent you the documents soon.

Have a Great Day.

Thanks and Regards,

**Dr. Varun G Menon**

Associate Professor-Computer Science Engineering

Exe. Officer-Corporate Relations & International Collaborations

SCMS School of Engineering and Technology

Kerala, India-683582

Office: +91-484-2450330 Mob: +91-8714504684

Web: <http://www.scmsgroup.org/sset/computer-science-engineering/dr-varun-g-menon>



**SCMS**

School of Engineering & Technology

On Sun, Jun 24, 2018 at 12:17 AM, International Affairs, DIU

<[int@daffodilvarsity.edu.bd](mailto:int@daffodilvarsity.edu.bd)> wrote:

Dear Dr, Varun

Thank you very much for your quick response.

It would be great if you can share any proposal or program plan with all details, course plan, costing etc of the Summer internships based on Cyber Security and Robotics so that we could check and show t our students for interest.

Hope to receive the agreement and the program proposals soon. Have a great day !

- With best regards

**Syed Raihan-UI-Islam**

**Senior Administrative Officer, International Affairs**

**Daffodil International University**

102/1, Shukrabad, Dhanmondi, Dhaka-1207, Bangladesh.

Tel: **+88 02 9138234 (Ext: 237)** | Mob: **+88-01811458865**  
WhatsApp/Viber/Wechat: **+88-01920012744**

On Sun, Jun 24, 2018 at 12:35 AM, Dr. Varun G Menon  
<[varunmenon@scmsgroup.org](mailto:varunmenon@scmsgroup.org)> wrote:

Dear Mr. Syed Raihan-UI-Islam,

Thank you for the information about Daffodil International University. Will complete the agreement copy and send you at the earliest.

We have 5 active research groups in our Engineering College that include Centre for Robotics, Centre for Cyber Security, Hydrodynamics and Computational Fluid Dynamics, Antennas and Radiation, Centre for Sustainable Water Technology and Management. Students from your University can do summer internships and short term projects with these project groups.

Besides we also have one of the leading Management Institute in India and also Biotechnology Research Centre.

Thank you for the collaboration. Will send you the document soon.

Regards,

**Dr. Varun G Menon**

Associate Professor-Computer Science Engineering  
Exe. Officer-Corporate Relations & International  
Collaborations

SCMS School of Engineering and Technology  
Kerala, India-683582

Office: +91-484-2450330 Mob: +91-8714504684

Web: <http://www.scmsgroup.org/sset/computer-science-engineering/dr-varun-g-menon>



**SCMS**

School of Engineering & Technology

On Sat, Jun 23, 2018 at 6:42 PM, International Affairs, DIU  
<[int@daffodilvarsity.edu.bd](mailto:int@daffodilvarsity.edu.bd)> wrote:

**Dear Dr. Varun G Menon,**

**Greetings from DIU!**

**Thanks for your email and showing interest in the academic partnership. Yes, we can collaborate in the areas of student exchange programs, faculty exchange programs, summer school research collaborations, joint seminars and conferences.**

**I have attached here the sample agreement copy of DIU, Could you please check and fill it with your information. Besides, I have attached here the fact sheet of DIU where you can check our common details and department.**

**Your CSE, ECE and EEE Department can be a good prospect between both universities. Let us know your observation**

**Looking forward to hearing from you soon.**

*- With best regards*

**Syed Raihan-UI-Islam**

**Senior Administrative Officer, International Affairs**

**Daffodil International University**

102/1, Shukrabad, Dhanmondi, Dhaka-1207, Bangladesh.

Tel: **+88 02 9138234 (Ext: 237)** | Mob: **+88-01811458865**  
WhatsApp/Viber/Wechat: **+88-01920012744**

Respected Mr. Salahuddin Morsalin

Thank you for your time and consideration. Let me introduce as Dr. Varun G Menon, in charge of International Collaborations at SCMS Group of Educational Institutions, India.

We are interested in having academic collaboration with Daffodil International University. Collaboration could be in the areas of student exchange programs, faculty exchange programs, research collaborations, joint seminars and conferences.

We have a dedicate team of faculty and students working in areas like Robotics, Brain Signal Analysis, Computational fluid dynamics. Water Quality Monitoring and Assessment, Limnology, Water Audit, Environmental Remote Sensing , Android Malware Analysis. Research collaborations in these areas is another possibility.

We have academic collaborations with leading international universities like Vrije University-Brussels, Furtwangen University-Germany, University of Applied Sciences Ravensburg Weingarten- Germany, Shimane University-Japan and more.

**Please let me know if we could discuss and take forward this initiative.**

For your information we are the No 1 ranked private educational institutions in the state. You can find more information about our institutions in [www.scmsgroup.org](http://www.scmsgroup.org) and about out Engineering Institute in [www.scmsgroup.org/sset/](http://www.scmsgroup.org/sset/)

Have a Great Day.

Thanks and Regards,

**Dr. Varun G Menon**

Associate Professor-Computer Science Engineering  
Exe. Officer-Corporate Relations & International  
Collaborations  
SCMS School of Engineering and Technology  
Kerala, India-683582  
Office: +91-484-2450330 Mob: +91-8714504684  
Web: <http://www.scmsgroup.org/sset/computer-science-engineering/dr-varun-g-menon>



**SCMS**

School of Engineering & Technology

--  
Thanks and Regards,

**Dr. Varun G Menon**

Associate Professor-Computer Science Engineering  
Exe. Officer-Corporate Relations & International Collaborations  
SCMS School of Engineering and Technology  
Kerala, India-683582  
Office: +91-484-2450330 Mob: +91-8714504684  
Web: <http://www.scmsgroup.org/sset/computer-science-engineering/dr-varun-g-menon>



--  
Thanks and Regards,

**Dr. Varun G Menon**

Associate Professor-Computer Science Engineering  
Exe. Officer-Corporate Relations & International Collaborations  
SCMS School of Engineering and Technology  
Kerala, India-683582  
Office: +91-484-2450330 Mob: +91-8714504684  
Web: <http://www.scmsgroup.org/sset/computer-science-engineering/dr-varun-g-menon>



--  
Thanks and Regards,

**Dr. Varun G Menon**

Associate Professor-Computer Science Engineering  
Exe. Officer-Corporate Relations & International Collaborations  
SCMS School of Engineering and Technology  
Kerala, India-683582  
Office: +91-484-2450330 Mob: +91-8714504684  
Web: <http://www.scmsgroup.org/sset/computer-science-engineering/dr-varun-g-menon>



8 attachments



01.jpg  
554K

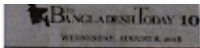

02.jpg  
1013K

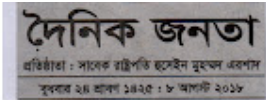

03.jpg  
365K

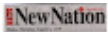

04.jpg  
1416K



05.jpg  
535K

06.jpg  
556K



07.jpg  
603K



08.jpg  
554K

**Dr. Varun G Menon** <varunmenon@scmsgroup.org> Mon, Aug 20, 2018 at 12:14 PM  
 To: "International Affairs, DIU" <int@daffodilvarsity.edu.bd>  
 Cc: Emran Hossain <emran@daffodilvarsity.edu.bd>, "International, DIU" <international@daffodilvarsity.edu.bd>, "Office of the International Affairs, DIU" <mobility@daffodilvarsity.edu.bd>, Scholarship News <scholarship@daffodilvarsity.edu.bd>, Pramod <pramod@scmsgroup.org>, Kazi Mesbah Ur Rahman <oia@daffodilvarsity.edu.bd>, Indu Nair <indunair@scmsgroup.org>, "Dr. Praveensal C.J." <praveensal@scmsgroup.org>

Dear Mr. Syed Raihan-UI-Islam,  
 Hope you are doing great. Thank you for the information on media coverage and photos of the MoU signing between SCMS and Daffodil International University.  
 We are having holidays till August 29th. Will send you the program details soon.  
 I will discuss the possibility of Visiting faculty from SCMS at DIU and will let you know.

Thanks and Regards,

**Dr. Varun G Menon**  
 Associate Professor & Head of International Relations  
 SCMS Group of Educational Institutions  
 Cochin, Kerala, India-683106  
 Office: +91-484-2450330 Mob: +91-8714504684  
 Web: <http://www.scmsgroup.org>



On Sun, Aug 19, 2018 at 3:13 PM, International Affairs, DIU <int@daffodilvarsity.edu.bd> wrote:

Dear Dr. Varun,

Greetings!

Hope you are doing well. We thank you and honorable Vice Chairman for visiting us and sign the agreement. Let us work and plan together to activate the partnership soon.



So far I remember you have some program plans that you were working to send me. Once it's ready please do send us, At the same time, we invite your faculty member to come and teach for short term period as exchange faculty. let us know the possibility

Here I attached some news coverage that published in different national daily newspapers (Both Bangla and English) about the agreement signing between DIU and SCMS group.

Have a great day!

- With best regards

**Syed Raihan-UI-Islam**

**Senior Administrative Officer, International Affairs**

**Daffodil International University**

102/1, Shukrabad, Dhanmondi, Dhaka-1207, Bangladesh.

Tel: **+88 02 9138234 (Ext: 237)** | Mob: **+88-01811458865**

WhatsApp/Viber/Wechat: **+88-01920012744**

On Fri, Jul 13, 2018 at 1:51 PM, International Affairs, DIU <[int@daffodilvarsity.edu.bd](mailto:int@daffodilvarsity.edu.bd)> wrote:

Dear Dr. Varun

Yes we will arrange pick and drop for you and your Vice Chairman

- With best regards

**Syed Raihan-UI-Islam**

**Senior Administrative Officer, International Affairs**

**Daffodil International University**

102/1, Shukrabad, Dhanmondi, Dhaka-1207, Bangladesh.

Tel: **+88 02 9138234 (Ext: 237)** | Mob: **+88-01811458865**

WhatsApp/Viber/Wechat: **+88-01920012744**

On Thu, Jul 12, 2018 at 9:58 PM, Dr. Varun G Menon <[varunmenon@scmsgroup.org](mailto:varunmenon@scmsgroup.org)> wrote:

Dear Mr. Syed Raihan-UI-Islam,

Thank you for the collaboration with SCMS.

Kindly see below the details of hotel reserved by us

**Hotel Name: Best Western B/W La Vinci Hotel**

**Address: 54, Kawran Bazar, Dhaka, Bangladesh 1215**

Please let me know if you would be arranging a pick up from the hotel to the DIU campus. We could start at 1.30 pm from the hotel to the DIU campus for the visit and signing of the MoU.

Thanks and Regards,

**Dr. Varun G Menon**

Associate Professor & Head of International Relations

SCMS Group of Educational Institutions

Cochin, Kerala, India-683106

Office: +91-484-2450330 Mob: +91-8714504684

Web: <http://www.scmsgroup.org>



**SCMS**

GROUP OF EDUCATIONAL INSTITUTIONS

On Mon, Jul 9, 2018 at 10:58 AM, International Affairs, DIU <[int@daffodilvarsity.edu.bd](mailto:int@daffodilvarsity.edu.bd)> wrote:

Dear Dr. Varun,

Here is the address that i already gave you in whatsapp:

**Daffodil International University**

102/1, Shukrabad, Dhanmondi, Dhaka-1207

Bangladesh

some hotels nearby our campus:

<http://www.ambalainn.com>

<https://www.panpacific.com/en/hotels-and-resorts/pp-dhaka.html>

- With best regards

**Syed Raihan-UI-Islam**

**Senior Administrative Officer, International Affairs**

**Daffodil International University**

102/1, Shukrabad, Dhanmondi, Dhaka-1207, Bangladesh.

Tel: **+88 02 9138234 (Ext: 237)** | Mob: **+88-01811458865**

WhatsApp/Viber/Wechat: **+88-01920012744**

On Thu, Jul 5, 2018 at 5:25 PM, Dr. Varun G Menon <[varunmenon@scmsgroup.org](mailto:varunmenon@scmsgroup.org)> wrote:

Dear Mr. Syed Raihan-UI-Islam,

Thank you for the collaboration with SCMS. Please let us know the campus address of DIU where the visit and MoU signing ceremony is planned so that we could arrange the stay in a hotel near the campus. We could see multiple campuses of DIU in the website. It would also be great if you could give the names of few good hotels near your campus.

Thanks and Regards,

**Dr. Varun G Menon**

Associate Professor, Computer Science Engineering

Exe. Officer, Corporate Relations & International Collaborations

SCMS School of Engineering and Technology

Kerala, India-683582

Office: +91-484-2450330 Mob: +91-8714504684

Web: <http://www.scmsgroup.org/sset/computer-science-engineering/dr-varun-g-menon>



**SCMS**

School of Engineering & Technology

On Tue, Jul 3, 2018 at 5:04 PM, International Affairs, DIU <[int@daffodilvarsity.edu.bd](mailto:int@daffodilvarsity.edu.bd)> wrote:

Dear Dr. Varun

Yes Confirm so far. Thank You

- With best regards

**Syed Raihan-UI-Islam**

**Senior Administrative Officer, International Affairs**

**Daffodil International University**

102/1, Shukrabad, Dhanmondi, Dhaka-1207, Bangladesh.

Tel: **+88 02 9138234 (Ext: 237)** | Mob: **+88-01811458865**

WhatsApp/Viber/Wechat: **+88-01920012744**

On Tue, Jul 3, 2018 at 3:57 AM, Dr. Varun G Menon <[varunmenon@scmsgroup.org](mailto:varunmenon@scmsgroup.org)> wrote:

Dear Mr. Syed Raihan-UI-Islam

Thank you for the valuable time. Please confirm the schedule as discussed and agreed earlier. No need to change the schedule. Our flight is scheduled only in the night.

- MoU Signing Ceremony and discussion session on **25th July 2018 from 3PM to 5PM**
- Visit to DIU Permanent Campus and Lunch on the on that day **9AM to 2PM**

Thanks and Regards,

**Dr. Varun G Menon**

Associate Professor, Computer Science Engineering

Exe. Officer, Corporate Relations & International Collaborations

SCMS School of Engineering and Technology

Kerala, India-683582

Office: +91-484-2450330 Mob: +91-8714504684

Web: <http://www.scmsgroup.org/sset/computer-science-engineering/dr-varun-g-menon>



On Sun, Jul 1, 2018 at 12:09 PM, Dr. Varun G Menon <[varunmenon@scmsgroup.org](mailto:varunmenon@scmsgroup.org)> wrote:

Dear Mr. Syed Raihan-UI-Islam,

Please let me know if you can arrange the MoU signing ceremony and discussion on collaboration at DIU on **25th July morning** as we have flight back to India in the evening.

Thank you,

**Dr. Varun G Menon**

Associate Professor-Computer Science Engineering  
Exe. Officer-Corporate Relations & International Collaborations  
SCMS School of Engineering and Technology  
Kerala, India-683582

Office: +91-484-2450330 Mob: +91-8714504684

Web: <http://www.scmsgroup.org/sset/computer-science-engineering/dr-varun-g-menon>



On Thu, Jun 28, 2018 at 1:32 PM, Dr. Varun G Menon <[varunmenon@scmsgroup.org](mailto:varunmenon@scmsgroup.org)> wrote:

Dear Mr. Syed Raihan-UI-Islam,

Thank you for the invitation letter. Looking forward to the meeting. Will update our schedule once we confirm the flight tickets.

Thanks and Regards,

**Dr. Varun G Menon**

Associate Professor-Computer Science Engineering  
Exe. Officer-Corporate Relations & International Collaborations  
SCMS School of Engineering and Technology  
Kerala, India-683582

Office: +91-484-2450330 Mob: +91-8714504684

Web: <http://www.scmsgroup.org/sset/computer-science-engineering/dr-varun-g-menon>



On Thu, Jun 28, 2018 at 1:09 PM, International Affairs, DIU <[int@daffodilvarsity.edu.bd](mailto:int@daffodilvarsity.edu.bd)> wrote:

Dear Dr. Varun

Please find the attached letter of Invitation for both of you to visit us for the purpose of the meeting and signing the agreement.

- *With best regards*

**Syed Raihan-UI-Islam**

**Senior Administrative Officer, International Affairs**

**Daffodil International University**

102/1, Shukrabad, Dhanmondi, Dhaka-1207, Bangladesh.

Tel: **+88 02 9138234 (Ext: 237)** | Mob: **+88-01811458865**  
WhatsApp/Viber/Wechat: **+88-01920012744**

On Thu, Jun 28, 2018 at 8:20 AM, Dr. Varun G Menon <[varunmenon@scmsgroup.org](mailto:varunmenon@scmsgroup.org)> wrote:

Dear Mr. Syed Raihan-UI-Islam,

Please see below the details of members visiting DIU on 25th July 2018. Please send us the **invitation letter for the Visa** based on this information.

**Names**

Prof. **PRAMOD PRATHAPACHANDRAN THEVANNOOR**, Vice Chairman, SCMS Group of Educational Institutions.

Dr. **VARUN GIRIJAN MENON**, Associate Professor and International Relations in-charge, SCMS Group of Educational Institutions.

**Address**

SCMS Group of Educational Institutions  
SCMS Campus, Prathap Nagar  
Muttom, Aluva  
Cochin – 683 106, Kerala, INDIA

Let me know any further information required.

Thanks and Regards,

**Dr. Varun G Menon**

Associate Professor-Computer Science Engineering  
Exe. Officer-Corporate Relations & International Collaborations  
SCMS School of Engineering and Technology  
Kerala, India-683582  
Office: +91-484-2450330 Mob: +91-8714504684  
Web: <http://www.scmsgroup.org/sset/computer-science-engineering/dr-varun-g-menon>



**SCMS**  
School of Engineering & Technology

On Wed, Jun 27, 2018 at 11:48 AM, International Affairs, DIU <[int@daffodilvarsity.edu.bd](mailto:int@daffodilvarsity.edu.bd)> wrote:

Dear Dr. Varun

Thanks. I am looking forward.

- *With best regards*

**Syed Raihan-UI-Islam**

**Senior Administrative Officer, International Affairs**  
**Daffodil International University**

102/1, Shukrabad, Dhanmondi, Dhaka-1207, Bangladesh.

Tel: **+88 02 9138234 (Ext: 237)** | Mob: **+88-01811458865**

WhatsApp/Viber/Wechat: **+88-01920012744**

On Wed, Jun 27, 2018 at 12:15 PM, Dr. Varun G Menon <[varunmenon@scmsgroup.org](mailto:varunmenon@scmsgroup.org)> wrote:

Dear Mr. Syed Raihan-UI-Islam,

Thank you for the information. We will have the visit on 25th July. We will send the details of the members visiting the DIU campus at the earliest.

Regards

Varun

On Wednesday, June 27, 2018, International Affairs, DIU <[int@daffodilvarsity.edu.bd](mailto:int@daffodilvarsity.edu.bd)> wrote:

Dear Dr. Varun,

I have discussed with the Office of the Vice Chancellor

We can arrange the MoU Signing Ceremony and discussion session on **25 July 2018** from **3PM to 5PM**

We can also arrange to visit our Permanent Campus and Lunch on the on that day 9AM to 2PM too.

Let us know if the time and date is convenient for your visit

Looking forward to hearing from you.

- *With best regards*

**Syed Raihan-UI-Islam**

**Senior Administrative Officer, International Affairs**

**Daffodil International University**

102/1, Shukrabad, Dhanmondi, Dhaka-1207, Bangladesh.

Tel: **+88 02 9138234 (Ext: 237)** | Mob: **+88-01811458865**

WhatsApp/Viber/Wechat: **+88-01920012744**

On Wed, Jun 27, 2018 at 11:18 AM, Dr. Varun G Menon <[varunmenon@scmsgroup.org](mailto:varunmenon@scmsgroup.org)> wrote:

Dear Mr. Syed Raihan-UI-Islam,

Can we have the visit between July 24 and 27. Our Vice Chairman is traveling on other dates in July.

Please let me know.

Varun

On Wednesday, June 27, 2018, International Affairs, DIU <[int@daffodilvarsity.edu.bd](mailto:int@daffodilvarsity.edu.bd)> wrote:

Dear Dr. Varun

Can we shift it to the next week I mean in between 15 to 20 July?

- *With best regards*

**Syed Raihan-UI-Islam**

**Senior Administrative Officer, International Affairs**

**Daffodil International University**

102/1, Shukrabad, Dhanmondi, Dhaka-1207, Bangladesh.

Tel: **+88 02 9138234 (Ext: 237)** | Mob: **+88-01811458865**

WhatsApp/Viber/Wechat: **+88-01920012744**

On Wed, Jun 27, 2018 at 10:55 AM, Dr. Varun G Menon <[varunmenon@scmsgroup.org](mailto:varunmenon@scmsgroup.org)> wrote:

Dear Mr. Syed Raihan-UI-Islam,

Thank you for the message. We would like to visit DIU between 10th and 14th July.

Please let us know if the date is convenient at your end. Also it would be great if you could send us an Invitation letter which could be produced for the Visa.

Let me know any further details required.

Varun

On Tuesday, June 26, 2018, International Affairs, DIU <[int@daffodilvarsity.edu.bd](mailto:int@daffodilvarsity.edu.bd)> wrote:

Dear Dr. Varun

That is a good idea. Let us know your possible dates to visit us and sign the agreement between both of the universities.

- *With best regards*

**Syed Raihan-UI-Islam**

**Senior Administrative Officer, International Affairs**

**Daffodil International University**

102/1, Shukrabad, Dhanmondi, Dhaka-1207, Bangladesh.  
Tel: +88 02 9138234 (Ext: 237) | Mob: +88-01811458865  
WhatsApp/Viber/Wechat: +88-01920012744

On Tue, Jun 26, 2018 at 10:38 PM, Dr. Varun G Menon  
<[varunmenon@scmsgroup.org](mailto:varunmenon@scmsgroup.org)> wrote:

Dear Mr. Syed Raihan-UI-Islam,

Thank you for the collaboration with SCMS. We would like to visit the DIU campus on a favorable date and would like to sign the MoU with the Vice Chancellor at DIU.

We would be more than happy to host the DIU team with Vice Chancellor in our campus in future. Please let me know your thoughts.

Thanks and Regards,

**Dr. Varun G Menon**

Associate Professor-Computer Science Engineering  
Exe. Officer-Corporate Relations & International Collaborations  
SCMS School of Engineering and Technology  
Kerala, India-683582  
Office: +91-484-2450330 Mob: +91-8714504684  
Web: <http://www.scmsgroup.org/sset/computer-science-engineering/dr-varun-g-menon>



**SCMS**

School of Engineering & Technology

On Tue, Jun 26, 2018 at 6:54 PM, International Affairs, DIU  
<[int@daffodilvarsity.edu.bd](mailto:int@daffodilvarsity.edu.bd)> wrote:

Dear Dr. Varun

Thank you very much for the agreement final copy. It's fine

May I request you to sign the agreement and send the copies to me either scan copy in my email or 2 original copies in my address given in my email signature

- With best regards

**Syed Raihan-UI-Islam**

**Senior Administrative Officer, International Affairs**  
**Daffodil International University**  
102/1, Shukrabad, Dhanmondi, Dhaka-1207, Bangladesh.  
Tel: +88 02 9138234 (Ext: 237) | Mob: +88-01811458865  
WhatsApp/Viber/Wechat: +88-01920012744

On Tue, Jun 26, 2018 at 7:01 PM, Dr. Varun G Menon  
<[varunmenon@scmsgroup.org](mailto:varunmenon@scmsgroup.org)> wrote:

Dear Mr. Syed Raihan-UI-Islam,

Thank you for the collaboration with SCMS. Please see the attached MoU draft approved by our Vice Chairman. Please let me know the remaining procedures including the signing of the MoU.

Thanks and Regards,

**Dr. Varun G Menon**

Associate Professor-Computer Science Engineering  
Exe. Officer-Corporate Relations & International Collaborations  
SCMS School of Engineering and Technology  
Kerala, India-683582  
Office: +91-484-2450330 Mob: +91-8714504684  
Web: <http://www.scmsgroup.org/sset/computer-science-engineering/dr-varun-g-menon>



On Mon, Jun 25, 2018 at 3:55 PM, International Affairs, DIU  
<[int@daffodilvarsity.edu.bd](mailto:int@daffodilvarsity.edu.bd)> wrote:

Dear Dr. Varun

Thank you so much for your email and letting us know the update.

- With best regards

**Syed Raihan-UI-Islam**

**Senior Administrative Officer, International Affairs**  
**Daffodil International University**

102/1, Shukrabad, Dhanmondi, Dhaka-1207, Bangladesh.

Tel: +88 02 9138234 (Ext: 237) | Mob: +88-01811458865

WhatsApp/Viber/Wechat: +88-01920012744

On Mon, Jun 25, 2018 at 4:14 PM, Dr. Varun G Menon

<[varunmenon@scmsgroup.org](mailto:varunmenon@scmsgroup.org)> wrote:

Dear Mr. Syed Raihan-UI-Islam,

Thank you for the collaboration with SCMS. I have presented the MoU with the Vice Chairman for approval. Once the approval is obtained, I will send back the approved soft copy of the MoU.

I have discussed about the Short Term Internships for students from DIU at the Centre for Robotics, SCMS with the Director, Robotics Lab. He has promised to send me The Best Plan for DIU students within two days. I will send you the same at the earliest.

Thanks and Regards,

**Dr. Varun G Menon**

Associate Professor-Computer Science Engineering

Exe. Officer-Corporate Relations & International Collaborations

SCMS School of Engineering and Technology

Kerala, India-683582

Office: +91-484-2450330 Mob: +91-8714504684

Web: <http://www.scmsgroup.org/sset/computer-science-engineering/dr-varun-g-menon>



**SCMS**  
School of Engineering & Technology

On Sun, Jun 24, 2018 at 12:56 AM, Dr. Varun G Menon

<[varunmenon@scmsgroup.org](mailto:varunmenon@scmsgroup.org)> wrote:

Dear Mr. Syed Raihan-UI-Islam,

Thank you for the email. Will inform the Professor's in charge of the Cyber Security and Robotics research centers about the program plan.

Will sent you the documents soon.

Have a Great Day.

Thanks and Regards,

**Dr. Varun G Menon**

Associate Professor-Computer Science Engineering

Exe. Officer-Corporate Relations & International Collaborations

SCMS School of Engineering and Technology  
Kerala, India-683582  
Office: +91-484-2450330 Mob: +91-8714504684  
Web: <http://www.scmsgroup.org/ssset/computer-science-engineering/dr-varun-g-menon>



**SCMS**  
School of Engineering & Technology

On Sun, Jun 24, 2018 at 12:17 AM, International Affairs, DIU  
<[int@daffodilvarsity.edu.bd](mailto:int@daffodilvarsity.edu.bd)> wrote:

Dear Dr, Varun

Thank you very much for your quick response.

It would be great if you can share any proposal or program plan with all details, course plan, costing etc of the Summer internships based on Cyber Security and Robotics so that we could check and show to our students for interest.

Hope to receive the agreement and the program proposals soon.  
Have a great day !

- With best regards

**Syed Raihan-UI-Islam**

**Senior Administrative Officer, International Affairs**

**Daffodil International University**

102/1, Shukrabad, Dhanmondi, Dhaka-1207, Bangladesh.

Tel: **+88 02 9138234 (Ext: 237)** | Mob: **+88-01811458865**

WhatsApp/Viber/Wechat: **+88-01920012744**

On Sun, Jun 24, 2018 at 12:35 AM, Dr. Varun G Menon

<[varunmenon@scmsgroup.org](mailto:varunmenon@scmsgroup.org)> wrote:

Dear Mr. Syed Raihan-UI-Islam,

Thank you for the information about Daffodil International University. Will complete the agreement copy and send you at the earliest.

We have 5 active research groups in our Engineering College that include Centre for Robotics, Centre for Cyber Security, Hydrodynamics and Computational Fluid Dynamics, Antennas and Radiation, Centre for Sustainable Water Technology and Management. Students from your University can do summer internships and short term projects with these project groups.

Besides we also have one of the leading Management Institute in India and also Biotechnology Research Centre.

Thank you for the collaboration. Will send you the document soon.

Regards,

**Dr. Varun G Menon**

Associate Professor-Computer Science Engineering

Exe. Officer-Corporate Relations & International

Collaborations

SCMS School of Engineering and Technology

Kerala, India-683582

Office: +91-484-2450330 Mob: +91-8714504684

Web: <http://www.scmsgroup.org/ssset/computer-science-engineering/dr-varun-g-menon>





**SCMS**  
School of Engineering & Technology

On Sat, Jun 23, 2018 at 6:42 PM, International Affairs, DIU  
<[int@daffodilvarsity.edu.bd](mailto:int@daffodilvarsity.edu.bd)> wrote:

Dear Dr. Varun G Menon,

**Greetings from DIU!**

**Thanks for your email and showing interest in the academic partnership. Yes, we can collaborate in the areas of student exchange programs, faculty exchange programs, summer school research collaborations, joint seminars and conferences.**

**I have attached here the sample agreement copy of DIU, Could you please check and fill it with your information. Besides, I have attached here the fact sheet of DIU where you can check our common details and department.**

**Your CSE, ECE and EEE Department can be a good prospect between both universities. Let us know your observation**

**Looking forward to hearing from you soon.**

*- With best regards*

**Syed Raihan-UI-Islam**

**Senior Administrative Officer, International Affairs  
Daffodil International University**

102/1, Shukrabad, Dhanmondi, Dhaka-1207, Bangladesh.

Tel: **+88 02 9138234 (Ext: 237)** | Mob: **+88-01811458865**

WhatsApp/Viber/Wechat: **+88-01920012744**

Respected Mr. Salahuddin Morsalin

Thank you for your time and consideration. Let me introduce as Dr. Varun G Menon, in charge of International Collaborations at SCMS Group of Educational Institutions, India.

We are interested in having academic collaboration with Daffodil International University. Collaboration could be in the areas of student exchange programs, faculty exchange programs, research collaborations, joint seminars and conferences.

We have a dedicate team of faculty and students working in areas like Robotics, Brain Signal Analysis, Computational fluid dynamics. Water Quality Monitoring and Assessment, Limnology, Water Audit, Environmental Remote Sensing , Android Malware Analysis. Research collaborations in these areas is another possibility.

We have academic collaborations with leading international universities like Vrije University-Brussels, Furtwangen University-Germany, University of Applied Sciences Ravensburg Weingarten- Germany, Shimane University- Japan and more.

**Please let me know if we could discuss and take forward this initiative.**

For your information we are the No 1 ranked private educational institutions in the state. You can find more information about our institutions in [www.scmsgroup.org](http://www.scmsgroup.org) and about our Engineering Institute in [www.scmsgroup.org/sset/](http://www.scmsgroup.org/sset/) Have a Great Day.

Thanks and Regards,

**Dr. Varun G Menon**

Associate Professor-Computer Science Engineering  
Exe. Officer-Corporate Relations & International Collaborations  
SCMS School of Engineering and Technology  
Kerala, India-683582  
Office: +91-484-2450330 Mob: +91-8714504684  
Web: <http://www.scmsgroup.org/sset/computer-science-engineering/dr-varun-g-menon>



**SCMS**  
School of Engineering & Technology

--  
Thanks and Regards,

**Dr. Varun G Menon**

Associate Professor-Computer Science Engineering  
Exe. Officer-Corporate Relations & International Collaborations  
SCMS School of Engineering and Technology  
Kerala, India-683582  
Office: +91-484-2450330 Mob: +91-8714504684  
Web: <http://www.scmsgroup.org/sset/computer-science-engineering/dr-varun-g-menon>



**SCMS**  
School of Engineering & Technology

--  
Thanks and Regards,

**Dr. Varun G Menon**

Associate Professor-Computer Science Engineering  
Exe. Officer-Corporate Relations & International Collaborations  
SCMS School of Engineering and Technology

Kerala, India-683582

Office: +91-484-2450330 Mob: +91-8714504684

Web: <http://www.scmsgroup.org/sset/computer-science-engineering/dr-varun-g-menon>



**SCMS**  
School of Engineering & Technology

--  
Thanks and Regards,

**Dr. Varun G Menon**

Associate Professor-Computer Science Engineering

Exe. Officer-Corporate Relations & International Collaborations

SCMS School of Engineering and Technology

Kerala, India-683582

Office: +91-484-2450330 Mob: +91-8714504684

Web: <http://www.scmsgroup.org/sset/computer-science-engineering/dr-varun-g-menon>



**SCMS**  
School of Engineering & Technology

---

**International Affairs, DIU** <int@daffodilvarsity.edu.bd>

Mon, Aug 20, 2018 at 12:27 PM

To: "Dr. Varun G Menon" <varunmenon@scmsgroup.org>

Cc: Emran Hossain <emran@daffodilvarsity.edu.bd>, "International, DIU" <international@daffodilvarsity.edu.bd>, "Office of the International Affairs, DIU" <mobility@daffodilvarsity.edu.bd>, Scholarship News <scholarship@daffodilvarsity.edu.bd>, Pramod <pramod@scmsgroup.org>, Kazi Mesbah Ur Rahman <oia@daffodilvarsity.edu.bd>, Indu Nair <indunair@scmsgroup.org>, "Dr. Praveensal C.J." <praveensal@scmsgroup.org>

Dear Dr. Varun

Thanks for letting us know. Have great and pleasant times throughout the vacation.

- With best regards

**Syed Raihan-UI-Islam**

**Senior Administrative Officer, International Affairs**

**Daffodil International University**

102/1, Shukrabad, Dhanmondi, Dhaka-1207, Bangladesh.

Tel: **+88 02 9138234 (Ext: 237)** | Mob: **+88-01811458865**

WhatsApp/Viber/Wechat: **+88-01920012744**

On Mon, Aug 20, 2018 at 12:44 PM, Dr. Varun G Menon <varunmenon@scmsgroup.org> wrote:

Dear Mr. Syed Raihan-UI-Islam,

Hope you are doing great. Thank you for the information on media coverage and photos of the MoU signing between SCMS and Daffodil International University.  
We are having holidays till August 29th. Will send you the program details soon.  
I will discuss the possibility of Visiting faculty from SCMS at DIU and will let you know.

Thanks and Regards,

**Dr. Varun G Menon**

Associate Professor & Head of International Relations  
SCMS Group of Educational Institutions  
Cochin, Kerala, India-683106  
Office: +91-484-2450330 Mob: +91-8714504684  
Web: <http://www.scmsgroup.org>



On Sun, Aug 19, 2018 at 3:13 PM, International Affairs, DIU <[int@daffodilvarsity.edu.bd](mailto:int@daffodilvarsity.edu.bd)> wrote:

Dear Dr. Varun,

Greetings!

Hope you are doing well. We thank you and honorable Vice Chairman for visiting us and sign the agreement. Let us work and plan together to activate the partnership soon.

So far I remember you have some program plans that you were working to send me. Once it's ready please do send us, At the same time, we invite your faculty member to come and teach for short term period as exchange faculty. let us know the possibility

Here I attached some news coverage that published in different national daily newspapers (Both Bangla and English) about the agreement signing between DIU and SCMS group.

Have a great day!

- With best regards

**Syed Raihan-UI-Islam**

**Senior Administrative Officer, International Affairs**  
**Daffodil International University**  
102/1, Shukrabad, Dhanmondi, Dhaka-1207, Bangladesh.  
Tel: **+88 02 9138234 (Ext: 237)** | Mob: **+88-01811458865**  
WhatsApp/Viber/Wechat: **+88-01920012744**

On Fri, Jul 13, 2018 at 1:51 PM, International Affairs, DIU <[int@daffodilvarsity.edu.bd](mailto:int@daffodilvarsity.edu.bd)> wrote:

Dear Dr. Varun

Yes we will arrange pick and drop for you and your Vice Chairman

- With best regards

**Syed Raihan-UI-Islam**

**Senior Administrative Officer, International Affairs**  
**Daffodil International University**  
102/1, Shukrabad, Dhanmondi, Dhaka-1207, Bangladesh.  
Tel: **+88 02 9138234 (Ext: 237)** | Mob: **+88-01811458865**  
WhatsApp/Viber/Wechat: **+88-01920012744**

On Thu, Jul 12, 2018 at 9:58 PM, Dr. Varun G Menon <[varunmenon@scmsgroup.org](mailto:varunmenon@scmsgroup.org)> wrote:

Dear Mr. Syed Raihan-UI-Islam,

Thank you for the collaboration with SCMS.

Kindly see below the details of hotel reserved by us

**Hotel Name: Best Western B/W La Vinci Hotel**  
**Address: 54, Kawran Bazar, Dhaka, Bangladesh 1215**

Please let me know if you would be arranging a pick up from the hotel to the DIU campus. We could start at 1.30 pm from the hotel to the DIU campus for the visit and signing of the MoU.

Thanks and Regards,

**Dr. Varun G Menon**

Associate Professor & Head of International Relations  
SCMS Group of Educational Institutions  
Cochin, Kerala, India-683106  
Office: +91-484-2450330 Mob: +91-8714504684  
Web: <http://www.scmsgroup.org>



**SCMS**  
GROUP OF EDUCATIONAL INSTITUTIONS

On Mon, Jul 9, 2018 at 10:58 AM, International Affairs, DIU <[int@daffodilvarsity.edu.bd](mailto:int@daffodilvarsity.edu.bd)> wrote:

Dear Dr. Varun,

Here is the address that i already gave you in whatsapp:

[Daffodil International University](#)  
102/1, Shukrabad, Dhanmondi, Dhaka-1207  
Bangladesh

some hotels nearby our campus:

<http://www.ambalainn.com>

<https://www.panpacific.com/en/hotels-and-resorts/pp-dhaka.html>

- With best regards

**Syed Raihan-UI-Islam**

**Senior Administrative Officer, International Affairs**  
**Daffodil International University**  
102/1, Shukrabad, Dhanmondi, Dhaka-1207, Bangladesh.  
Tel: **+88 02 9138234 (Ext: 237)** | Mob: **+88-01811458865**  
WhatsApp/Viber/Wechat: **+88-01920012744**

On Thu, Jul 5, 2018 at 5:25 PM, Dr. Varun G Menon <[varunmenon@scmsgroup.org](mailto:varunmenon@scmsgroup.org)> wrote:

Dear Mr. Syed Raihan-UI-Islam,

Thank you for the collaboration with SCMS. Please let us know the campus address of DIU where the visit and MoU signing ceremony is planned so that we could arrange the stay in a hotel near the campus. We could see multiple campuses of DIU in the website. It would also be great if you could give the names of few good hotels near your campus.

Thanks and Regards,

**Dr. Varun G Menon**

Associate Professor, Computer Science Engineering  
Exe. Officer, Corporate Relations & International Collaborations  
SCMS School of Engineering and Technology  
Kerala, India-683582  
Office: +91-484-2450330 Mob: +91-8714504684  
Web: <http://www.scmsgroup.org/sset/computer-science-engineering/dr-varun-g-memon>



**SCMS**  
School of Engineering & Technology

On Tue, Jul 3, 2018 at 5:04 PM, International Affairs, DIU <[int@daffodilvarsity.edu.bd](mailto:int@daffodilvarsity.edu.bd)> wrote:

Dear Dr. Varun

Yes Confirm so far. Thank You

- With best regards

**Syed Raihan-UI-Islam**

**Senior Administrative Officer, International Affairs**

**Daffodil International University**

102/1, Shukrabad, Dhanmondi, Dhaka-1207, Bangladesh.

Tel: **+88 02 9138234 (Ext: 237)** | Mob: **+88-01811458865**

WhatsApp/Viber/Wechat: **+88-01920012744**

On Tue, Jul 3, 2018 at 3:57 AM, Dr. Varun G Menon <[varunmenon@scmsgroup.org](mailto:varunmenon@scmsgroup.org)> wrote:

Dear Mr. Syed Raihan-UI-Islam

Thank you for the valuable time. Please confirm the schedule as discussed and agreed earlier. No need to change the schedule. Our flight is scheduled only in the night.

- MoU Signing Ceremony and discussion session on **25th July 2018** from **3PM to 5PM**
- Visit to DIU Permanent Campus and Lunch on the on that day **9AM to 2PM**

Thanks and Regards,

**Dr. Varun G Menon**

Associate Professor, Computer Science Engineering

Exe. Officer, Corporate Relations & International Collaborations

SCMS School of Engineering and Technology

Kerala, India-683582

Office: +91-484-2450330 Mob: +91-8714504684

Web: <http://www.scmsgroup.org/sset/computer-science-engineering/dr-varun-g-menon>



**SCMS**

School of Engineering & Technology

On Sun, Jul 1, 2018 at 12:09 PM, Dr. Varun G Menon <[varunmenon@scmsgroup.org](mailto:varunmenon@scmsgroup.org)> wrote:

Dear Mr. Syed Raihan-UI-Islam,

Please let me know if you can arrange the MoU signing ceremony and discussion on collaboration at DIU on **25th July morning** as we have flight back to India in the evening.

Thank you,

**Dr. Varun G Menon**

Associate Professor-Computer Science Engineering

Exe. Officer-Corporate Relations & International Collaborations

SCMS School of Engineering and Technology

Kerala, India-683582

Office: +91-484-2450330 Mob: +91-8714504684

Web: <http://www.scmsgroup.org/sset/computer-science-engineering/dr-varun-g-menon>



**SCMS**

School of Engineering & Technology

On Thu, Jun 28, 2018 at 1:32 PM, Dr. Varun G Menon <[varunmenon@scmsgroup.org](mailto:varunmenon@scmsgroup.org)> wrote:

Dear Mr. Syed Raihan-UI-Islam,

Thank you for the invitation letter. Looking forward to the meeting. Will update our schedule once we confirm the flight tickets.

Thanks and Regards,

**Dr. Varun G Menon**

Associate Professor-Computer Science Engineering

Exe. Officer-Corporate Relations & International Collaborations

SCMS School of Engineering and Technology

Kerala, India-683582

Office: +91-484-2450330 Mob: +91-8714504684

Web: <http://www.scmsgroup.org/sset/computer-science-engineering/dr-varun-g-menon>



# SCMS

School of Engineering & Technology

On Thu, Jun 28, 2018 at 1:09 PM, International Affairs, DIU <[int@daffodilvarsity.edu.bd](mailto:int@daffodilvarsity.edu.bd)> wrote:

Dear Dr. Varun

Please find the attached letter of Invitation for both of you to visit us for the purpose of the meeting and signing the agreement.

- With best regards

**Syed Raihan-UI-Islam**

**Senior Administrative Officer, International Affairs**

**Daffodil International University**

102/1, Shukrabad, Dhanmondi, Dhaka-1207, Bangladesh.

Tel: **+88 02 9138234 (Ext: 237)** | Mob: **+88-01811458865**

WhatsApp/Viber/Wechat: **+88-01920012744**

On Thu, Jun 28, 2018 at 8:20 AM, Dr. Varun G Menon <[varunmenon@scmsgroup.org](mailto:varunmenon@scmsgroup.org)> wrote:

Dear Mr. Syed Raihan-UI-Islam,

Please see below the details of members visiting DIU on 25th July 2018. Please send us the **invitation letter for the Visa** based on this information.

**Names**

Prof. **PRAMOD PRATHAPACHANDRAN THEVANNOOR**, Vice Chairman, SCMS Group of Educational Institutions.

Dr. **VARUN GIRIJAN MENON**, Associate Professor and International Relations in-charge, SCMS Group of Educational Institutions.

**Address**

SCMS Group of Educational Institutions

SCMS Campus, Prathap Nagar

Muttom, Aluva

Cochin – 683 106, Kerala, INDIA

Let me know any further information required.

Thanks and Regards,

**Dr. Varun G Menon**

Associate Professor-Computer Science Engineering

Exe. Officer-Corporate Relations & International Collaborations

SCMS School of Engineering and Technology

Kerala, India-683582

Office: +91-484-2450330 Mob: +91-8714504684

Web: <http://www.scmsgroup.org/sset/computer-science-engineering/dr-varun-g-menon>



# SCMS

School of Engineering & Technology

On Wed, Jun 27, 2018 at 11:48 AM, International Affairs, DIU <[int@daffodilvarsity.edu.bd](mailto:int@daffodilvarsity.edu.bd)> wrote:

Dear Dr. Varun

Thanks. I am looking forward.

- *With best regards*

**Syed Raihan-UI-Islam**

**Senior Administrative Officer, International Affairs**

**Daffodil International University**

102/1, Shukrabad, Dhanmondi, Dhaka-1207, Bangladesh.

Tel: **+88 02 9138234 (Ext: 237)** | Mob: **+88-01811458865**

WhatsApp/Viber/Wechat: **+88-01920012744**

On Wed, Jun 27, 2018 at 12:15 PM, Dr. Varun G Menon <[varunmenon@scmsgroup.org](mailto:varunmenon@scmsgroup.org)> wrote:

Dear Mr. Syed Raihan-UI-Islam,

Thank you for the information. We will have the visit on 25th July. We will send the details of the members visiting the DIU campus at the earliest.

Regards

Varun

On Wednesday, June 27, 2018, International Affairs, DIU <[int@daffodilvarsity.edu.bd](mailto:int@daffodilvarsity.edu.bd)> wrote:

Dear Dr. Varun,

I have discussed with the Office of the Vice Chancellor

We can arrange the MoU Signing Ceremony and discussion session on **25 July 2018** from **3PM to 5PM**

We can also arrange to visit our Permanent Campus and Lunch on the on that day 9AM to 2PM too.

Let us know if the time and date is convenient for your visit

Looking forward to hearing from you.

- *With best regards*

**Syed Raihan-UI-Islam**

**Senior Administrative Officer, International Affairs**

**Daffodil International University**

102/1, Shukrabad, Dhanmondi, Dhaka-1207, Bangladesh.

Tel: **+88 02 9138234 (Ext: 237)** | Mob: **+88-01811458865**

WhatsApp/Viber/Wechat: **+88-01920012744**

On Wed, Jun 27, 2018 at 11:18 AM, Dr. Varun G Menon <[varunmenon@scmsgroup.org](mailto:varunmenon@scmsgroup.org)> wrote:

Dear Mr. Syed Raihan-UI-Islam,

Can we have the visit between July 24 and 27. Our Vice Chairman is traveling on other dates in July.

Please let me know.

Varun

On Wednesday, June 27, 2018, International Affairs, DIU <[int@daffodilvarsity.edu.bd](mailto:int@daffodilvarsity.edu.bd)> wrote:

Dear Dr. Varun

Can we shift it to the next week I mean in between 15 to 20 July?

- *With best regards*

**Syed Raihan-UI-Islam**

**Senior Administrative Officer, International Affairs**



**Daffodil International University**

102/1, Shukrabad, Dhanmondi, Dhaka-1207, Bangladesh.

Tel: **+88 02 9138234 (Ext: 237)** | Mob: **+88-01811458865**WhatsApp/Viber/Wechat: **+88-01920012744**

On Wed, Jun 27, 2018 at 10:55 AM, Dr. Varun G Menon

<[varunmenon@scmsgroup.org](mailto:varunmenon@scmsgroup.org)> wrote:

Dear Mr. Syed Raihan-UI-Islam,

Thank you for the message. We would like to visit DIU between 10th and 14th July. Please let us know if the date is convenient at your end. Also it would be great if you could send us an Invitation letter which could be produced for the Visa.

Let me know any further details required.

Varun

On Tuesday, June 26, 2018, International Affairs, DIU <[int@daffodilvarsity.edu.bd](mailto:int@daffodilvarsity.edu.bd)> wrote:

Dear Dr. Varun

That is a good idea. Let us know your possible dates to visit us and sign the agreement between both of the universities.

- With best regards

**Syed Raihan-UI-Islam****Senior Administrative Officer, International Affairs****Daffodil International University**

102/1, Shukrabad, Dhanmondi, Dhaka-1207, Bangladesh.

Tel: **+88 02 9138234 (Ext: 237)** | Mob: **+88-01811458865**WhatsApp/Viber/Wechat: **+88-01920012744**

On Tue, Jun 26, 2018 at 10:38 PM, Dr. Varun G Menon

<[varunmenon@scmsgroup.org](mailto:varunmenon@scmsgroup.org)> wrote:

Dear Mr. Syed Raihan-UI-Islam,

Thank you for the collaboration with SCMS. We would like to visit the DIU campus on a favorable date and would like to sign the MoU with the Vice Chancellor at DIU.

We would be more than happy to host the DIU team with Vice Chancellor in our campus in future. Please let me know your thoughts.

Thanks and Regards,

**Dr. Varun G Menon**

Associate Professor-Computer Science Engineering

Exe. Officer-Corporate Relations &amp; International Collaborations

SCMS School of Engineering and Technology

Kerala, India-683582

Office: +91-484-2450330 Mob: +91-8714504684

Web: <http://www.scmsgroup.org/sset/computer-science-engineering/dr-varun-g-menon>**SCMS**

School of Engineering &amp; Technology

On Tue, Jun 26, 2018 at 6:54 PM, International Affairs, DIU

<[int@daffodilvarsity.edu.bd](mailto:int@daffodilvarsity.edu.bd)> wrote:

Dear Dr. Varun

Thank you very much for the agreement final copy. It's fine

May I request you to sign the agreement and send the copies to me either scan copy in my email or 2 original copies in my address given in my email signature

- With best regards

**Syed Raihan-UI-Islam**

**Senior Administrative Officer, International Affairs**

**Daffodil International University**

102/1, Shukrabad, Dhanmondi, Dhaka-1207, Bangladesh.

Tel: **+88 02 9138234 (Ext: 237)** | Mob: **+88-01811458865**

WhatsApp/Viber/Wechat: **+88-01920012744**

On Tue, Jun 26, 2018 at 7:01 PM, Dr. Varun G Menon

<[varunmenon@scmsgroup.org](mailto:varunmenon@scmsgroup.org)> wrote:

Dear Mr. Syed Raihan-UI-Islam,

Thank you for the collaboration with SCMS. Please see the attached MoU draft approved by our Vice Chairman. Please let me know the remaining procedures including the signing of the MoU.

Thanks and Regards,

**Dr. Varun G Menon**

Associate Professor-Computer Science Engineering

Exe. Officer-Corporate Relations & International Collaborations

SCMS School of Engineering and Technology

Kerala, India-683582

Office: +91-484-2450330 Mob: +91-8714504684

Web: <http://www.scmsgroup.org/sset/computer-science-engineering/dr-varun-g-menon>



**SCMS**

School of Engineering & Technology

On Mon, Jun 25, 2018 at 3:55 PM, International Affairs, DIU

<[int@daffodilvarsity.edu.bd](mailto:int@daffodilvarsity.edu.bd)> wrote:

Dear Dr. Varun

Thank you so much for your email and letting us know the update.

- With best regards

**Syed Raihan-UI-Islam**

**Senior Administrative Officer, International Affairs**

**Daffodil International University**

102/1, Shukrabad, Dhanmondi, Dhaka-1207, Bangladesh.

Tel: **+88 02 9138234 (Ext: 237)** | Mob: **+88-01811458865**

WhatsApp/Viber/Wechat: **+88-01920012744**

On Mon, Jun 25, 2018 at 4:14 PM, Dr. Varun G Menon

<[varunmenon@scmsgroup.org](mailto:varunmenon@scmsgroup.org)> wrote:

Dear Mr. Syed Raihan-UI-Islam,

Thank you for the collaboration with SCMS. I have presented the MoU with the Vice Chairman for approval. Once the approval is obtained, I will send back the approved soft copy of the MoU. I have discussed about the Short Term Internships for students from DIU at the Centre for Robotics, SCMS with the Director, Robotics Lab. He has promised to send me The Best Plan for DIU students within two days. I will send you the same at the earliest.

Thanks and Regards,

**Dr. Varun G Menon**

Associate Professor-Computer Science Engineering

Exe. Officer-Corporate Relations & International Collaborations

SCMS School of Engineering and Technology

Kerala, India-683582

Office: +91-484-2450330 Mob: +91-8714504684

Web: <http://www.scmsgroup.org/sset/computer-science-engineering/dr-varun-g-menon>



# SCMS

School of Engineering & Technology

On Sun, Jun 24, 2018 at 12:56 AM, Dr. Varun G Menon

<[varunmenon@scmsgroup.org](mailto:varunmenon@scmsgroup.org)> wrote:

Dear Mr. Syed Raihan-UI-Islam,

Thank you for the email. Will inform the Professor's in charge of the Cyber Security and Robotics research centers about the program plan.

Will sent you the documents soon.

Have a Great Day.

Thanks and Regards,

**Dr. Varun G Menon**

Associate Professor-Computer Science Engineering

Exe. Officer-Corporate Relations & International Collaborations

SCMS School of Engineering and Technology

Kerala, India-683582

Office: +91-484-2450330 Mob: +91-8714504684

Web: <http://www.scmsgroup.org/sset/computer-science-engineering/dr-varun-g-menon>



# SCMS

School of Engineering & Technology

On Sun, Jun 24, 2018 at 12:17 AM, International Affairs, DIU

<[int@daffodilvarsity.edu.bd](mailto:int@daffodilvarsity.edu.bd)> wrote:

Dear Dr, Varun

Thank you very much for your quick response.

It would be great if you can share any proposal or program plan with all details, course plan, costing etc of the Summer internships based on Cyber Security and Robotics so that we could check and show t our students for interest.

Hope to receive the agreement and the program proposals soon.  
Have a great day !

- With best regards

**Syed Raihan-UI-Islam**

**Senior Administrative Officer, International Affairs**

**Daffodil International University**

102/1, Shukrabad, Dhanmondi, Dhaka-1207, Bangladesh.

Tel: **+88 02 9138234 (Ext: 237)** | Mob: **+88-01811458865**

WhatsApp/Viber/Wechat: **+88-01920012744**

On Sun, Jun 24, 2018 at 12:35 AM, Dr. Varun G Menon

<[varunmenon@scmsgroup.org](mailto:varunmenon@scmsgroup.org)> wrote:

Dear Mr. Syed Raihan-UI-Islam,

Thank you for the information about Daffodil International University. Will complete the agreement copy and send you at the earliest.

We have 5 active research groups in our Engineering College that include Centre for Robotics, Centre for Cyber Security, Hydrodynamics and Computational Fluid Dynamics, Antennas and Radiation, Centre for Sustainable Water Technology and Management. Students from your University can do summer internships and short term projects with these project groups.

Besides we also have one of the leading Management Institute in India and also Biotechnology Research Centre.

Thank you for the collaboration. Will send you the document soon.

Regards,

**Dr. Varun G Menon**

Associate Professor-Computer Science Engineering  
Exe. Officer-Corporate Relations & International Collaborations  
SCMS School of Engineering and Technology  
Kerala, India-683582  
Office: +91-484-2450330 Mob: +91-8714504684  
Web: <http://www.scmsgroup.org/sset/computer-science-engineering/dr-varun-g-menon>



**SCMS**  
School of Engineering & Technology

On Sat, Jun 23, 2018 at 6:42 PM, International Affairs, DIU <[int@daffodilvarsity.edu.bd](mailto:int@daffodilvarsity.edu.bd)> wrote:

**Dear Dr. Varun G Menon,**

**Greetings from DIU!**

**Thanks for your email and showing interest in the academic partnership. Yes, we can collaborate in the areas of student exchange programs, faculty exchange programs, summer school research collaborations, joint seminars and conferences.**

**I have attached here the sample agreement copy of DIU, Could you please check and fill it with your information. Besides, I have attached here the fact sheet of DIU where you can check our common details and department.**

**Your CSE, ECE and EEE Department can be a good prospect between both universities. Let us know your observation**

**Looking forward to hearing from you soon.**

*- With best regards*

**Syed Raihan-UI-Islam**

**Senior Administrative Officer, International Affairs**  
**Daffodil International University**  
102/1, Shukrabad, Dhanmondi, Dhaka-1207, Bangladesh.  
Tel: **+88 02 9138234 (Ext: 237)** | Mob: **+88-01811458865**  
WhatsApp/Viber/Wechat: **+88-01920012744**

Respected Mr. Salahuddin Morsalin

Thank you for your time and consideration. Let me introduce as Dr. Varun G Menon, in charge of International Collaborations at SCMS Group of Educational Institutions, India.

We are interested in having academic collaboration with Daffodil International University. Collaboration could be in the areas of student exchange programs, faculty exchange programs, research collaborations, joint seminars and conferences.

We have a dedicate team of faculty and students working in areas like Robotics, Brain Signal Analysis, Computational fluid dynamics. Water Quality Monitoring and Assessment, Limnology, Water Audit, Environmental Remote Sensing , Android Malware Analysis. Research collaborations in these areas is another possibility.

We have academic collaborations with leading international universities like Vrije University-Brussels, Furtwangen University-Germany, University of Applied Sciences Ravensburg Weingarten- Germany, Shimane University-Japan and more.

**Please let me know if we could discuss and take forward this initiative.**

For your information we are the No 1 ranked private educational institutions in the state. You can find more information about our institutions in [www.scmsgroup.org](http://www.scmsgroup.org) and about our Engineering Institute in [www.scmsgroup.org/sset/](http://www.scmsgroup.org/sset/)  
Have a Great Day.

Thanks and Regards,

**Dr. Varun G Menon**

Associate Professor-Computer Science Engineering  
Exe. Officer-Corporate Relations & International Collaborations  
SCMS School of Engineering and Technology  
Kerala, India-683582  
Office: +91-484-2450330 Mob: +91-8714504684  
Web: <http://www.scmsgroup.org/sset/computer-science-engineering/dr-varun-g-memon>



**SCMS**  
School of Engineering & Technology

--

Thanks and Regards,

**Dr. Varun G Menon**

Associate Professor-Computer Science Engineering  
Exe. Officer-Corporate Relations & International Collaborations  
SCMS School of Engineering and Technology

Kerala, India-683582

Office: +91-484-2450330 Mob: +91-8714504684

Web: <http://www.scmsgroup.org/sset/computer-science-engineering/dr-varun-g-menon>



**SCMS**

School of Engineering & Technology

--

Thanks and Regards,

**Dr. Varun G Menon**

Associate Professor-Computer Science Engineering  
Exe. Officer-Corporate Relations & International Collaborations  
SCMS School of Engineering and Technology

Kerala, India-683582

Office: +91-484-2450330 Mob: +91-8714504684

Web: <http://www.scmsgroup.org/sset/computer-science-engineering/dr-varun-g-menon>



**SCMS**

School of Engineering & Technology

--

Thanks and Regards,

**Dr. Varun G Menon**

Associate Professor-Computer Science Engineering  
Exe. Officer-Corporate Relations & International Collaborations  
SCMS School of Engineering and Technology

Kerala, India-683582

Office: +91-484-2450330 Mob: +91-8714504684

Web: <http://www.scmsgroup.org/sset/computer-science-engineering/dr-varun-g-menon>



**SCMS**

School of Engineering & Technology

**International Affairs, DIU** <int@daffodilvarsity.edu.bd>  
To: "Dr. Varun G Menon" <varunmenon@scmsgroup.org>  
Cc: Emran Hossain <emran@daffodilvarsity.edu.bd>, "International, DIU" <international@daffodilvarsity.edu.bd>, "Office of the International Affairs, DIU" <mobility@daffodilvarsity.edu.bd>, Scholarship News <scholarship@daffodilvarsity.edu.bd>, Pramod <pramod@scmsgroup.org>, Kazi Mesbah Ur Rahman <oia@daffodilvarsity.edu.bd>, Indu Nair <indunair@scmsgroup.org>, "Dr. Praveensal C.J." <praveensal@scmsgroup.org>

Wed, Oct 3, 2018 at 1:09 AM

Dear Dr. Varun

I am looking forward to hear from you to activate our partnership through some exchanges and visit plans.

Let us know your observations.

- *With best regards*

**Syed Raihan-UI-Islam**

**Senior Administrative Officer, International Affairs**  
**Daffodil International University**

102/1, Shukrabad, Dhanmondi, Dhaka-1207, Bangladesh.  
Tel: **+88 02 9138234 (Ext: 237)** | Mob: **+88-01811458865**  
WhatsApp/Viber/Wechat: **+88-01920012744**

On Mon, Aug 20, 2018 at 12:57 PM, International Affairs, DIU <int@daffodilvarsity.edu.bd> wrote:

Dear Dr. Varun

Thanks for letting us know. Have great and pleasant times throughout the vacation.

- *With best regards*

**Syed Raihan-UI-Islam**

**Senior Administrative Officer, International Affairs**  
**Daffodil International University**

102/1, Shukrabad, Dhanmondi, Dhaka-1207, Bangladesh.  
Tel: **+88 02 9138234 (Ext: 237)** | Mob: **+88-01811458865**  
WhatsApp/Viber/Wechat: **+88-01920012744**

On Mon, Aug 20, 2018 at 12:44 PM, Dr. Varun G Menon <varunmenon@scmsgroup.org> wrote:

Dear Mr. Syed Raihan-UI-Islam,

Hope you are doing great. Thank you for the information on media coverage and photos of the MoU signing between SCMS and Daffodil International University.

We are having holidays till August 29th. Will send you the program details soon.

I will discuss the possibility of Visiting faculty from SCMS at DIU and will let you know.

Thanks and Regards,

**Dr. Varun G Menon**

Associate Professor & Head of International Relations  
SCMS Group of Educational Institutions  
Cochin, Kerala, India-683106  
Office: +91-484-2450330 Mob: +91-8714504684  
Web: <http://www.scmsgroup.org>



**SCMS**  
GROUP OF EDUCATIONAL INSTITUTIONS

On Sun, Aug 19, 2018 at 3:13 PM, International Affairs, DIU <int@daffodilvarsity.edu.bd> wrote:

Dear Dr. Varun,

Greetings!

Hope you are doing well. We thank you and honorable Vice Chairman for visiting us and sign the agreement. Let us work and plan together to activate the partnership soon.

So far I remember you have some program plans that you were working to send me. Once it's ready please do send us, At the same time, we invite your faculty member to come and teach for short term period as exchange faculty. let us know the possibility

Here I attached some news coverage that published in different national daily newspapers (Both Bangla and English) about the agreement signing between DIU and SCMS group.

Have a great day!

- With best regards

**Syed Raihan-UI-Islam**

**Senior Administrative Officer, International Affairs**  
**Daffodil International University**

102/1, Shukrabad, Dhanmondi, Dhaka-1207, Bangladesh.

Tel: **+88 02 9138234 (Ext: 237)** | Mob: **+88-01811458865**

WhatsApp/Viber/Wechat: **+88-01920012744**

On Fri, Jul 13, 2018 at 1:51 PM, International Affairs, DIU <[int@daffodilvarsity.edu.bd](mailto:int@daffodilvarsity.edu.bd)> wrote:

Dear Dr. Varun

Yes we will arrange pick and drop for you and your Vice Chairman

- With best regards

**Syed Raihan-UI-Islam**

**Senior Administrative Officer, International Affairs**  
**Daffodil International University**

102/1, Shukrabad, Dhanmondi, Dhaka-1207, Bangladesh.

Tel: **+88 02 9138234 (Ext: 237)** | Mob: **+88-01811458865**

WhatsApp/Viber/Wechat: **+88-01920012744**

On Thu, Jul 12, 2018 at 9:58 PM, Dr. Varun G Menon <[varunmenon@scmsgroup.org](mailto:varunmenon@scmsgroup.org)> wrote:

Dear Mr. Syed Raihan-UI-Islam,

Thank you for the collaboration with SCMS.

Kindly see below the details of hotel reserved by us

**Hotel Name: Best Western B/W La Vinci Hotel**  
**Address: 54, Kawran Bazar, Dhaka, Bangladesh 1215**

Please let me know if you would be arranging a pick up from the hotel to the DIU campus. We could start at 1.30 pm from the hotel to the DIU campus for the visit and signing of the MoU.

Thanks and Regards,

**Dr. Varun G Menon**

Associate Professor & Head of International Relations

SCMS Group of Educational Institutions

Cochin, Kerala, India-683106

Office: +91-484-2450330 Mob: +91-8714504684

Web: <http://www.scmsgroup.org>



**SCMS**  
GROUP OF EDUCATIONAL INSTITUTIONS

On Mon, Jul 9, 2018 at 10:58 AM, International Affairs, DIU <[int@daffodilvarsity.edu.bd](mailto:int@daffodilvarsity.edu.bd)> wrote:

Dear Dr. Varun,

Here is the address that i already gave you in whatsapp:

**Daffodil International University**  
102/1, Shukrabad, Dhanmondi, Dhaka-1207  
Bangladesh



some hotels nearby our campus:

<http://www.ambalainn.com>

<https://www.panpacific.com/en/hotels-and-resorts/pp-dhaka.html>

- With best regards

**Syed Raihan-UI-Islam**

**Senior Administrative Officer, International Affairs**

**Daffodil International University**

102/1, Shukrabad, Dhanmondi, Dhaka-1207, Bangladesh.

Tel: **+88 02 9138234 (Ext: 237)** | Mob: **+88-01811458865**

WhatsApp/Viber/Wechat: **+88-01920012744**

On Thu, Jul 5, 2018 at 5:25 PM, Dr. Varun G Menon <[varunmenon@scmsgroup.org](mailto:varunmenon@scmsgroup.org)> wrote:

Dear Mr. Syed Raihan-UI-Islam,

Thank you for the collaboration with SCMS. Please let us know the campus address of DIU where the visit and MoU signing ceremony is planned so that we could arrange the stay in a hotel near the campus. We could see multiple campuses of DIU in the website. It would also be great if you could give the names of few good hotels near your campus.

Thanks and Regards,

**Dr. Varun G Menon**

Associate Professor, Computer Science Engineering

Exe. Officer, Corporate Relations & International Collaborations

SCMS School of Engineering and Technology

Kerala, India-683582

Office: +91-484-2450330 Mob: +91-8714504684

Web: <http://www.scmsgroup.org/sset/computer-science-engineering/dr-varun-g-menon>



**SCMS**

School of Engineering & Technology

On Tue, Jul 3, 2018 at 5:04 PM, International Affairs, DIU <[int@daffodilvarsity.edu.bd](mailto:int@daffodilvarsity.edu.bd)> wrote:

Dear Dr. Varun

Yes Confirm so far. Thank You

- With best regards

**Syed Raihan-UI-Islam**

**Senior Administrative Officer, International Affairs**

**Daffodil International University**

102/1, Shukrabad, Dhanmondi, Dhaka-1207, Bangladesh.

Tel: **+88 02 9138234 (Ext: 237)** | Mob: **+88-01811458865**

WhatsApp/Viber/Wechat: **+88-01920012744**

On Tue, Jul 3, 2018 at 3:57 AM, Dr. Varun G Menon <[varunmenon@scmsgroup.org](mailto:varunmenon@scmsgroup.org)> wrote:

Dear Mr. Syed Raihan-UI-Islam

Thank you for the valuable time. Please confirm the schedule as discussed and agreed earlier. No need to change the schedule. Our flight is scheduled only in the night.

- MoU Signing Ceremony and discussion session on **25th July 2018** from **3PM to 5PM**
- Visit to DIU Permanent Campus and Lunch on the on that day **9AM to 2PM**

Thanks and Regards,

**Dr. Varun G Menon**

Associate Professor, Computer Science Engineering

Exe. Officer, Corporate Relations & International Collaborations

SCMS School of Engineering and Technology

Kerala, India-683582

Office: +91-484-2450330 Mob: +91-8714504684

Web: <http://www.scmsgroup.org/sset/computer-science-engineering/dr-varun-g-menon>



# SCMS

School of Engineering & Technology

On Sun, Jul 1, 2018 at 12:09 PM, Dr. Varun G Menon <[varunmenon@scmsgroup.org](mailto:varunmenon@scmsgroup.org)> wrote:

Dear Mr. Syed Raihan-UI-Islam,

Please let me know if you can arrange the MoU signing ceremony and discussion on collaboration at DIU on **25th July morning** as we have flight back to India in the evening.

Thank you,

**Dr. Varun G Menon**

Associate Professor-Computer Science Engineering

Exe. Officer-Corporate Relations & International Collaborations

SCMS School of Engineering and Technology

Kerala, India-683582

Office: +91-484-2450330 Mob: +91-8714504684

Web: <http://www.scmsgroup.org/sset/computer-science-engineering/dr-varun-g-menon>



# SCMS

School of Engineering & Technology

On Thu, Jun 28, 2018 at 1:32 PM, Dr. Varun G Menon <[varunmenon@scmsgroup.org](mailto:varunmenon@scmsgroup.org)> wrote:

Dear Mr. Syed Raihan-UI-Islam,

Thank you for the invitation letter. Looking forward to the meeting. Will update our schedule once we confirm the flight tickets.

Thanks and Regards,

**Dr. Varun G Menon**

Associate Professor-Computer Science Engineering

Exe. Officer-Corporate Relations & International Collaborations

SCMS School of Engineering and Technology

Kerala, India-683582

Office: +91-484-2450330 Mob: +91-8714504684

Web: <http://www.scmsgroup.org/sset/computer-science-engineering/dr-varun-g-menon>



# SCMS

School of Engineering & Technology

On Thu, Jun 28, 2018 at 1:09 PM, International Affairs, DIU <[int@daffodilvarsity.edu.bd](mailto:int@daffodilvarsity.edu.bd)> wrote:

Dear Dr. Varun

Please find the attached letter of Invitation for both of you to visit us for the purpose of the meeting and signing the agreement.

- With best regards

**Syed Raihan-UI-Islam**

**Senior Administrative Officer, International Affairs**

**Daffodil International University**

102/1, Shukrabad, Dhanmondi, Dhaka-1207, Bangladesh.

Tel: **+88 02 9138234 (Ext: 237)** | Mob: **+88-01811458865**WhatsApp/Viber/Wechat: **+88-01920012744**

On Thu, Jun 28, 2018 at 8:20 AM, Dr. Varun G Menon <[varunmenon@scmsgroup.org](mailto:varunmenon@scmsgroup.org)> wrote:  
Dear Mr. Syed Raihan-UI-Islam,

Please see below the details of members visiting DIU on 25th July 2018. Please send us the **invitation letter for the Visa** based on this information.

**Names**

Prof. **PRAMOD PRATHAPACHANDRAN THEVANNOOR**, Vice Chairman, SCMS Group of Educational Institutions.

Dr. **VARUN GIRIJAN MENON**, Associate Professor and International Relations in-charge, SCMS Group of Educational Institutions.

**Address**

SCMS Group of Educational Institutions  
SCMS Campus, Prathap Nagar  
Muttom, Aluva  
Cochin – 683 106, Kerala, INDIA

Let me know any further information required.

Thanks and Regards,

**Dr. Varun G Menon**

Associate Professor-Computer Science Engineering

Exe. Officer-Corporate Relations &amp; International Collaborations

SCMS School of Engineering and Technology

Kerala, India-683582

Office: +91-484-2450330 Mob: +91-8714504684

Web: <http://www.scmsgroup.org/sset/computer-science-engineering/dr-varun-g-menon>**SCMS**

School of Engineering &amp; Technology

On Wed, Jun 27, 2018 at 11:48 AM, International Affairs, DIU <[int@daffodilvarsity.edu.bd](mailto:int@daffodilvarsity.edu.bd)> wrote:  
Dear Dr. Varun

Thanks. I am looking forward.

- *With best regards*

**Syed Raihan-UI-Islam****Senior Administrative Officer, International Affairs****Daffodil International University**

102/1, Shukrabad, Dhanmondi, Dhaka-1207, Bangladesh.

Tel: **+88 02 9138234 (Ext: 237)** | Mob: **+88-01811458865**WhatsApp/Viber/Wechat: **+88-01920012744**

On Wed, Jun 27, 2018 at 12:15 PM, Dr. Varun G Menon <[varunmenon@scmsgroup.org](mailto:varunmenon@scmsgroup.org)> wrote:

Dear Mr. Syed Raihan-UI-Islam,

Thank you for the information. We will have the visit on 25th July. We will send the details of the members visiting the DIU campus at the earliest.

Regards

Varun

On Wednesday, June 27, 2018, International Affairs, DIU <[int@daffodilvarsity.edu.bd](mailto:int@daffodilvarsity.edu.bd)> wrote:

Dear Dr. Varun,

I have discussed with the Office of the Vice Chancellor

We can arrange the MoU Signing Ceremony and discussion session on **25 July 2018** from **3PM to 5PM**

We can also arrange to visit our Permanent Campus and Lunch on the on that day 9AM to 2PM too.

Let us know if the time and date is convenient for your visit

Looking forward to hearing from you.

- *With best regards*

**Syed Raihan-UI-Islam**

**Senior Administrative Officer, International Affairs**

**Daffodil International University**

102/1, Shukrabad, Dhanmondi, Dhaka-1207, Bangladesh.

Tel: **+88 02 9138234 (Ext: 237)** | Mob: **+88-01811458865**

WhatsApp/Viber/Wechat: **+88-01920012744**

On Wed, Jun 27, 2018 at 11:18 AM, Dr. Varun G Menon <[varunmenon@scmsgroup.org](mailto:varunmenon@scmsgroup.org)> wrote:

Dear Mr. Syed Raihan-UI-Islam,

Can we have the visit between July 24 and 27. Our Vice Chairman is traveling on other dates in July.

Please let me know.

Varun

On Wednesday, June 27, 2018, International Affairs, DIU <[int@daffodilvarsity.edu.bd](mailto:int@daffodilvarsity.edu.bd)> wrote:

Dear Dr. Varun

Can we shift it to the next week I mean in between 15 to 20 July?

- *With best regards*

**Syed Raihan-UI-Islam**

**Senior Administrative Officer, International Affairs**

**Daffodil International University**

102/1, Shukrabad, Dhanmondi, Dhaka-1207, Bangladesh.

Tel: **+88 02 9138234 (Ext: 237)** | Mob: **+88-01811458865**

WhatsApp/Viber/Wechat: **+88-01920012744**

On Wed, Jun 27, 2018 at 10:55 AM, Dr. Varun G Menon <[varunmenon@scmsgroup.org](mailto:varunmenon@scmsgroup.org)> wrote:

Dear Mr. Syed Raihan-UI-Islam,

Thank you for the message. We would like to visit DIU between 10th and 14th July.

Please let us know if the date is convenient at your end. Also it would be great if you could send us an Invitation letter which could be produced for the Visa.

Let me know any further details required.

Varun

On Tuesday, June 26, 2018, International Affairs, DIU <[int@daffodilvarsity.edu.bd](mailto:int@daffodilvarsity.edu.bd)> wrote:

Dear Dr. Varun

That is a good idea. Let us know your possible dates to visit us and sign the agreement between both of the universities.

- *With best regards*

**Syed Raihan-UI-Islam**

**Senior Administrative Officer, International Affairs**

**Daffodil International University**

102/1, Shukrabad, Dhanmondi, Dhaka-1207, Bangladesh.

Tel: **+88 02 9138234 (Ext: 237)** | Mob: **+88-01811458865**

WhatsApp/Viber/Wechat: **+88-01920012744**

On Tue, Jun 26, 2018 at 10:38 PM, Dr. Varun G Menon

<[varunmenon@scmsgroup.org](mailto:varunmenon@scmsgroup.org)> wrote:

Dear Mr. Syed Raihan-UI-Islam,

Thank you for the collaboration with SCMS. We would like to visit the DIU campus on a favorable date and would like to sign the MoU with the Vice Chancellor at DIU.

We would be more than happy to host the DIU team with Vice Chancellor in our campus in future. Please let me know your thoughts.

Thanks and Regards,

**Dr. Varun G Menon**

Associate Professor-Computer Science Engineering

Exe. Officer-Corporate Relations & International Collaborations

SCMS School of Engineering and Technology

Kerala, India-683582

Office: +91-484-2450330 Mob: +91-8714504684

Web: <http://www.scmsgroup.org/sset/computer-science-engineering/dr-varun-g-menon>



**SCMS**

School of Engineering & Technology

On Tue, Jun 26, 2018 at 6:54 PM, International Affairs, DIU

<[int@daffodilvarsity.edu.bd](mailto:int@daffodilvarsity.edu.bd)> wrote:

Dear Dr. Varun

Thank you very much for the agreement final copy. It's fine

May I request you to sign the agreement and send the copies to me either scan copy in my email or 2 original copies in my address given in my email signature

- With best regards

**Syed Raihan-UI-Islam**

**Senior Administrative Officer, International Affairs**

**Daffodil International University**

102/1, Shukrabad, Dhanmondi, Dhaka-1207, Bangladesh.

Tel: **+88 02 9138234 (Ext: 237)** | Mob: **+88-01811458865**

WhatsApp/Viber/Wechat: **+88-01920012744**

On Tue, Jun 26, 2018 at 7:01 PM, Dr. Varun G Menon

<[varunmenon@scmsgroup.org](mailto:varunmenon@scmsgroup.org)> wrote:

Dear Mr. Syed Raihan-UI-Islam,

Thank you for the collaboration with SCMS. Please see the attached MoU draft approved by our Vice Chairman. Please let me know the remaining procedures including the signing of the MoU.

Thanks and Regards,

**Dr. Varun G Menon**

Associate Professor-Computer Science Engineering

Exe. Officer-Corporate Relations & International Collaborations

SCMS School of Engineering and Technology

Kerala, India-683582

Office: +91-484-2450330 Mob: +91-8714504684

Web: <http://www.scmsgroup.org/sset/computer-science-engineering/dr-varun-g-menon>



**SCMS**  
School of Engineering & Technology

On Mon, Jun 25, 2018 at 3:55 PM, International Affairs, DIU  
<[int@daffodilvarsity.edu.bd](mailto:int@daffodilvarsity.edu.bd)> wrote:

Dear Dr. Varun

Thank you so much for your email and letting us know the update.

- With best regards

**Syed Raihan-UI-Islam**

**Senior Administrative Officer, International Affairs**  
**Daffodil International University**

102/1, Shukrabad, Dhanmondi, Dhaka-1207, Bangladesh.

Tel: **+88 02 9138234 (Ext: 237)** | Mob: **+88-01811458865**

WhatsApp/Viber/Wechat: **+88-01920012744**

On Mon, Jun 25, 2018 at 4:14 PM, Dr. Varun G Menon  
<[varunmenon@scmsgroup.org](mailto:varunmenon@scmsgroup.org)> wrote:

Dear Mr. Syed Raihan-UI-Islam,

Thank you for the collaboration with SCMS. I have presented the MoU with the Vice Chairman for approval. Once the approval is obtained, I will send back the approved soft copy of the MoU. I have discussed about the Short Term Internships for students from DIU at the Centre for Robotics, SCMS with the Director, Robotics Lab. He has promised to send me The Best Plan for DIU students within two days. I will send you the same at the earliest.

Thanks and Regards,

**Dr. Varun G Menon**

Associate Professor-Computer Science Engineering  
Exe. Officer-Corporate Relations & International Collaborations  
SCMS School of Engineering and Technology  
Kerala, India-683582

Office: +91-484-2450330 Mob: +91-8714504684

Web: <http://www.scmsgroup.org/sset/computer-science-engineering/dr-varun-g-menon>



**SCMS**  
School of Engineering & Technology

On Sun, Jun 24, 2018 at 12:56 AM, Dr. Varun G Menon  
<[varunmenon@scmsgroup.org](mailto:varunmenon@scmsgroup.org)> wrote:

Dear Mr. Syed Raihan-UI-Islam,

Thank you for the email. Will inform the Professor's in charge of the Cyber Security and Robotics research centers about the program plan.

Will sent you the documents soon.

Have a Great Day.

Thanks and Regards,

**Dr. Varun G Menon**

Associate Professor-Computer Science Engineering  
Exe. Officer-Corporate Relations & International  
Collaborations  
SCMS School of Engineering and Technology  
Kerala, India-683582  
Office: +91-484-2450330 Mob: +91-8714504684  
Web: <http://www.scmsgroup.org/sset/computer-science-engineering/dr-varun-g-menon>



**SCMS**  
School of Engineering & Technology

On Sun, Jun 24, 2018 at 12:17 AM, International Affairs, DIU  
<[int@daffodilvarsity.edu.bd](mailto:int@daffodilvarsity.edu.bd)> wrote:

Dear Dr, Varun

Thank you very much for your quick response.

It would be great if you can share any proposal or program plan with all details, course plan, costing etc of the Summer internships based on Cyber Security and Robotics so that we could check and show t our students for interest.

Hope to receive the agreement and the program proposals soon.  
Have a great day !

- *With best regards*

**Syed Raihan-UI-Islam**

**Senior Administrative Officer**, [International Affairs](#)  
[Daffodil International University](#)

102/1, Shukrabad, Dhanmondi, Dhaka-1207, Bangladesh.

Tel: **+88 02 9138234 (Ext: 237)** | Mob: +88-

**01811458865**

WhatsApp/Viber/Wechat: **+88-01920012744**

On Sun, Jun 24, 2018 at 12:35 AM, Dr. Varun G Menon

<[varunmenon@scmsgroup.org](mailto:varunmenon@scmsgroup.org)> wrote:

Dear Mr. Syed Raihan-UI-Islam,

Thank you for the information about Daffodil International University. Will complete the agreement copy and send you at the earliest.

We have 5 active research groups in our Engineering College that include Centre for Robotics, Centre for Cyber Security, Hydrodynamics and Computational Fluid Dynamics, Antennas and Radiation, Centre for Sustainable Water Technology and Management. Students from your University can do summer internships and short term projects with these project groups.

Besides we also have one of the leading Management Institute in India and also Biotechnology Research Centre.

Thank you for the collaboration. Will send you the document soon.

Regards,

**Dr. Varun G Menon**

Associate Professor-Computer Science Engineering  
Exe. Officer-Corporate Relations & International  
Collaborations

SCMS School of Engineering and Technology  
Kerala, India-683582

Office: +91-484-2450330 Mob: +91-8714504684  
Web: <http://www.scmsgroup.org/sset/computer-science-engineering/dr-varun-g-menon>



# SCMS

School of Engineering & Technology

On Sat, Jun 23, 2018 at 6:42 PM, International Affairs, DIU  
<[int@daffodilvarsity.edu.bd](mailto:int@daffodilvarsity.edu.bd)> wrote:

**Dear Dr. Varun G Menon,**

**Greetings from DIU!**

**Thanks for your email and showing interest in the academic partnership. Yes, we can collaborate in the areas of student exchange programs, faculty exchange programs, summer school research collaborations, joint seminars and conferences.**

**I have attached here the sample agreement copy of DIU, Could you please check and fill it with your information. Besides, I have attached here the fact sheet of DIU where you can check our common details and department.**

**Your CSE, ECE and EEE Department can be a good prospect between both universities. Let us know your observation**

**Looking forward to hearing from you soon.**

*- With best regards*

**Syed Raihan-UI-Islam**

**Senior Administrative Officer, International Affairs  
Daffodil International University**

102/1, Shukrabad, Dhanmondi, Dhaka-1207, Bangladesh.

Tel: **+88 02 9138234 (Ext: 237)** | Mob: +88-

**01811458865**

WhatsApp/Viber/Wechat: **+88-01920012744**

Respected Mr. Salahuddin Morsalin

Thank you for your time and consideration. Let me introduce as Dr. Varun G Menon, in charge of International Collaborations at SCMS Group of Educational Institutions, India.

We are interested in having academic collaboration with Daffodil International University. Collaboration could be in the areas of student exchange programs, faculty exchange programs, research collaborations, joint seminars and conferences.

We have a dedicate team of faculty and students working in areas like Robotics, Brain Signal Analysis, Computational fluid dynamics. Water Quality Monitoring and Assessment, Limnology, Water Audit, Environmental Remote Sensing , Android Malware Analysis. Research collaborations in these areas is another possibility.

We have academic collaborations with leading international universities like Vrije University-Brussels, Furtwangen University-Germany, University of Applied Sciences Ravensburg Weingarten- Germany, Shimane University-Japan and more.



**Please let me know if we could discuss and take forward this initiative.**

For your information we are the No 1 ranked private educational institutions in the state. You can find more information about our institutions in [www.scmsgroup.org](http://www.scmsgroup.org) and about our Engineering Institute in [www.scmsgroup.org/sset/](http://www.scmsgroup.org/sset/)  
Have a Great Day.

Thanks and Regards,

**Dr. Varun G Menon**

Associate Professor-Computer Science Engineering  
Exe. Officer-Corporate Relations & International Collaborations  
SCMS School of Engineering and Technology  
Kerala, India-683582  
Office: +91-484-2450330 Mob: +91-8714504684  
Web: <http://www.scmsgroup.org/sset/computer-science-engineering/dr-varun-g-menon>



**SCMS**

School of Engineering & Technology

--

Thanks and Regards,

**Dr. Varun G Menon**

Associate Professor-Computer Science Engineering  
Exe. Officer-Corporate Relations & International Collaborations  
SCMS School of Engineering and Technology  
Kerala, India-683582  
Office: +91-484-2450330 Mob: +91-8714504684  
Web: <http://www.scmsgroup.org/sset/computer-science-engineering/dr-varun-g-menon>



**SCMS**

School of Engineering & Technology

--

Thanks and Regards,

**Dr. Varun G Menon**

Associate Professor-Computer Science Engineering  
Exe. Officer-Corporate Relations & International Collaborations  
SCMS School of Engineering and Technology  
Kerala, India-683582  
Office: +91-484-2450330 Mob: +91-8714504684  
Web: <http://www.scmsgroup.org/sset/computer-science-engineering/dr-varun-g-menon>



**SCMS**  
School of Engineering & Technology

--  
Thanks and Regards,

**Dr. Varun G Menon**

Associate Professor-Computer Science Engineering  
Exe. Officer-Corporate Relations & International Collaborations  
SCMS School of Engineering and Technology  
Kerala, India-683582  
Office: +91-484-2450330 Mob: +91-8714504684  
Web: <http://www.scmsgroup.org/sset/computer-science-engineering/dr-varun-g-menon>



**SCMS**  
School of Engineering & Technology

---

**Dr. Varun G Menon** <varunmenon@scmsgroup.org>

Thu, Nov 1, 2018 at 9:09 AM

To: "International Affairs, DIU" <int@daffodilvarsity.edu.bd>

Cc: Emran Hossain <emran@daffodilvarsity.edu.bd>, "International, DIU" <international@daffodilvarsity.edu.bd>, "Office of the International Affairs, DIU" <mobility@daffodilvarsity.edu.bd>, Scholarship News <scholarship@daffodilvarsity.edu.bd>, Pramod <pramod@scmsgroup.org>, Kazi Mesbah Ur Rahman <oia@daffodilvarsity.edu.bd>, "Dr. Praveensal C.J." <praveensal@scmsgroup.org>, Sunil Jacob <suniljacob@scmsgroup.org>, Gopakumar S <gopakumars@scmsgroup.org>

Dear Mr. Syed Raihan-UI-Islam,

Thank you for the partnership with SCMS.

As requested, please see the attached program plan of the Internship program at Centre for Robotics, SCMS School of Engineering and Technology.

The program has been customized for the Engineering students at DIU.

Please feel free to contact me for any clarifications.

Thanks and Regards,

**Dr. Varun G Menon**

Associate Professor and Head of International Relations  
SCMS School of Engineering and Technology  
Karukutty, Ernakulam, Kerala, India - 683 582

[Quoted text hidden]

---

 **Internship at SCMS for Daffodil University Students.pdf**  
265K

---

**Sunil Jacob** <suniljacob@scmsgroup.org>

Thu, Nov 1, 2018 at 9:09 AM

To: Varun Menon G <varunmenon@scmsgroup.org>

Cc: int@daffodilvarsity.edu.bd, emran@daffodilvarsity.edu.bd, international@daffodilvarsity.edu.bd, mobility@daffodilvarsity.edu.bd, scholarship@daffodilvarsity.edu.bd, Pramod P Thevannoor <pramod@scmsgroup.org>, oia@daffodilvarsity.edu.bd, "Dr. Praveensal C.J." <praveensal@scmsgroup.org>, Gopakumar S <gopakumars@scmsgroup.org>

Received, thank you.

[Quoted text hidden]

--

Regards,  
Dr. Sunil Jacob  
Director SCMS Centre for Robotics  
Professor Electronics and Communication Engineering Department



**SCMS**  
School of Engineering & Technology

SCMS School of Engineering & Technology  
Karukutty, Cochin - 683 582  
Kerala  
India

---

**International Affairs, DIU** <int@daffodilvarsity.edu.bd>

Tue, Dec 4, 2018 at 8:35 PM

To: "Dr. Varun G Menon" <varunmenon@scmsgroup.org>

Cc: Emran Hossain <emran@daffodilvarsity.edu.bd>, "International, DIU" <international@daffodilvarsity.edu.bd>, "Office of the International Affairs, DIU" <mobility@daffodilvarsity.edu.bd>, Scholarship News <scholarship@daffodilvarsity.edu.bd>, Pramod <pramod@scmsgroup.org>, Kazi Mesbah Ur Rahman <oia@daffodilvarsity.edu.bd>, "Dr. Praveensal C.J." <praveensal@scmsgroup.org>, suniljacob@scmsgroup.org, gopakumars@scmsgroup.org

Dear Dr. Varun,

I got feedback from the departments

We can send a group of 4 students (after successful application by students) to you to attend the program.

The Department suggested the following with industry or factory tour:

Lesson 1: Introduction  
Lesson 2: Sensors, actuators, and drivers  
Lesson 3: Embedded robot controller, I/O interfacing, and PWM amplifiers  
Lesson 4: Controller software and sensor inputs  
Lesson 5: ADC and sensor-based controls  
Lesson 6: Algorithms and planning strategies for specific tasks  
Lesson 7: Kinematics, differential motion and navigation

As suggested, we would like to send a faculty member with the 4 students who can guide them during the stay as well as if you can accept him/her as an exchange faculty to teach in the SCMS for 2 weeks. Do you think it's possible?

At the same time, the cost of the program is 300 USD for each participant. It would be more possible to get students if you minimize the cost such as not more than 200 USD.

Looking forward to hearing from you.

- *With best regards*

**Syed Raihan-UI-Islam**

**Senior Administrative Officer, International Affairs**

**Daffodil International University**

102/1, Shukrabad, Dhanmondi, Dhaka-1207, Bangladesh.

Tel: +88 02 9138234 (Ext: 237) | Mob: +88-01811458865  
 WhatsApp/Viber/Wechat: +88-01920012744



[Quoted text hidden]

**Dr. Varun G Menon** <varunmenon@scmsgroup.org> Wed, Dec 5, 2018 at 9:36 AM  
 To: "International Affairs, DIU" <int@daffodilvarsity.edu.bd>  
 Cc: Emran Hossain <emran@daffodilvarsity.edu.bd>, "International, DIU" <international@daffodilvarsity.edu.bd>, "Office of the International Affairs, DIU" <mobility@daffodilvarsity.edu.bd>, Scholarship News <scholarship@daffodilvarsity.edu.bd>, Pramod <pramod@scmsgroup.org>, Kazi Mesbah Ur Rahman <oia@daffodilvarsity.edu.bd>, "Dr. Praveensal C.J." <praveensal@scmsgroup.org>, Sunil Jacob <suniljacob@scmsgroup.org>, Gopakumar S <gopakumars@scmsgroup.org>

Dear Mr. Syed Raihan-UI-Islam,  
 Thank you for the message. Will discuss with the Director and get back to you at the earliest.  
 Thanks and Regards,  
 Varun

**Dr. Varun G Menon**  
 Associate Professor-Computer Science Engineering  
 Corporate Relations and International Collaborations-in charge  
 SCMS School of Engineering and Technology  
 Karukutty, Ernakulam, Kerala, India - 683 582  
 Office: +91-484-2450330 Mob: +91-8714504684  
 Web: <http://www.scmsgroup.org>



**SCMS**  
 GROUP OF EDUCATIONAL INSTITUTIONS

[Quoted text hidden]

**International Affairs, DIU** <int@daffodilvarsity.edu.bd> Tue, Dec 18, 2018 at 3:04 AM  
 To: "Dr. Varun G Menon" <varunmenon@scmsgroup.org>  
 Cc: Emran Hossain <emran@daffodilvarsity.edu.bd>, "International, DIU" <international@daffodilvarsity.edu.bd>, "Office of the International Affairs, DIU" <mobility@daffodilvarsity.edu.bd>, Scholarship News <scholarship@daffodilvarsity.edu.bd>, Pramod <pramod@scmsgroup.org>, Kazi Mesbah Ur Rahman <oia@daffodilvarsity.edu.bd>, "Dr. Praveensal C.J." <praveensal@scmsgroup.org>, Sunil Jacob <suniljacob@scmsgroup.org>, Gopakumar S <gopakumars@scmsgroup.org>

Dear Dr. Varun,  
 How are you? Any update of the program if you discussed? Looking forward to hear from you.

- With best regards

**Syed Raihan-UI-Islam**  
**Senior Administrative Officer, International Affairs**  
**Daffodil International University**  
 102/1, Shukrabad, Dhanmondi, Dhaka-1207, Bangladesh.  
 Tel: +88 02 9138234 (Ext: 237) | Mob: +88-01811458865  
 WhatsApp/Viber/Wechat: +88-01920012744

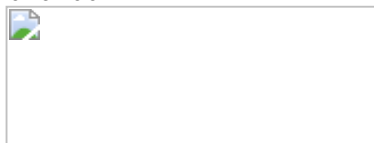

[Quoted text hidden]

**Dr. Varun G Menon** <varunmenon@scmsgroup.org> Thu, Jan 10, 2019 at 11:04 AM  
 To: "International Affairs, DIU" <int@daffodilvarsity.edu.bd>

Cc: Emran Hossain <emran@daffodilvarsity.edu.bd>, "International, DIU" <international@daffodilvarsity.edu.bd>, "Office of the International Affairs, DIU" <mobility@daffodilvarsity.edu.bd>, Scholarship News <scholarship@daffodilvarsity.edu.bd>, Pramod <pramod@scmsgroup.org>, Kazi Mesbah Ur Rahman <oia@daffodilvarsity.edu.bd>, "Dr. Praveensal C.J." <praveensal@scmsgroup.org>, Sunil Jacob <suniljacob@scmsgroup.org>, Gopakumar S <gopakumars@scmsgroup.org>

Dear Mr. Syed Raihan-UI-Islam,

Thank you for the collaboration with SCMS.

The syllabus communicated by your Department looks fine. The Internship at SCMS Center for Robotics would mainly focus on implementation of projects based on the syllabus topics. As we have also planned a few advanced topics, It would be great to have students who have good understanding of the basics.

We would be happy to welcome one faculty form DIU along with the students for the program. The faculty could also share ideas with our students. We will take care of accommodation and food of the faculty.

We have already made the arrangements for the program this year with the cost of 300 USD. We will definitely look into your suggestions regarding the cost in the subsequent years.

The tentative date planned for the start of the program is 17th June 2019.

Looking forward to your reply,

Thank you

Dr. Varun

[Quoted text hidden]

**International Affairs, DIU** <int@daffodilvarsity.edu.bd>

Sun, Jan 13, 2019 at 6:35 PM

To: "Dr. Varun G Menon" <varunmenon@scmsgroup.org>

Cc: Emran Hossain <emran@daffodilvarsity.edu.bd>, "International, DIU" <international@daffodilvarsity.edu.bd>, "Office of the International Affairs, DIU" <mobility@daffodilvarsity.edu.bd>, Scholarship News <scholarship@daffodilvarsity.edu.bd>, Pramod <pramod@scmsgroup.org>, Kazi Mesbah Ur Rahman <oia@daffodilvarsity.edu.bd>, "Dr. Praveensal C.J." <praveensal@scmsgroup.org>, Sunil Jacob <suniljacob@scmsgroup.org>, Gopakumar S <gopakumars@scmsgroup.org>

**Dear Dr. Varun,**

Good to hear from you. Thanks for coming back with udapted information. We are passing the information to our relevant department with your mentioned date plan. Hope the course plan will be redesigned as per department's suggestion that i sent to you.

We hope to send a group of students along with an Excahnge Faculty Member.

- *With best regards*

**Syed Raihan-UI-Islam**

**Senior Administrative Officer, International Affairs**

**Daffodil International University**

102/1, Shukrabad, Dhanmondi, Dhaka-1207, Bangladesh.

Tel: **+88 02 9138234 (Ext: 237)** | Mob: **+88-01811458865**

WhatsApp/Viber/Wechat: **+88-01920012744**

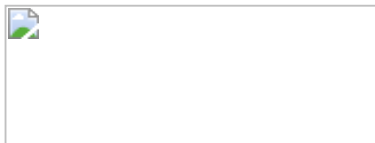

[Quoted text hidden]

**Dr. Varun G Menon** <varunmenon@scmsgroup.org>

Thu, Apr 25, 2019 at 8:59 PM

To: "International Affairs, DIU" <int@daffodilvarsity.edu.bd>

Cc: Emran Hossain <emran@daffodilvarsity.edu.bd>, "International, DIU" <international@daffodilvarsity.edu.bd>, "Office of the International Affairs, DIU" <mobility@daffodilvarsity.edu.bd>, Scholarship News <scholarship@daffodilvarsity.edu.bd>, Pramod <pramod@scmsgroup.org>, Kazi Mesbah Ur Rahman <oia@daffodilvarsity.edu.bd>, "Dr. Praveensal C.J." <praveensal@scmsgroup.org>, Sunil Jacob <suniljacob@scmsgroup.org>, Gopakumar S <gopakumars@scmsgroup.org>, Vinoj Pg <vinojpg@gmail.com>, "Sreeja M." <m.sreeja79@gmail.com>, Asha Jacob <ashajacob@scmsgroup.org>

Dear Syed Raihan-UI-Islam,

Thank you for sharing the details thorough Skype video call and confirming your participation in the Internship program to be conducted at Center for Robotics, SCMS School of Engineering and Technology. I am summarizing the discussion we had through the Skype call,

- Four students and a faculty member would be reaching Cochin by June 16th 2019.

- The Internship program led by Dr. Sunil Jacob, Director Center for Robotics would start at SCMS School of Engineering and Technology on June 17th Monday.
- Faculty member from DIU would be engaging few sessions for faculty and students at SCMS Group of Educational Institutions
- The course would start from an Intermediate level as requested by the DIU team.
- SCMS would be providing the invitation letters to the students and faculty for visa application.
- Four students would be paying an amount of 300 USD each towards accommodation, food and local transportation that would be arranged by SCMS.
- Further details to be discussed in the next Skype Video call/meeting.

I look forward to the full name (Name as in passport) of the students and faculty for providing the Invitation letters. Also please attach the passport copies of all the members.

Thank you,

**Dr. Varun G Menon**  
**Associate Professor-Computer Science Engineering**  
**Corporate Relations and International Collaborations-in charge**  
**ACM Distinguished Speaker**  
**Guest Editor-Journal of Supercomputing, Springer**  
**SCMS School of Engineering and Technology**  
**SCMS Group of Educational Institutions**  
**Karukutty, Ernakulam, Kerala, India - 683 576**  
**Office: +91-484-2450330 Mob: +91-8714504684**  
**Web: <http://www.scmsgroup.org>**



[Quoted text hidden]

--

Thanks and Regards,

---

**International Affairs, DIU** <int@daffodilvarsity.edu.bd>

Thu, May 2, 2019 at 1:01 PM

To: "Dr. Varun G Menon" <varunmenon@scmsgroup.org>

Cc: Emran Hossain <emran@daffodilvarsity.edu.bd>, "International, DIU" <international@daffodilvarsity.edu.bd>, "Office of the International Affairs, DIU" <mobility@daffodilvarsity.edu.bd>, Scholarship News <scholarship@daffodilvarsity.edu.bd>, Pramod <pramod@scmsgroup.org>, Kazi Mesbah Ur Rahman <oia@daffodilvarsity.edu.bd>, "Dr. Praveensal C.J."

<praveensal@scmsgroup.org>, Sunil Jacob <suniljacob@scmsgroup.org>, Gopakumar S <gopakumars@scmsgroup.org>, Vinoj Pg <vinojpg@gmail.com>, "Sreeja M." <m.sreeja79@gmail.com>, Asha Jacob <ashajacob@scmsgroup.org>

**Dear Dr. Varun,**

Greetings!

Please find the attached list of students and faculty member who will be joining in your university for the **Robotics Camp from 17 June 2019**.

I also attached the CV of **Khandker M Qaiduzzaman Lecturer | Department of Software Engineering** who will be the team leader and also possibly take some classes as per your arrangement.

You can issue the letter of invitation for them according to their information

We can set up next skype call during the 2nd week of May since we are now having semester break and all the students are out of campus.

I will be waiting to hear from you.

- *With best regards*

**Syed Raihan-UI-Islam**  
**Assistant Director, International Affairs**  
**Daffodil International University**

Address: Daffodil Tower-4, 102/1 Shukrabad, Dhanmondi, Dhaka-1207, Bangladesh.

Tel: **+88 02 9138234 (Ext: 237)** | Mob: **+88-01811458865**

WhatsApp/Viber/Wechat/Telegram: **+88-01920012744**



---

**2 attachments**

 **Deligate Details.docx**  
15K

 **CV-Khandker-M-Qaiduzzaman.pdf**  
168K

---

**Dr. Varun G Menon** <varunmenon@scmsgroup.org> Tue, May 14, 2019 at 3:03 PM  
 To: "International Affairs, DIU" <int@daffodilvarsity.edu.bd>  
 Cc: Emran Hossain <emran@daffodilvarsity.edu.bd>, "International, DIU" <international@daffodilvarsity.edu.bd>, "Office of the International Affairs, DIU" <mobility@daffodilvarsity.edu.bd>, Scholarship News <scholarship@daffodilvarsity.edu.bd>, Pramod <pramod@scmsgroup.org>, Kazi Mesbah Ur Rahman <oia@daffodilvarsity.edu.bd>, "Dr. Praveensal C.J." <praveensal@scmsgroup.org>, Sunil Jacob <suniljacob@scmsgroup.org>, Gopakumar S <gopakumars@scmsgroup.org>, Vinoj Pg <vinojpg@gmail.com>, "Sreeja M." <m.sreeja79@gmail.com>

Dear Mr Syed,  
 Please see the attached **Invitation Letters** for the students and faculty from DIU visiting SCMS in June.  
 Dr. Sunil Jacob, Director Center for Robotics is available for Skype call this week. Please let me know a suitable time.  
 Let me know any further help or information required.

Thank you,  
 Varun

[Quoted text hidden]

--

Thanks and Regards,

**Dr. Varun G Menon**  
**Associate Professor-Computer Science Engineering**  
**Corporate Relations and International Collaborations-in charge**  
**ACM Distinguished Speaker**  
**Guest Editor-Journal of Supercomputing, Springer**  
**SCMS School of Engineering and Technology**  
**SCMS Group of Educational Institutions**  
**Karukutty, Ernakulam, Kerala, India - 683 576**  
**Office: +91-484-2450330 Mob: +91-8714504684**  
**Web: <http://www.scmsgroup.org>**



---

**2 attachments**

 **DIU Faculty\_Invitation.pdf**  
260K

 **DIU Students\_Invitation.pdf**  
1007K

---

**International Affairs, DIU** <int@daffodilvarsity.edu.bd> Tue, May 14, 2019 at 4:48 PM  
 To: "Dr. Varun G Menon" <varunmenon@scmsgroup.org>  
 Cc: Emran Hossain <emran@daffodilvarsity.edu.bd>, "International, DIU" <international@daffodilvarsity.edu.bd>, "Office of the International Affairs, DIU" <mobility@daffodilvarsity.edu.bd>, Scholarship News <scholarship@daffodilvarsity.edu.bd>, Pramod <pramod@scmsgroup.org>, Kazi Mesbah Ur Rahman <oia@daffodilvarsity.edu.bd>, "Dr. Praveensal C.J." <praveensal@scmsgroup.org>, Sunil Jacob <suniljacob@scmsgroup.org>, Gopakumar S <gopakumars@scmsgroup.org>, Vinoj Pg <vinojpg@gmail.com>, "Sreeja M." <m.sreeja79@gmail.com>

Dr. Varun

Thanks for sending the letters. We will set the meetings soon.

Let me discuss with students and the faculty member.

[Quoted text hidden]

--

[Quoted text hidden]

---

**"Office of the International Affairs, DIU"** <mobility@daffodilvarsity.edu.bd>

Mon, Jun 10, 2019 at 12:54 PM

To: "Dr. Varun G Menon" <varunmenon@scmsgroup.org>

Cc: Syed Raihan-UI-Islam <int@daffodilvarsity.edu.bd>

Dear Dr. Varun,

Greetings of the day!

Hopefully, you are doing well. Our four students deposit their registration fee for the program. May I request you to issue an invoice for registration fee payment. Please include the following accounts/bank information in the invoice that we can transfer the registration fee.

1. Account Name
2. Account No
3. Bank Name
4. Branch Name
5. Bank Address
6. SWIFT Code
7. Bank Tel. No
8. Total Amount

We are looking forward to hearing from you.

*Best regards,*

-----  
**Md. Nazmul Islam**

**Assistant Administrative Officer**

Office of the International Affairs

Daffodil International University (DIU)

102/1 Sukrabad, Mirpur Road,

Dhanmondi, Dhaka-1207, Bangladesh.

📞 +8801847334763

☎ +88 02 9138234 (Ext-233)

✉ [mobility@daffodilvarsity.edu.bd](mailto:mobility@daffodilvarsity.edu.bd)

🌐 [www.daffodilvarsity.edu.bd](http://www.daffodilvarsity.edu.bd)

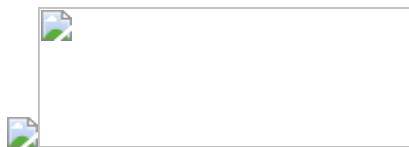

[Quoted text hidden]

---

**Dr. Varun G Menon** <varunmenon@scmsgroup.org>

Mon, Jun 10, 2019 at 6:44 PM

To: "Office of the International Affairs, DIU" <mobility@daffodilvarsity.edu.bd>

Dear Sir,

Thank you for the email. We will generate the Invoice and share the details with you soon.

Regards,

Dr. Varun

[Quoted text hidden]

---

**Dr. Varun G Menon** <varunmenon@scmsgroup.org>

Tue, Jun 11, 2019 at 10:21 AM

To: Pramod <pramod@scmsgroup.org>

Dear Sir,

Please see the below email requesting Invoice and payment details for the Internship program by Daffodil University office.

Thank you,

Varun

[Quoted text hidden]







Varun Menon G &lt;varunmenon@scmsgroup.org&gt;

---

## Internship Opportunities for Daffodil International University

5 messages

---

**Md. Ziaul Haque Zim 181-15-11333** <ziaul15-1133@diu.edu.bd>  
To: "varunmenon@scmsgroup.org" <varunmenon@scmsgroup.org>

Mon, Mar 4, 2019 at 7:23 PM

My name is Md Ziaul Haque Zim, and I'm a undergraduate student in B.Sc. in Computer Science & Engineering at the Daffodil International University, Bangladesh. This semester I'm in One semester exchange program in Computer Science & Technology at Saint Petersburg Electrotechnical University – ETU "LETI", Saint Petersburg, Russia.

I'm very much interested in Mechatronics, AI, Robotics, Automation. I'm looking for a internship and Centre for Robotics, SCMS School of Engineering and Technology caught my eye as a place where I could really make a difference.

I heard about Centre for Robotics, SCMS School of Engineering and Technology a few days ago as a institution that's researching and backing new, innovative institution in multiple fields in Robotics. As a Computer Science & Engineering student, Automation, AI, Machine Learning, Image Processing has always been a passion of mine. In the past, I've big experience at **Daffodil International University Robotics Club** that worked with startups looking to find developing and contribute my knowledge in robotics in their projects. For the past one years, I've taken some classes in "Micro Controller & Robotic Remote Controlled Car" that stress the importance of research, logistics, and debate before making a major decision in Robotics projects. Because of my background and natural interest in Automation, Robotics & AI, I'm writing to see if "*Centre for Robotics, SCMS School of Engineering and Technology*" is hiring for student internships in the research and technological development sector. I'm confident that I could perform with excellence as a Centre for Robotics intern.

I attached some document (such as Passport scan copy, student ID card, DIU & ETU "LETI" exchange program letter). Centre for Robotics, SCMS School of Engineering and Technology is at the top of my list of internships and I am very interested in hearing more about it. Thank you very much for your time, and I look forward to talking with you.

Best,

Md. Ziaul Haque Zim  
Studies B.Sc. in Computer Science And Engineering  
Daffodil International University, Bangladesh.

---

3 attachments

**ID.jpg**  
2259K



**Passport.jpg**  
1240K



**Letter of Admission Mr Zim.jpg**  
545K

**Dr. Varun G Menon** <varunmenon@scmsgroup.org>  
To: "Md. Ziaul Haque Zim 181-15-11333" <ziaul15-1133@diu.edu.bd>

Sun, Mar 10, 2019 at 7:39 PM

Dear Md Ziaul Haque Zim

Thank you for the email and the interest in the Internship program. I am currently traveling and back at college on Wednesday. I will reply in detail then. Our program starts by June 17th. We can also plan a Skype session between you and the Director of Robotics Center. Will take forward your request on Wednesday.

Thank you  
Varun

[Quoted text hidden]

**Md. Ziaul Haque Zim 181-15-11333** <ziaul15-1133@diu.edu.bd>  
To: "Dr. Varun G Menon" <varunmenon@scmsgroup.org>

Mon, Mar 18, 2019 at 11:38 PM

Dear Sir,

I'm very glad and pleasure to received your reply. I'm replying lately because recently I contact Saint Petersburg Electrotechnical University - ETU "LETI" authority after received your email, for knowing the official ending date of this program and they replied it was **30th June, 2019**.

If any other internship opportunity offering from *Centre for Robotics, SCMS School of Engineering and Technology* after **June 30, 2019**. I'm ready to join. And I already have 1 year long INDIAN Tourist VISA, so after June 30, 2019 any time I have no

problem to arrive in INDIA. And I'm looking for the next procedure from you.

Best regards,

Md. Ziaul Haque Zim  
Studies B.Sc. in Computer Science And Engineering  
Daffodil International University, Dhaka, Bangladesh.

---

**Dr. Varun G Menon** <varunmenon@scmsgroup.org>  
To: "Md. Ziaul Haque Zim 181-15-11333" <ziaul15-1133@diu.edu.bd>

Tue, Mar 19, 2019 at 12:07 PM

Dear Md. Ziaul Haque Zim,  
Thank you for the message. I will definitely let you know about opportunities at Center for Robotics in future.  
Have a great time in Russia.

Varun

[Quoted text hidden]

--

Thanks and Regards,

**Dr. Varun G Menon**  
Associate Professor, Computer Science Engineering  
ACM Distinguished Speaker  
Corporate Relations and International Collaborations-in charge  
SCMS School of Engineering and Technology  
SCMS Group of Educational Institutions  
Karukutty, Ernakulam, Kerala, India - 683 582  
Office: +91-484-2450330 Mob: +91-8714504684  
Web: <http://www.scmsgroup.org>



---

**Md. Ziaul Haque Zim 181-15-11333** <ziaul15-1133@diu.edu.bd>  
To: "Dr. Varun G Menon" <varunmenon@scmsgroup.org>

Sun, Apr 14, 2019 at 12:28 AM

Dear Sir,  
I'm writing you very late. But I need to know more about this Internship. Is this internship is free of cost? Or I need to pay for something?  
Please reply me with details. Because I found some friend who is interested for this.

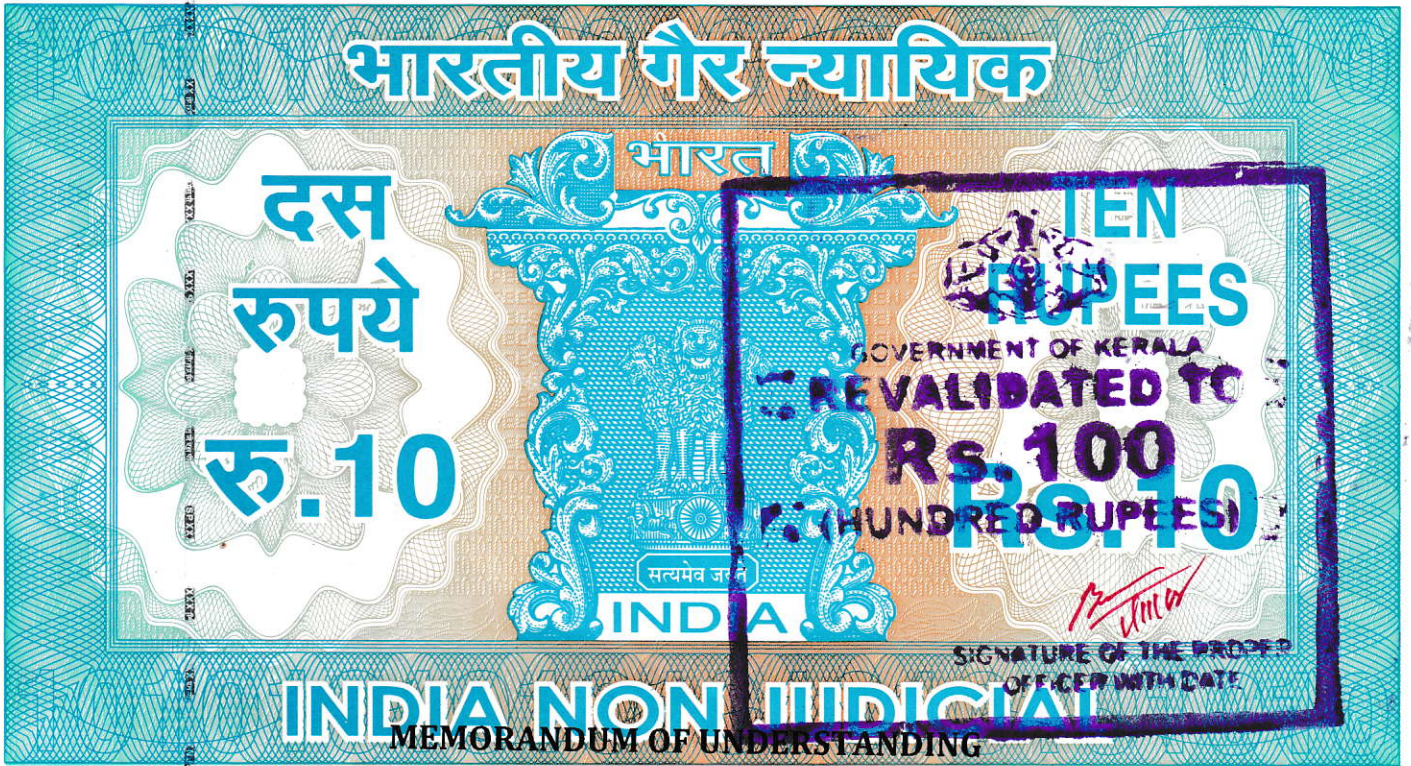

കേരളം കേരल KERALA

25AA 736508

This Memorandum of Understanding ("MoU") is executed on this **20<sup>th</sup> day of December** in the year **Two Thousand and Eighteen** at Kochi by and between;

**Kochi Metro Rail Limited**, a joint venture company of Government of India and Government of Kerala, entrusted for setting up a world-class metro rail system in Kochi, having its Corporate Office at 8th Floor, Revenue Tower, Park Avenue, Kochi-682011, Kerala, India, represented by its Managing Director, Sh. Mohammed Hanish, I.A.S, (hereinafter referred to as "KMRL", which the term shall unless otherwise repugnant to the context shall mean and include all its successors and permitted assigns) on the FIRST PART;

  
 Managing Director  
 Kochi Metro Rail Ltd  
 Kochi-682 011



43762 NO. 7-11-2018 Date

Link.....To.....

Kochi Metro Rail Ltd

LISSY SEBASTIAN  
 CJM Court Vendor, Ekm

Memorandum of Understanding between KMRL & SCMS-WI





കേരളം KERALA

25AA 736509

The **SCMS Water Institute**, a Centre of Excellence on Water, represented by SCMS Group of Educational Institutions, having its registered office at Prathap Nagar, Muttom, Kochi, Kerala, and represented by its Vice Chairman, Sh. Pramod P Thevannoor, (hereinafter referred to as "SCMS", which the term shall unless otherwise repugnant to the context shall mean and include all its successors and permitted assigns) on the SECOND PART.

**KMRL and SCMS are hereinafter collectively referred to as "Parties" and may also be referred to individually as "Party".**

1. The Mission of KMRL is to provide a reliable, safe, efficient, viable and customer friendly mass rapid transit systems for the Greater Kochi Region, which is environmentally and financially sustainable. KMRL also aims at enhancing the quality of life of the people in the region. KMRL wants to implement rainwater-harvesting systems at the metro stations, depot, as well as

43763

NO. 2-11-2018  
Date  
Link

Kochi Metro Rail Ltd.

LISSY SEBASTIAN  
CJM Court Vendor, Ekm.

Memorandum of Understanding between KMRL & SCMS-WI

Managing Director  
Kochi Metro Rail Ltd  
Kochi-682 011

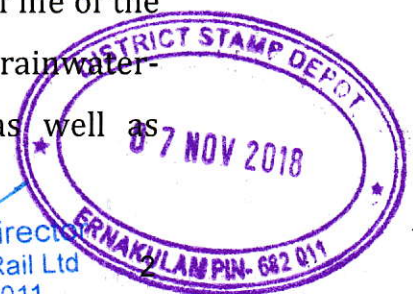

viaducts so as to reduce its dependency on treated water from public distribution network. KMRL looks to carry out a pre-feasibility study on the implementation of rain water harvesting systems at its facilities.

2. SCMS is committed to promote water audit, conservation and management. Over the last few years, SCMS has been providing technical support to Local Self Governments (LSGs) in Kerala in addressing their challenges in managing the water resources.

3. The purpose of this MoU is to establish the basis and structure of a collaboration between the above-mentioned parties to integrate best practices in rainwater harvesting at metro stations and viaducts to ensure water sustainability of Kochi Metro.

## **CLAUSE 1: OBJECTIVES**

- 1.1 To have an integrated, systematic effort to address effective utilization of rainwater collected over metro stations, depot and viaducts.
- 1.2 To reduce the dependency on public water distribution system and to contribute excess water resources to overcome the water scarcity in the city.
- 1.3 To have a comprehensive water management policy for the operations of Kochi Metro.



Memorandum of Understanding between KMRL & SCMS-WI



Managing Director  
Kochi Metro Rail Ltd  
Kochi-682 031

1.4 As a part of achieving the above objectives, SCMS would assist KRML in these specific tasks:

- a. Assess the water use patterns at metro stations.
- b. Provide technical assistance to KMRL in conducting water audit at metro stations.
- c. Quantify the harvestable rainwater and assess feasibility of harvesting at selected locations.
- d. Provide technical assistance for KMRL and associated stakeholders covering all aspects of rainwater harvesting.
- e. Provide technical advisory support to KMRL for the development of a Comprehensive Water Management Policy.

1.5 By mutual agreement between the Parties mentioned above, additional, sustainable water initiatives may be developed under the auspices of this MOU.

## **CLAUSE 2: EXECUTION**

2.1 The KMRL will ensure and coordinate the participation of the staff and other resources. KMRL will nominate a senior officer for the initiatives, who will have the requisite skills, experience and authority to keep the initiative moving forward in a timely manner and who will have direct access to the key decision makers.



Managing Director  
Kochi Metro Rail Ltd  
Kochi-682 011



2.2 The Managing Director / or any of the competent officers of KMRL, who has the decision-making authority under this collaboration, commits to meeting with the representatives of SCMS at major decision points, to discuss options and/or communicate his/her decision to SCMS. Such meetings shall be held at Kochi. No expenditure will be reimbursed to SCMS for attending such meetings.

### **CLAUSE 3: RESPONSIBILITIES OF THE PARTIES**

3.1 This MoU does not involve the transfer of financial resources between the Parties or generate any obligations to either Party to compensate each other in case the actions and programs agreed upon do not take place. Each Party is responsible for its own expenses.

3.2 KMRL and SCMS agree to jointly and individually seek financial resources for the projects under this collaboration from public and private sources. The obligations with personal and/or third parties, assumed by either of the Parties, will not lead to obligations to the other Party and are of sole responsibility of the Party that has assumed them. KMRL agrees to provide SCMS with requisite data, maps, drawings, information, reports, etc. that are necessary for the execution of the objectives as listed in this MoU.



Managing Director  
Kochi Metro Rail Ltd  
Kochi-682 011 5

3.3 KMRL and SCMS agree that all the data provided and study reports created as part of this collaboration can be made available in the general public domain, unless it is specifically agreed mutually that a data or portions of a report need to be held confidential, in the best interest of the human settlements in cities.

#### **CLAUSE 4: DURATION**

4.1 This Memorandum of Understanding has the duration of three years from the date of its execution and can be extended further based on mutual agreement by a written agreement by all Parties.

#### **CLAUSE 5: ALTERATIONS AND ADDITIONS**

5.1 Any alteration of the conditions and clauses established in this Memorandum of Understanding must be agreed and signed by all Parties to this MoU.

5.2 Any issue not defined in the MoU should be agreed formally between the Parties, signed by the Parties, and added to this MoU.



Managing Director  
Kochi Metro Rail Ltd  
Kochi-682 011

**CLAUSE 6: RESCISSION**

6.1 The Memorandum of Understanding can be cancelled by either Party, formally, with a minimum of thirty days' notice, through a written letter or due to a change in law that will not permit its execution.

IN WITNESSTH WHEREOF the parties hereto have set their hands and seal on the day and year first mentioned herein above.

For Kochi Metro Rail Ltd.  
**A.P.M.Mohammed Hanish**  
Managing Director,  
Kochi Metro Rail Ltd.

For SCMS Water Institute  
**Pramod P Thevannoor**  
Vice Chairman, SCMS  
Group of Educational  
Institutions



Witness 1

Name: *Dr. Sunny George*  
*Director, SCMS WATER*  
*INSTITUTE*  
Signature:

Witness 2

Name: *G.P.HARI*  
*Additional GM (Urban Transport)*  
*Kochi Metro Rail Ltd*  
Signature:   
*20/12/2018*



SCMS Water Institute signing MoU with Kochi Metro Rail Corporation (KMRL), Kochi for conducting a feasibility study of the potential of rain water harvesting at the stations of Kochi Metro, viaducts and depot.



**Agreement of Cooperation  
between  
SCMS Group of Educational Institutions  
and  
Hochschule Furtwangen / Furtwangen University of Applied Sciences (HFU)**

In order to extend the effective and mutually beneficial cooperation and develop academic and cultural exchange in education, research and other areas, SCMS Group of Educational Institutions and Hochschule Furtwangen hereby agree to cooperate toward the internationalization of higher education.

The areas of cooperation will include any program offered at either university which is felt to promote the above-mentioned goals. However, any specific program shall be subject to mutual consent, availability of funds and the approval of both universities. Such programs may include:

- a) exchange of faculty members
- b) exchange of students
- c) exchange of publications
- d) joint research projects
- e) joint conferences
- f) joint teaching projects
- g) joint cultural programs.

The terms of such mutual assistance and cooperation shall be discussed and agreed upon in writing by the responsible authority of each university prior to the initiation of any particular program or activity.

This agreement shall take effect upon approval by both parties and shall remain in effect for an initial period of five years. Thereafter it shall automatically be renewed annually. However, either university may terminate the agreement in writing at least ten months prior to the beginning of an academic year.

Cochin, India  
4.09.2015

Prof. Pramod P. Thevannoor  
Vice Chairman  
SCMS Group of Educational Institutions  
Cochin, Kerala, INDIA.



22. SEP. 2015

Prof. Dr. Rolf Schofer  
President  
Hochschule Furtwangen / Furtwangen University  
of Applied Sciences

## **MoU Signing Ceremony - Furtwangen University, Germany & SCMS**

SCMS School of Engineering and Technology renewed MoU with Furtwangen University, Germany. SCMS is having an MoU with University of Furtwangen in order to have students & faculty exchange, joint research, institutional strengthening, etc. This MoU is valid for five years. The new MoU between SCMS and Furtwangen University, Germany were exchanged between P.C Pillai, Group Director, SCMS Group and Prof. Dr. Ulrich Mescheder, Director of Institute for Applied Research, Furtwangen University, Germany; during the inaugural session of International seminar on education, opportunities & life in Europe on August 25th, 2017 at SSET campus.



MoU between SCMS and Furtwangen University, Germany were exchanged between P.C Pillai, Group Director, SCMS Group and Prof. Dr. Ulrich Mescheder, Director of Institute for Applied Research, Furtwangen University, Germany

## **International Seminar on Education, Opportunities & Life in Europe**

Seminar was conducted on August 25th, 2017 at SSET in two sessions.

In the first session Prof. M Madhavan, Principal, SSET gave the welcome address and Dr. Sunny George, Director, SCMS Water Institute presented the objective of this seminar. Presidential Address gave by P.C Pillai, Group Director SCMS Group. SCMS is having an MoU with University of Furtwangen in order to have students & faculty exchange, joint research, institutional strengthening, etc. After Felicitation by Dr. Praveensal C J, Vice-Principal, SSET, the MoU between SSET and Furtwangen University, Germany were exchanged between P.C Pillai and Prof. Dr. Ulrich Mescheder, Director of Institute for Applied Research, Furtwangen University, Germany. Prof Mescheder is an internationally renowned scientist on sensor as well as nanotechnology at Furtwangen University. It's one of the most prestigious universities in Europe. Dr George Thomas is a former Indian student who did his M.Tech and PhD from University of Konstanz, Germany and now working as scientist in Switzerland. Both of them spoke on career journey linking Indo- German- Swiss opportunities in education, research, entrepreneurship etc. It was an invaluable opportunity for students from all disciplines of engineering who are interested to do their M.Tech or Ph D programme in Europe. Dr. Anitha G Pillai, Dean-Academics & Head Department of Civil Engineering gave vote of thanks to the gathering.

In the afternoon session, Prof. Dr. Ulrich Mescheder addressed M.Tech environmental engineering students on latest advancements in sensor as well as nanotechnology in environmental engineering research and business. He gave a brief on Furtwangen University's role in the development of sensor technology and algorithms necessary for the sensor systems, as well as the interface of the sensor technology to the higher level information system and a briefing on general aspects of microtechnology.



Speech by Prof. Dr. Ulrich Mescheder, Director of Institute for Applied Research, Furtwangen University, Germany





Prof. Dr. Ulrich Mescheder, Director of Institute for Applied Research, Furtwangen University, Germany addressing M.Tech students of SSET



Prof. Dr. Ulrich Mescheder, Director of Institute for Applied Research, Furtwangen University, Germany addressing B.Tech students of SSET

Approved by

HOD



## Cooperation Agreement

### Preamble:

Both the institutions **SCMS group** and **SEWERIN** have interests on special fields of water and wastewater technology and it was found out that there could be synergies in working together. The goal of this cooperation between the both parties is to support the training and joint handling of projects in the field of leak detection technologies.

1. This cooperation agreement is established between the following two institutions:

- **SCMS Group of Educational Institutions**

**SCMS Campus**

Prathap Nagar, Muttom

Cochin - 683 106, Kerala, India

Represented by Prof. Pramod P. Thevannoor

Vice Chairman

and

**HERMANN SEWERIN GMBH**

**Robert-Bosch-Straße 3**

**33334 Gütersloh**

Represented by Dr. Swen Sewerin

CEO

2. **SCMS Group** as a private educational institution offers undergraduate and graduate programs in management, business and technology and has R&D activities on various fields. The **SCMS Water Institute (SWI)** is a division of **SCMS Group of Educational Institutions** with the following objectives:

- Developing water and wastewater technologies including reuse of water and recycling of valuable components
- Fine-tuning of given technologies for local conditions
- Framing water policies
- Performing environmental impact assessments and water audits
- Offering water related capacity building on all levels



**SEWERIN**  
Hermann Sewerin GmbH  
Robert-Bosch-Str. 3 - 33334 Gütersloh  
Tel.: 0 52 41 / 9 34 - 0  
Fax: 0 52 41 / 93 44 44

## SEWERIN

SEWERIN is a private, independent and owner-operated company. Our focus lies on developing, producing and distributing worldwide water and gas leak detection instruments.

Our own research, development and production department secures our independence and international pole-position in the field of leak detection technology.

These both institutions are interested in a close cooperation to develop and to adapt approved technologies to the specific tropical conditions. The focus lies on water and pipe location equipment, leak detection in particular.

For the specific project applications separate *Letters of Intend* will be agreed on.

3. The role of the two partners is as follows:

SCMS:

- identification of fields for research and application
- basic investigation for the preparation of research and application projects
- providing of qualified project support by staff or students of SCMS Group

SEWERIN:

- supply of the necessary technical equipment
- providing of qualified project support
- support and training of staff or students

4. Results, which are worked out in common projects will be published or used together, but only upon mutual agreement.
5. All technical information as well as information about projects, which are exchanged in the frame of this cooperation, will be handled confidentially. All rights will stay with the institution which has delivered this information.
6. The cooperation can be terminated from each side to the end of a year by written notice three months in advance.

Cochin, 4.09.2015

(signature/ stamp)

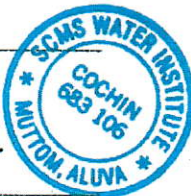

Gütersloh, 10.09.2015

(signature/ stamp)

**SEWERIN**

Hermann Sewerin GmbH  
Robert-Bosch-Str. 3 - 33334 Gütersloh  
Tel.: 0 52 41 / 9 34 - 0  
Fax: 0 52 41 / 93 44 44

## MoU Signing Ceremony - SEWERIN GmbH

An internationally successful and technologically innovative German company which is a world leader in pipe location and water leak detection has MoU with SCMS Group for academic and technological collaboration. Sewerin has donated both leak detection and pipe locating instruments worth several lakhs for SCMS Water Institute. Students and in- service engineers from government are being trained by SCMS Water Institute using these equipment's from SEWERIN GmbH.

- **“Water Pipe Leak Detection and Pipe Tracing”**; by Sewerin GmbH, Germany, September 26, 2016

On September 26, 2016 a workshop on leak detection and pipe locating were conducted at SSET. Dr. Syed Ibrahim, Honorary Consul of Germany in Kerala & Director, Goethe-Zentrum, Trivandrum inaugurated the workshop conducted at SCMS School of Engineering and Technology, Karukutty, Ernakulam and experts from Sewerin were resource persons. These workshops were an example of an academia-industry joint research initiative, where the participants from various sections of the society like water authority, irrigation department, consultants, technicians, NGOs and students got hands on training in the usage and application of leak detection and pipe locating technologies.



Mr. Lutz Höernschemeyer, Manager, Sewerin from Germany conducting training program on leak detection & pipe locating in association with SWI at the 'Joint leak detection training facility' at SSET campus on September 26, 2016

- **“Water pipe leak detection & tracing training”, October 18, 2015**

SCMS Water Institute at SCMS School of Engineering & Technology, Karukutty, Ernakulam enjoys a MoU with SEWERIN GmbH for the training and skill development in the usage of leak detection sensors for monitoring water distribution networks. SCMS School of Engineering and Technology, Karukutty, Ernakulam in collaboration with SEWERIN, GmbH, Germany, a pioneer in leak detection has conducted a training workshop on October 18, 2015 at our main campus to train M.Tech Environmental Engineering students of SSET and donated the state of the art technology sensors to SCMS Water Institute for the mentioned purpose. Hon: Vice Chancellor of KTU was kind enough to accept these equipments from SEWERIN GmbH on behalf of SCMS Water Institute.



Mr. Lutz Höernschemeyer, Manager, Sewerin from Germany giving a demonstration for students of SSET to locate water pipe on October 18, 2015

Approved by

Handwritten signature of the HOD.

HOD

## Cooperation Agreement

### Präambel:

The Institutions **SCMS Group** and **LimCo International GmbH (Limco)** had several meetings in the frame of Indian-German cooperation activities. During the discussions about various technological aspects of water and wastewater it was found out that there could be best synergies in working together. The goal of this cooperation between the both parties is to develop and to apply together best economic and effective solutions in the named fields in research and practical applications, under involvement of staff and students from both sides and from further partners.

- This cooperation agreement is established between the following two institutions:
- **SCMS – School of Engineering and Technology SSET**  
SCMS Campus  
Prathap Nagar, Muttom  
Cochin 683 106, Kerala, India  
represented by Prof. Pramod P. Thevanoor  
Vice Chairman.
- **LimCo International GmbH**  
Blarerstr. 56, 78462 Konstanz, Germany  
represented by the Managing Director Dr. Almut Gerhardt
- **SCMS** group as a private educational institution offers undergraduate and post graduate programs in management, business and technology and has R&D activities on various fields. SCMS Water Institute is an activity of SCMS Group of Educational Institutions at SSET with the following objectives:
  - developing water and wastewater technologies including reuse of water and recycling of valuable components
  - finetuning of given technologies for local conditions
  - framing water policies
  - performing environmental impact assessments and water audits
  - offering water related capacity building on all levels

**LimCo International GmbH** is specialized in the research, development, consulting, education and engineering in the water sector. We especially develop innovative technologies for continuous monitoring of water quality for drinking, surface, re-use and wastewater as well as



**LimCo International GmbH**  
Technologiezentrum Konstanz  
Blarerstr. 56  
D-78462 Konstanz

seawater and aqua/maricultures, such as the Multispecies Freshwater Biomonitor, the LimCo Biosensor System and the new biofilm sensor. We are partner in several national and international applied research projects in aquatic and soil ecotoxicology, we have lecturing contracts with the HTWG Konstanz and we exchange and co-supervise students at different career levels. We also perform consultancies in stream and land fill assessments.

- These both institutions are interested in a close cooperation to develop and apply new technologies and to adapt approved technologies to the specific tropical conditions. The focus is water and wastewater treatment, re-use of water from rain water, aquacultures, etc.

For specific project applications separate Letters of Intend (LoI) will be agreed on.

Following projects could be of interest among others:

- Adapt the Multispecies Freshwater Biomonitor (MFB) to Indian conditions to monitor WWTP effluents, rivers, reservoirs for drinking water, etc.
- Adapt the biofilm sensor to monitor water quality in drinking water tanks and swimming pools  
A goal of the cooperation is to apply the research results on a technical level in practical application in larger scale, e.g. in a pilot WWTP plant of SSET.
- The role of the two partners is as follows:

SCMS:

- identification of fields for research and application
- basic investigation for the preparation of research projects (elaborating of funding sources and proposal writing)
- providing of qualified project support by staff or students of SSET
- performing local research work by applying this technology in India.

LimCo:

- Technology transfer such as demonstration, workshops, lectures
- Technology loan for pilot plants and applications
- Co-supervision of research work and joint publications
- Student exchange and support (both ways)



**LimCo International GmbH**  
Technologiezentrum Konstanz  
Blarerstr. 56  
D-78462 Konstanz



- Results, which are worked out in common research projects will be published or used together.
- All technical information resp. technology as well as information about projects, which are exchanged in the frame of this cooperation, will be handled confidentially. All rights will stay with the institution which has delivered this information resp. technology.
- The cooperation can be terminated from each side to the end of a year by written notice three months in advance.
- The following had been agreed by both partners based on the points mentioned above:

1. SCMS Group shall help LimCo as a Knowledge Partner.
2. Student to come in Spring for 1 month to learn the equipment (covered by project of Prof. Fritsch (BWS), Limco is looking for a room as soon as this is approved).
3. Student works in India on application of the biomonitor in India with a native species (3 months): financed by the locally by SSET.
4. Writing joint research papers for scientific journals.
5. Application for further funding for research in this field in Indian conditions.
6. Joint research, workshops and demonstration of equipment & technology in India.

Cochin,

27/01/2015



(signature/ stamp)

Konstanz,

13.01.2015

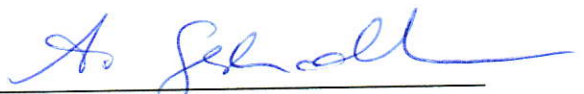

(signature/ stamp)



**LimCo International GmbH**  
Technologiezentrum Konstanz  
Blarerstr. 56  
D-78462 Konstanz

## **LimCo International GmbH, Germany**

LimCo GmbH, an expert in biomonitoring, has given their Automated Multi species Biomonitoring Device costing Rs 8 lakhs to SCMS Water Institute for optimizing and fine tuning the instrument to Indian conditions.



Merin Mathew (2013 admission) student from the first batch of M. tech Environmental Engineering) was selected to undergo advanced training at International GmbH, Konstanz, Germany for a period of five weeks in May 2015. Limco International GmbH is an internationally reputed German company, a consultant in Limcology (science of fresh water). Merin Mathew got training in their worldwide unique IP-protected LimCo BioSensor system (LBS) based on the established Multispecies Freshwater Biomonitor (MFB). After the training, the biosensing equipment was brought to SCMS Water Institute for conducting studies in India and Merin Methew is continuing the project at SCMS Water Institute.



• Linda Joy (2014 admission) of M. tech Environmental Engineering undergone a one month industrial training at Limco International GmbH, Germany from 22<sup>nd</sup> October to 22<sup>nd</sup> November 2015.

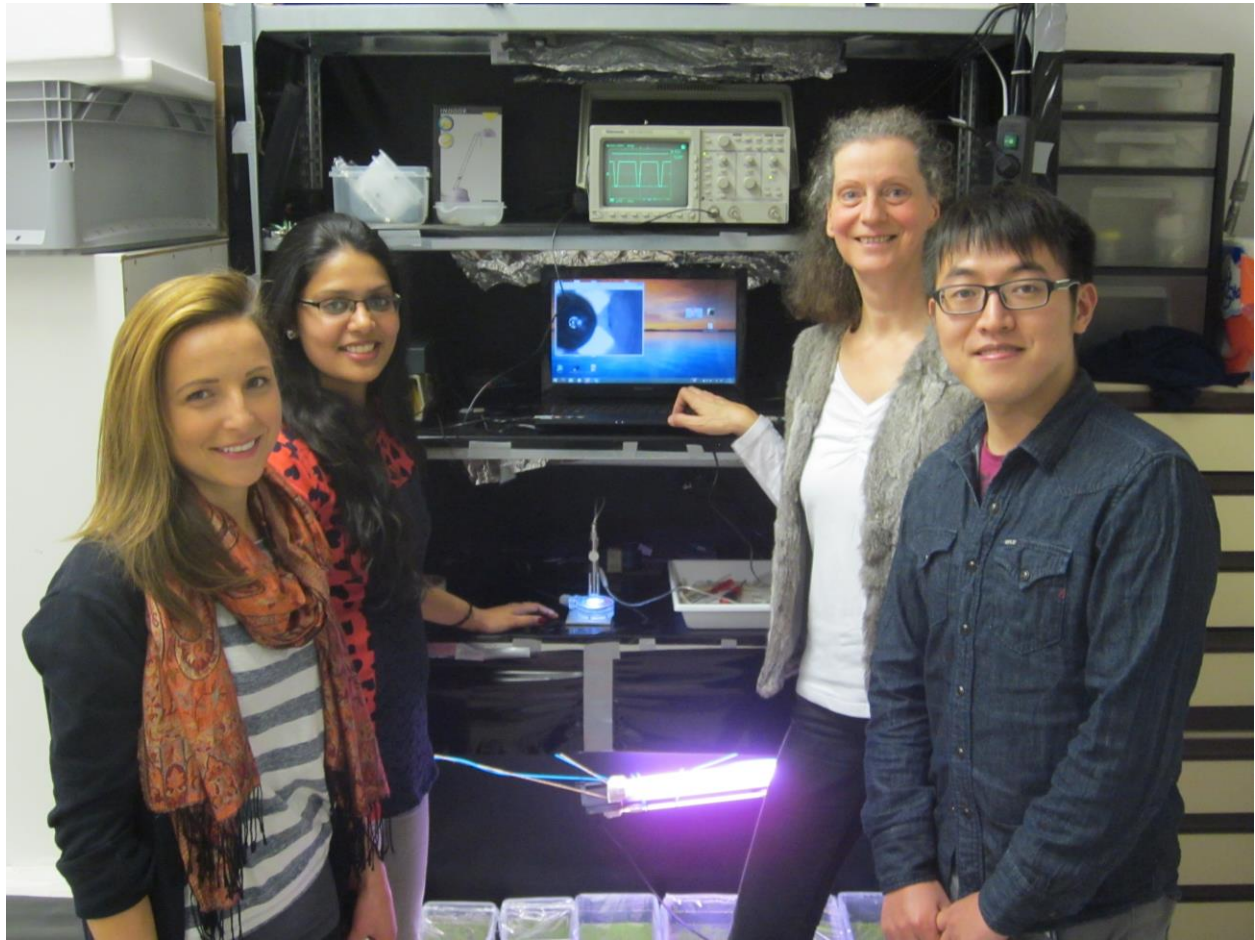

Approved by

HOD

## **Agreement on Partnership and Co-operation**

**Between**

**SCMS-COCHIN**

**SCMS group of Educational Institutions**

**Cochin/India**

**And**

**Hochschule Ravensburg-Weingarten (HRW)**

**Germany**

**SCMS-Cochin of the SCMS group** of Educational Institutions Cochin/India (in the following denoted as SCMS-Cochin) and **Hochschule Ravensburg-Weingarten/Germany** (in the following denoted as HRW) agree to the following terms:

### **1. DEFINITIONS**

In this agreement, unless otherwise stipulated, HOME institution shall mean the institution at which faculty and students intend to teach/graduate. HOST institution shall mean the Institution that has agreed to receive faculty and staff from the HOME institution.

Unless otherwise stipulated, the academic year of SCMS-Cochin means three terms spread between July and April. Likewise, regarding HRW, the academic year means two semesters October to February and March to September.

### **2. PURPOSE**

The objective of this agreement is to establish special relations and cooperation between the two institutions in order to enrich the understanding of the culture of the two countries concerned. This agreement is to make possible and to institute the exchange of undergraduate and graduate students as well as faculty between the institutions on a continuing basis.

The purpose of exchange of faculty members is to promote collaborative research, internationalise the curricula and to further mutual understanding.

The purpose of the student exchange will be to enable students to take units (classes) but not to study for a full period of the degree at the HOST institution. Units passed at the HOST institution will normally be accepted for credit towards the degree of the candidate's HOME institution for which he or she is enrolled. It will be the responsibility of each participant in

the Students Exchange Program to obtain official approval from his or her own institution for units taken at the HOST institution.

### **3. NUMBERS**

#### ***Faculty Exchange:***

Subject to the teaching schedule, SCMS-Cochin will send up to 2 (two) faculty members in each academic year and HRW will send up to 2 (two) faculty members during the duration of the agreement unless amended by mutual agreement. The faculty on exchange will have to essentially teach at least one full course, meeting the total number of contact hours as prescribed by the HOST institution. Both the institutions agree that they will make every effort to schedule the class sessions in such a way as to minimize the stay of the faculty on exchange at their campus. However, each institution will ensure that such rescheduling of class sessions will in no way lead to compressing the course or reduce the minimum prescribed contact hours.

In principle, the exchange of faculty will occur on a one-for-one basis. The number may vary in a given year, but over a fixed period of five years, the total number of faculty participants shall be balanced.

#### ***Student exchange:***

Subject to the availability of suitable candidates SCMS Cochin will send up to 5 (five) students in each academic year and HRW will send up to 5 (five) students in each academic year during the duration of the agreement unless amended by mutual agreement. The period of study will be for one or two trimesters at SCMS Cochin or one or two semesters at HRW. The duration of a period of exchange would normally be up to one year.

In principle the exchange of students will occur on a one-for-one basis. The number may vary in a given year, but over a fixed period of five years, the total number of student participating shall be balanced.

#### ***Organizing International Study weeks***

Both the institutions agree to accept the terms from each other on international study weeks for a maximum duration of two weeks.

### **4. SELECTION OF STUDENTS**

The HOME institution will screen applications from its student body for exchange. The program is available for graduate students who have completed at least one third of the requirements of the graduate program.

Each institution will send the other, completed applications for their students sixteen weeks before the beginning of the entry semester or term. The exchange students may apply to any academic program offered at the respective HOST institution.

The HOST institution will reserve the right to make final judgement of the eligibility of each student nominated. The HOST Institution also retains the right to assess a student candidate's language proficiency (if applicable) or previous academic background before admitting that student to any one course. This may have the net effect of restricting the range of courses at the HOST institution, open to the visiting guest student. All exchange students shall abide by the rules and regulations of the HOST institution.

#### **5. RESPONSIBILITIES OF THE TWO INSTITUTIONS**

SCMS Cochin and HRW agree to accept exchange students from each other and enroll them as full-time "not-for-degree" students for the regular semesters of the academic year. Each institution will provide the necessary counseling and assistance to the exchange students.

#### **6. FINANCIAL RESPONSIBILITIES OF THE TWO INSTITUTIONS**

##### ***Student Exchange:***

Each HRW-student studying at SCMS-Cochin will be provided, without further cost, with:

- Tuition
- Orientation
- Reports and statement of results (transcript)

Each SCMS Cochin student studying at HRW will be provided, without further cost, with:

- Tuition
- Orientation
- Reports and statement of results (transcript)

##### ***Faculty Exchange:***

The financial details of faculty procedures will be as detailed below:

- SCMS Cochin agrees to meet the cost of economy class ticket by the shortest route to Cochin, India for the exchange faculty from HRW
- SCMS Cochin will meet the cost of local transport of the visiting faculty from HRW during their stay at Cochin
- SCMS Cochin will provide accommodation and food to visiting faculty from HRW at its guest house located on campus during their stay at Cochin. However, if the visiting faculty decides to make any alternative arrangement for accommodation elsewhere it will be at their cost.

- SCMS Cochin and HRW will, in addition to all the above and as it is the practice in similar exchange arrangements with other international institutions, pay each visiting faculty for every full credit course taught by them amounts mutually agreed by the two institutions

The participating institutions shall not be responsible for any private arrangements made by participating staff members concerning exchange of accommodation and vehicles. It is not anticipated that spouses or dependents will accompany a faculty member. Where such arrangement is planned it is understood that additional expenses are the responsibility of the faculty member.

## **7. FINANCIAL RESPONSIBILITY OF EXCHANGE STUDENTS**

Each student participating in the exchange program shall meet the full costs related to:

- Travel to and from India and Germany and vice versa as the case may be
- Books and stationery
- Travel documents and visa
- Living and subsistence expenses as an exchange student
- Application or related fees for participating in the program as may be charged by the HOME institution
- The cost of health and/or medical insurance at the HOST institution and the HOST country

The HOME institution shall satisfy itself that the nominated student has met the financial conditions stipulated before granting acceptance.

The HOST institution shall render all assistance to the student in seeking accommodation within reasonable distance of the campus

Where a student spends more than one semester or term at a HOST institution by enrolling in parts of two academic years, the student must have the funds to cover living and subsistence costs over the summer and/or winter break.

## **8. SCMS WATER INSTITUTE**

As a project of collaborative research the

### **SCMS Water Institute (SWI)**

has been founded in February 2012 at SCMS Cochin, at the beginning under the name "Centre of Sustainable Water Technology and Management"

The objectives of SWI are the following:

- developing water and wastewater technologies including reuse of water and recycling of valuable components

- finetuning given technologies for local conditions
- framing water policies
- performing environmental impact assessments and water audits
- offering water related capacity building on all levels
- taking up demand driven initiatives on a consultancy basis

Students and staff of both institutions being the main actors to meet these objectives, these activities of the SWI are included into the agreement.

The details of the structure and organization of SWI, both on side of SCMS group and on side of HRW, have been developed in the last years and will be improved further.

The fact of this cooperation between the two institutions can be used by both institutions in their external communication.

For student or staff exchange within common projects of the two institutions under the SWI scheme, each institution will cover the costs for travelling and the expenses of living of its own members. There will be no financial transfer between the institutions for establishing the necessary infrastructure of the institute.

## **9. TERMS OF AGREEMENT AND AMENDMENT**

This agreement shall remain in force for a period of **5 (five) years from 10<sup>th</sup> December 2015** with the understanding that it may be revised, terminated or suspended pending availability of places by either party giving six months written notice to the other party and in a manner that the student(s) participating in the exchange scheme is in no way adversely affected.

Either party may terminate the Agreement at any time during the term by the provision of six months written notice to the other party.

## **10. GENERAL**

SCMS Cochin and HRW shall undertake all the measures as are seen reasonable to give maximum effect to this exchange program. Such actions will include the exchange of academic handbooks, newsletters and promotion material.

SCMS Cochin and HRW will be responsible for regular review of the exchange program on a yearly basis. The review is essential to make appropriate and mutually agreed modifications as may be required, and to identify new opportunities of cooperation in scholarship and research.



**11. SIGNATURES**

This agreement constitutes the entire agreement between the parties. There are no understandings, agreements, or representations, oral or written, not specified herein regarding this agreement. No amendments, consent, or waiver of terms of this agreement shall bind either party unless writing and signed by all parties. Any such amendment, consent, or waiver shall be effective only in the specific instance and for the specific purpose given. SCMS Cochin and HRW by signature of their authorized representatives below, acknowledge having read and understood the agreement and agree to be bound by these terms and conditions.

For and on behalf of SCMS Cochin

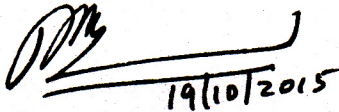
Handwritten signature in black ink, consisting of a stylized 'P' followed by a horizontal line and a flourish. Below the signature, the date '19/10/2015' is written in black ink.

Prof. Pramod Thevanoor  
Vice-Chairman

Date:

Witness

For and on behalf of Hochschule Ravensburg-Weingarten

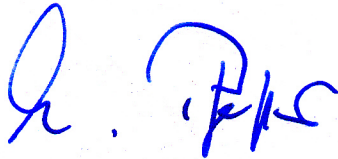
Handwritten signature in blue ink, consisting of a stylized 'M' followed by a horizontal line and a flourish.

Prof. Dr. Michael Pfeffer  
Vice Rector Research and International Relations

Witness: Prof. Dr. Johannes Fritsch  
International Coordinator  
Energy and Environmental Engineering

## **UNIVERSITY OF APPLIED SCIENCES RAVENSBURG-Weingarten, Germany**

SCMS Water Institute (SWI) at SSET has Memorandum of Understanding with University of Applied Sciences, Ravensburg-Weingarten in order to develop SWI into a Centre for Excellence in water within the coming few years. A project named “Establishment of a Centre of Competence on Water and Waste Water” has been sanctioned by Württemberg-Stiftung, Stuttgart, Germany for this purpose.

This project includes:

- Joint research on different mechanisms on membrane separation named Low Energy Electro dialysis, Forward Osmosis, Effluent Water Treatment etc.
- Faculty and Student Exchange
- Strengthening of the M. Tech Environmental engineering course at SSET.
- Institutional strengthening
- Automation in water treatment.

SCMS Group has various collaborations with this university since 2010. SCMS Water Institute itself is fruit of this collaboration initiative. Two visionaries namely, Prof Dr Johannes Fritch of University of applied sciences, Ravensberg- Weingarten, Germany and late Prof Dr. Pradeep P Thevannor, then Vice Chairman of SCMS Group were the key persons initiated this collaborative mission. As per the MoU between these two institutions, joint research, student and faculty exchange, institutional strengthening etc are the main aims of this technical collaboration.



Prof Pramod P Thevanoor, Vice Chairman of SCMS Group, in the presence of Honourable Mr Jorn Rhode, Consul General of Germany in Bengaluru, and Shri. K M Chandrasekhar IAS (Retd), Vice Chairman, Kerala State Planning Board signing the MoU with Prof. Dr. Michael Pfeffer, Vice Rector, University of Applied Science, Ravensburg-Weingarten on October 19, 2015

Aleena James, Ashly Mary Mammen and Neenu Georgina Johnson (2013 admission) of M. Tech Environmental Engineering at SSET had been at University of Applied Sciences Ravensburg-Weingarten, Germany, as part of the student exchange programme between University of Applied Science Ravensburg-Weingarten and SSET during November – December 2014.



Approved by

**HOD**



## Cooperation Agreement

### Preamble:

Both the institutions SCMS Group and NIVUS have interests on special fields of water and wastewater technology and it was found out that there could be synergies in working together. The goal of this cooperation between the both parties is to support the training and joint handling of projects in the field of flood prevention, new technologies and protection of the environment. We are focussing especially on flow measurement technologies.

1. This cooperation agreement is established between the following two institutions:

• **SCMS School of Engineering and Technology (SSET)**

SCMS Campus  
Prathap Nagar, Muttom  
Cochin 683 106, Kerala, India  
Represented by Mr. Pramod P. Thevannoor  
Vice Chairman

and

**NIVUS GmbH**

Im Täle 2  
75031 Eppingen  
Represented by Mr. Schmalz and Mrs. Vondenhof

2. **SCMS** Group as a private educational institution offers undergraduate and graduate programs in management, business and technology and has R&D activities on various fields. SCMS Water Institute is a division of SCMS Group of Educational Institutions at SSET with the following objectives:

- Developing water and wastewater technologies including reuse of water and recycling of valuable components
- Fine-tuning of given technologies for local conditions
- Framing water policies
- Performing environmental impact assessments and water audits
- Offering water related capacity building on all levels

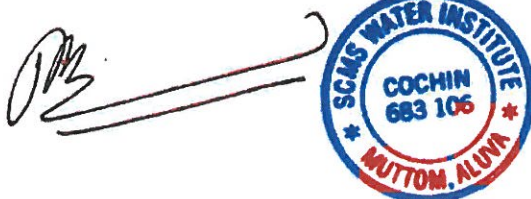

## NIVUS

NIVUS is a private, independent and owner-operated company.

Our focus lies on measurement technology for water and wastewater using the ultrasonic technology.

Our own investigation, development and production department secures our independence and international pole-position in the field of flow measurement technology.

These both institutions are interested in a close cooperation to develop and apply new technologies and to adapt approved technologies to the specific tropical conditions. The focus is water and wastewater technology, flow measurement in particular.

For the specific project applications separate *Letters of Intend* will be agreed on.

3. The role of the two partners is as follows:

SCMS:

- identification of fields for research and application
- basic investigation for the preparation of research and application projects
- providing of qualified project support by staff or students of SSET

NIVUS:

- supply of the necessary technical equipment
- providing of qualified project support
- support and training of staff or students

4. Results, which are worked out in common projects will be published or used together, but only upon mutual agreement.
5. All technical information as well as information about projects, which are exchanged in the frame of this cooperation, will be handled confidentially. All rights will stay with the institution which has delivered this information.
6. The cooperation can be terminated from each side to the end of a year by written notice three months in advance.

Cochin, 4.09.2015

(signature/ stamp)

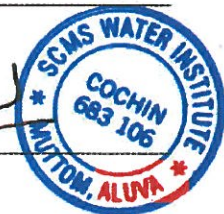

Eppingen, 04/09/2015

(signature/ stamp)



Im Tale 2 • D-75031 Eppingen  
Tel. +49 (0)7262 9191-0  
Fax +49 (0)7262 9191-999  
Internet: www.nivus.de

## MoU Signing Ceremony - NIVUS GmbH

NIVUS is another company having remarkable association with SCMS Group. NIVUS which is an internationally reputed company in ultrasonic flow measurements, has provided equipment's worth several lakhs for SCMS Water Institute for technical teaching, demonstration and training purposes.



SWI team and SSET students conducting field studies and projects using the instruments sponsored by NIVUS GmbH, Germany to SWI

## SCMS brings sensor to rate water loss in transit

SMITHA N. | DC  
KOCHI, FEB. 21

Transmission loss of water is a term Kerala, facing an acute drought, will have to grapple with now, and the SCMS Water Institute at SCMS School of Engineering, Karutty, has come up with an ultrasonic sensor which can help measure it.

The sensor can automatically assess water velocity, water level, depth of water body and quantity of water discharged and help quantify the water loss.

"The real-time measurements along with satellite remote sensing data of the area will help estimate the demand, supply and deficit," said Dr. Sunny George, director of SCMS Water Institute. "It will be helpful in preparing and implementing an effective water management system. It will also improve water use efficiency in the canal network."

A recent survey conducted by the students of the institute on various stretches of Chalakudy river diversion canal network revealed that a huge



SCMS students testing the ultrasonic sensor.

quantity of water is lost mainly through the unlined parts of the canal and unauthorised pumping to nearby areas. The total discharge at Ezhattumugham, where the right bank canal starts, was measured to be 4,700 litres per second while the measurements at Edalakkad junction, about 5.5 km downstream, showed a discharge of 2,000 litres per second. This means about 2,000 litres of water is lost during the transit.

Though the irrigation department has no actual data on the quantity of water transmission loss, an earlier study conducted by the Kerala Agricultural University in Palakkad had found that though targeted efficiency of canal irrigation system is more than 80 per cent, actual efficiency was only 40 to 60 per cent. As per the Directorate of Economics and Statistics, the net irrigated area in the state as on March 31, 2015 is 4.14 lakh hectares.



**Two German technologists who are international experts on Environmental Hydraulics provided training for MTech Environmental Engineering students of SSET on 07-02-2018**

Approved by

HOD